

# SIMPLEX



## KEYLESS CONVENIENCE

**Security—without the headache of key management.** Issuing, replacing and controlling keys can be a headache for both large and small facilities. Kaba's® Simplex® mechanical push-button locks eliminate those headaches by using a PIN code instead of keys for access by all authorized users. One code—that's all you have to remember or keep up with—nothing tangible like a key or magnetic card, no batteries to replace in the lock, and no software or computers to control the lock's operation.

**Simple as 1-2-3.** PIN codes are made up of any combination of one to five numbers (pressed individually or simultaneously). The locks allow thousands of possible PIN code combinations. PIN codes are quickly and easily changed without removing the lock from the door. Eliminates normal expense associated with the issue, control, and collection of keys and magnetic cards.

**All buildings, large or small.** Mechanical push-button locks are a great solution for controlling access between public and private areas. The locks are ideal for locations with regular personnel turnover, like data processing centers, employee entrances, research labs, apartment complexes, and dormitories. They perform nicely in conjunction with other security access systems, or as stand-alone security alternatives in smaller building applications.

### SIMPLEX 1000 SERIES HEAVY DUTY LOCK

- Conforms with ANSI A156.2, Grade 1.
- 3-hour UL/ULC Fire rating for "A" label doors.
- Highly weather resistant.
- Vandal resistant, 5 button
- **3-year warranty.**

### To Order, Specify:

Stock No: **SI-1021- Entrance**  
 \*Core Type: **B For Best Type Core**  
 Finish: **26D Satin Chrome**  
**-41**

Core not required on 1011 or 1031 function

### \*SPECIFY CORE TYPE-

- B**-Best, Arrow
- C**-Corbin.Russwin
- S**-Schlage

Cores not furnished—we stock Arrow cores w/Best Keyways and Schlage cores

### STOCK NUMBERS & FUNCTIONS

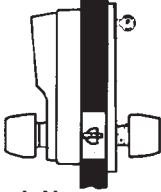
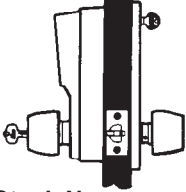
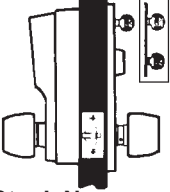
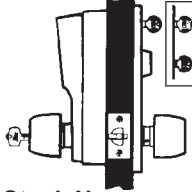
 <p><b>Stock No.</b> <b>SI-1011</b> Standard model. Access by combination.</p>	 <p><b>Stock No.</b> <b>SI-1021*</b> Access by combination or key bypass.</p>	 <p><b>Stock No.</b> <b>SI-1031</b> Access by combination or passage feature. (Passage feature controlled by thumbturn or key-determined at installation)</p>	 <p><b>Stock No.</b> <b>SI-1041*</b> Access by combination, key bypass or passage feature. (Passage feature controlled by thumbturn or key-determined at installation)</p>
---	--	--	--

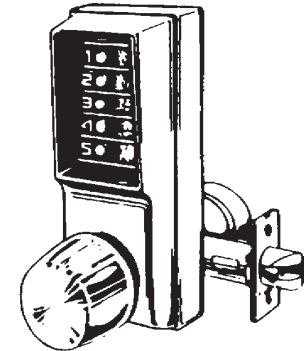

**Combination Code:** One code per lock made of any combination of one to five numbers (pressed individually or simultaneously). **Number of Combinations:** Thousands of possible combinations. **Emergency Access:** Optional mechanical key override.

### SPECIFICATIONS

<b>Lock Body:</b>	Height 7-3/8" x Width 3-1/8" x Depth 3-13/16"
<b>Backset:</b>	2-3/4"
<b>Throw:</b>	1/2"
<b>Strike:</b>	ASA and standard strike included
<b>Door Thick.:</b>	1-3/8" to 2-1/4"
<b>Minimum Stile:</b>	5"
<b>Finishes:</b>	<b>03</b> Bright Brass <b>05</b> Antique Brass <b>26D</b> Satin Chrome

### A NOTE ABOUT THE PASSAGE FUNCTION—

When activated by an inside thumbturn or key cylinder, the outside knob can be set to open the lock without the need for using the pushbutton combination. Designed for use in offices, etc., when the door is to be left unlocked for extended periods.

# SIMPLEX

## SIMPLEX LI000 SERIES HEAVY DUTY LOCK



- Conforms with ANSI A156.2, Grade 1.
- 3-hour UL/ULC Fire rating for "A" label doors.
- Meets A.D.A. accessibility standard.
- Highly weather resistant.
- Vandal resistant, 5 button
- **3-year warranty.**

<b>Stock No.</b>	<b>Handing</b>
SI-LL1011-	Left Hand
SI-LR1011-	Right Hand
SI-LL1021*	Left Hand
SI-LR1021*	Right Hand
SI-LL1031-	Left Hand
SI-LR1031-	Right Hand

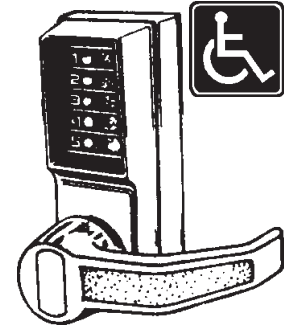

**\*SPECIFY CORE TYPE-**  
**B**-Best, Arrow  
**C**-Corbin.Russwin  
**S**-Schlage

Cores not furnished-we stock Arrow cores w/Best Keyways and Schlage cores

### FUNCTIONS

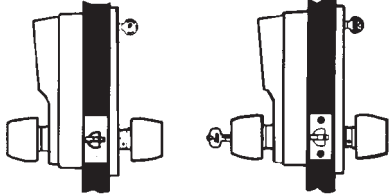

**SI-L 1011** (Lever) Standard model. Access by combination.  
**SI-L 1021\*** (Lever) Access by combination or key bypass.

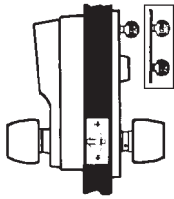

**Stock No. SI-L1031** (Lever)  
 Access by combination or passage feature. (Passage feature controlled by thumbturn or key-determined at installation)

### To Order, Specify:

Stock No: **SI-LR1021-** Entrance  
 \*Core Type: **B** For Best Type Core  
 Finish: **26D** Satin Chrome  
**-41**

Core not required on 1011 or 1031 function

### SPECIFICATIONS

**Lock Body:** Height 7-3/8" x Width 3-1/8" x Depth 3-13/16"  
**Backset:** 2-3/4"  
**Throw:** 1/2"  
**Strike:** ASA and standard strike included  
**Door Thick.:** 1-3/8" to 2"  
**Minimum Stile:** 5"  
**Finishes:** **03** Bright Brass, **05** Antique Brass, **26D** Satin Chrome

## SIMPLEX EEI000 SERIES HEAVY DUTY LOCK



- Conforms with ANSI A156.2, Grade 1.
- 3-hour UL/ULC Fire rating for "A" label doors.
- Highly weather resistant.
- Vandal resistant, 5 button
- **3-year warranty.**



**ACCESS CONTROL FROM BOTH SIDES OF THE DOOR**

### SPECIFICATIONS

**Lock Body:** Height 7-3/8" x Width 3-1/8" x Depth 3-13/16"  
**Backset:** 2-3/4"  
**Throw:** 1/2"  
**Strike:** ASA and standard strike included  
**Door Thick.:** 1-3/8" to 2"  
**Minimum Stile:** 5"  
**Finishes:** **26D** Satin Chrome

<b>Stock No.</b>	<b>Description</b>
SI-EE1011/EE1011-26D	Combination entry/egrees (special order)
SI-EE1021B/B-26D-41	Combination/Key bypass for entry/egress
SI-EE1021S/S-26D-41	Combination/Key bypass for entry/egress
<b>B</b> -for use with Best type cores, <b>S</b> -for use with Schlage full size core	

**Combination Code:** One code per lock made of any combination of one to five numbers (pressed individually or simultaneously). **Number of Combinations:** Thousands of possible combinations. **Emergency Access:** Optional mechanical key override.

**Need a core for your lock?? Just let us know when ordering.**  
**Need the core keyed?? Just let us know when ordering.**

# SIMPLEX

## E-PLEX E2000 SERIES ELECTRONIC ACCESS CONTROL

- ANSI/BHMA A156.2, Grade 1 Certified.
- 100 access codes - including user and service levels.
- Cylindrical latch. Metal, vandal-resistant keys.
- Simple to install and maintain. No wiring.
- Easy to manage - no software required.
- Non handed - field reversible.
- **2-year warranty. Built-in warranty counter.**

# E-PLEX®

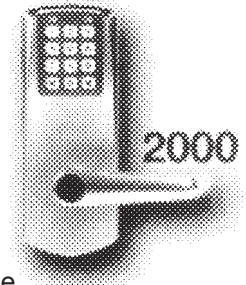

**Stock No.**

**SI-E2031-LL-626-41**

**SI-E2031-XS-LL-626-41**

**Description**

No key override

With key override -Schlage C kwy

**Easy to install:** The E-Plex 2000 easily installs on wood or metal doors with ASA 161 door prep. Three through bolts secure the lock to the door. Requires no wiring to or through the door. Eliminates risk of damage from pinched wires that can result in costly callbacks. Rugged and weather-resistant external housing can be mounted outdoors and includes installation gasket.

**Easy to manage:** With the E-Plex 2000 users and locks are easily managed at the door with simple keypad programming. Multiple operation modes include PIN entry, passage and lockout. Passage mode can be activated by authorized user with assign PIN and pre-programmed to re-lock after a certain number of hours. Four authority levels give you control over who has access to various lock functions.

**Easy to use:** The user friendly design is equipped with ADA compliant levers. Programmable user parameters customize the lock to the needs of different access points. Audio and visual indicators notify users when access is granted or denied. User access code length can be set from 4 to 8 digits. Time interval between combination entry and relocks is variable from 2 to 20 seconds. Anti-tamper feature disables the lock after multiple invalid combination entries—set for between 3 to 9 attempts and up to 90 seconds. **3 AA batteries provide at least 100,000 cycles.**

## SIMPLEX 5000 SERIES EXTRA HEAVY DUTY LOCK

- ANSI/BHMA A156.2, Grade 1 Certified.
- 3-hour UL/ULC Fire rating for "A" label doors.
- Meets A.D.A. accessibility standard.
- Highly weather resistant.
- Vandal resistant, 5 button
- **3-year warranty.**

**To Order, Specify:**

Stock No: **SI-5021-XK-WL-** Entrance

Finish: **26D Satin Chrome**

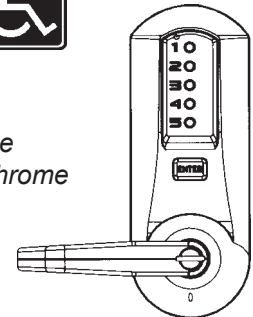

**SPECIFICATIONS**

**Lock Body:** Height 8-7/8" x Width 3-3/8" x Depth 3-3/8"  
**Backset:** 2-3/4"  
**Throw:** 1/2"  
**Strike:** ASA and standard strike included  
**Door Thick.:** 1-3/8" to 2-1/4"  
**Minimum Stile:** 5"  
**Finishes:** **26D** Satin Chrome

**Stock No.**

**SI-5021-XK-WL-**

**SI-5021-XS-WL-**

**\*SI-5021-B-WL-**

**\*SI-5021-S-WL-**

**Key Override**

Key-in-Lever Kaba 90 Keyway

Key-in-Lever Schlage C Keyway

Best & compatibles (core not included)

Schlage I/C (core not included)

\*Special order. Please specify if core required.

Ideal for high-traffic security-sensitive area where access control is required. **Combination Code:** One code per lock made of any combination of one to five numbers (pressed individually or simultaneously). **Number of Combinations:** Thousands of possible combinations. **Code Changing:** Accomplished with the lever release combination change tool from the lock exterior (5021) or from the interior (5031-special order). **Emergency Access:** Mechanical key override.

• SEE NEXT PAGE FOR E-PLEX E5000 SERIES •

# SIMPLEX

## E-PLEX E5000 SERIES ELECTRONIC ACCESS CONTROL

- ANSI/BHMA A156.2, Grade 1 Certified.
- 3-hour UL/ULC Fire rating for "A" label doors.
- Meets A.D.A. accessibility standard.
- Both housings are weather resistant.
- Four bolt installation - **no wiring**.
- Non handed - field reversible.
- **3-year warranty. Built-in warranty counter.**

# E-PLEX®



### SPECIFICATIONS

**Backset:** 2-3/4"  
**Throw:** 1/2"  
**Strike:** ASA and standard strike included  
**Door Thick.:** 1-3/8" to 2-1/4"  
**Minimum Stile:** 5"  
**Finishes:** 26D Satin Chrome

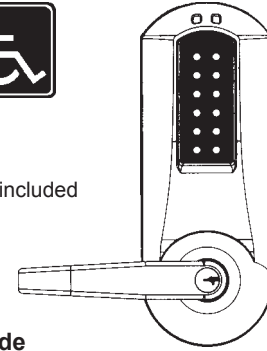

Height:  
8-7/8"  
Width:  
3-3/8"

### Stock No.

**SI-E5031XK-WL-626**

### Key Override

Key-in-Lever Kaba 90 Keyway

The E-Plex 5000 Series combines the strength, simplicity and reliability of Simplex® mechanical push-button locks with the added security and features of electronic access control - it's never been easier to Power Up your access control. Controls access with up to 100 access codes. Exterior access is by combination or key override, and egress is by interior lever and is free at all times.

**Applications:** Ideal for controlling access to security sensitive areas in commercial, industrial, educational, governmental, healthcare, lodging, and multi-unit residential settings. It's perfect for restricted areas with a high user turnover rate.

**Keyless convenience:** Eliminates problems and costs associated with issuing, controlling, and collecting keys and magnetic cards.

**Flexible operational modes:** Combination (PIN) entry, Passage (programmable), Lockout.

**Easy to manage:** User access programmed at the lock or managed with **optional** Microsoft Excel™ based software. Users quickly added and deleted. Optional software provides increased control as facility's users and access points increase. Five authority levels allow you to control user's access to various lock functions: Master, Manager, User, Service and Maintenance. Service level has authority to gain access once, or programmed for 1 to 24 hours - for service personnel, meeting rooms, and rental space.

**Extensive audit trail for added security:** Lock records last 3,000 events for user accountability. Audit includes mechanical key override use.

**Flexible user preferences:** Adjustable anti-tamper lockout disables lock after 3 to 9 invalid entry attempts for up to 90 seconds. Adjustable relock time after combination entry from 2 to 20 seconds. Variable length access codes set from 4 to 8 digits.

**Additional Specifications:** (4) four AA Alkaline batteries-located in interior housing; Battery life up to 180,000 cycles; Lock data is retained if batteries fail; audible and visual indicators; low battery visual indicator.

## SIMPLEX 2015 SERIES EXIT DEVICE CONTROL

- Highly weather resistant.
- Vandal resistant, 5 button
- 1-year warranty.

### SPECIFICATIONS

**Lock Body:** Height 8-5/8" x Width 3-1/8" x Depth 2-3/4"  
**Tailpiece:** 2-3/4" tailpiece for exit device operation from outside  
**Door Thick.:** 1-3/8" to 2-1/2"  
**Handing:** For non-handed or clockwise-rotating exit device hubs only (adjustable up to 90°)  
**Minimum Stile:** 5"  
**Finishes:** 26D Satin Chrome



6-pin tumbler cylinder keys for combination change access. Keyed Different.

Exit device & handle not included. Order separately.

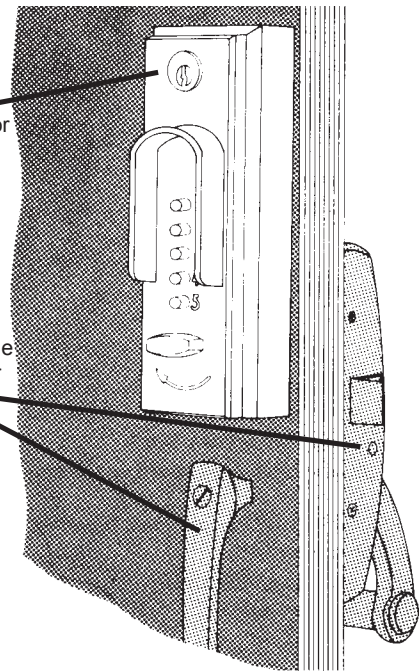

### Stock No.

**SI-2015-26D-41**

### Finish

Satin Chrome

### EXIT DEVICE COMPATIBILITY:

**Von Duprin:** 22, 22F, 88, 88F, 98, 98F, 99, 99F RIMS; 2227, 2227F, 9827, 9827F, 9847, 9847F, 9927F, 9947F.

**American Device:** 6300, 6303.

**Detex Advantex Series:** 10, 20, 21, 40, 50, 51.

**Monarch:** 18RBA, 18RP, 18VP, F18RBA, F18RP, F18VP, FXXRBA, FXXRP, FXXVP, XXRBA, XXRP, XXVP

**Yale:** 1500, 7000.

**Corbin:** 21, 22, 25, 26NT, 27K, 29, 29-1/4, 29M2, 29-1/2M2, 29NTM2, 29D20, LA29, 39, 39EL, 39LLD, 390, LA39.

**Russwin:** 365, 3651/4, LT365, 370, 372, LA372, 375, LT375, 377, 382, 384, 385, 388, 572, 572EL, 572ELD, U572, LA572.

**Sargent:** 2813, 2804, 6804, 12-6804, 9804RHRB, 12-9804LHRB, 9898E, 9898K.

©ZIPF LOCK COMPANY

220 v1

(PL-13)

# SIMPLEX

**Application**—Model LP1000 and 2015(next page) exit device controls are designed to operate surface mount (rim-mounted) exit devices from the outside using a tailpiece, which replaces the key cylinder on new or existing devices. Any standard pull can be mounted with model 2015. They provide exterior access by combination, while allowing free egress at all times by interior exit device. The locks can be used with many leading brands of surface-mounted (rim-mounted) exit devices.

## SIMPLEX LP1000 SERIES EXIT DEVICE OPERATOR

- Conforms with ANSI A156.2, Grade 1.
- 3-hour UL/ULC Fire rating for "A" label doors.
- Highly weather resistant.
- Vandal resistant, 5 button
- **3-year warranty.**

### SPECIFICATIONS

**Lock Body:** Height 8-3/4" x Width 4-3/8" x Depth 3-7/8"  
**Tailpiece:** 2-3/4" tailpiece for exit device operation from outside  
**Door Thick.:** 1-3/8" to 2-1/4"  
**Handing:** Handed, not reversible  
**Minimum Stile:** 5"  
**Finishes:** 26D Satin Chrome

### EXIT DEVICE COMPATIBILITY:

**Von Duprin:** Exit Only (EO) or Exit Only Fire (EOF) 22, 88 NL, 98, 99, 9857, 9957.  
**Detex Advantex Series:** 10, 20, 21, 40, 50, 51.  
**Dorma:** 9100, 9300, 9400.  
**Monarch:** XXR\*, FXXR\*, 18R\*, F18R\*, XXV\*, FXXV\*, 18V\*, F18V\*.  
 (\*Requires special K adapter)  
 Can not be used with mortise design or most vertical rod exit device.

**Need a core or exit device??  
Just let us know.**

LP1000 Series can not be used with mortise design and most vertical rod exit devices.

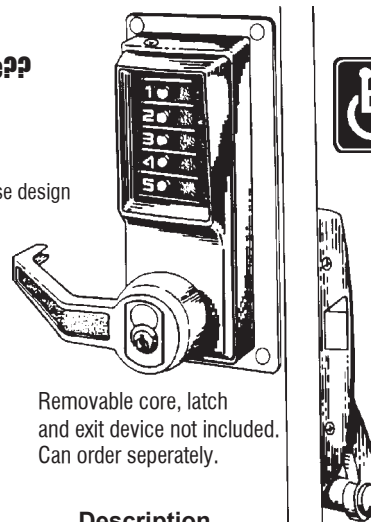

Removable core, latch and exit device not included. Can order separately.

### Stock No.

**SI-LLP1020B-26D-41**

### Description

Left Hand, For Best type core

**SI-LRP1020B-26D-41**

Right Hand, For Best type core

**SI-LLP1020S-26D-41**

Left Hand, For Schlage full size core

**SI-LRP1020S-26D-41**

Right Hand, For Schlage full size core

**Application**—Model 3000 series locks provide fully mechanical pushbutton access control for narrow stile aluminum glass doors. It provides exterior access by combination or key override, while allowing free egress at all times.

Model 3000 series is designed for use with Adams Rite 4510/4710 latch mechanisms and most Adams Rite egress hardware (order separately). Any standard MS mortise cylinder that operates the Adams Rite latch will function with the 3000 series lock. Suitable for inswing and outswing doors.

## SIMPLEX 3000 SERIES NARROW STILE LOCKS



- Highly weather resistant.
- Vandal resistant, 5 button
- 1-year warranty.

### SPECIFICATIONS

**Lock Body:** Height 9-5/8" x Width 1-17/32" x Depth 2-5/8"  
**Backset:** 3010, 3020 31/32"; 3030, 3040 1-1/8"  
**Stile Width:** 1-7/8" minimum required for mounting  
**Door Thick.:** 1-3/4" maximum

### Features:

**Key override** can be used to override the lock combination and gain access using a key. This feature allows facilities to initiate or maintain a master-keyed security system. The lock accepts MS (maximum security) mortise cylinders.

**Passage (latch holdback)** allows access without using the lock entry code, keeping the door unlocked. This feature is activated from the outside with a key.

**Lockout** disables the lock so that entry codes cannot be used to gain access. Access is permitted using the key override only. This feature is activated from the outside using the override key.

You must order housing and drive assembly for complete lock

LATCH NOT INCLUDED  
Order separately.

CYLINDER NOT INCLUDED  
Order separately.

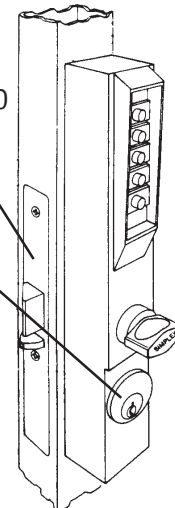

### Housing—

#### Stock No.

**SI-3001-26D-41**

#### Finish

Satin Chrome

**SI-3001-55-41**

Duranodic

### Drive Assembly—

#### Stock No.

**SI-3010-19-41**

#### Backset and Handing

31/32" backset RH or RHRB

**SI-3020-19-41**

31/32" backset LH or LHRB

**SI-3030-19-41**

1-1/8" backset RH or RHRB

**SI-3040-19-41**

1-1/8" backset LH or LHRB

©ZIPF LOCK COMPANY

# SIMPLEX

## SIMPLEX 900 SERIES LIGHT COMMERCIAL/ RESIDENTIAL LOCK



### Deadbolt Function—

To open from outside, press combination and turn front knob to open. The lock remains open (bolt retracted) until either the inside lever or outside knob is turned to throw bolt into locked position.

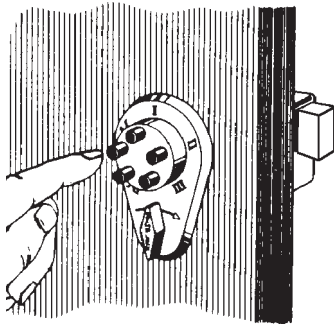

### **SPECIFICATIONS**

**Backset:** Outswing door: 2-9/16"  
Inswing door: 2-1/2"  
**Latch:** On Deadbolt lock 1"  
**Keypad:** Vandal resistant, 5 button.  
**Handing:** Field reversible latch. Invert lock for right hand door.  
**Bore:** 1-5/8" for barrel, 3/4" for thumbturn, 7/8" for key override

**\*Door Thickness:**  
1-3/8" for 1-3/8" to 1-1/2" thick doors  
1-3/4" for 1-3/4" to 2-1/8" thick doors

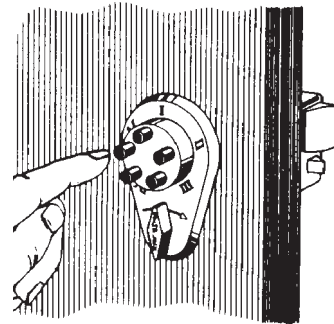

### Spring Latch Function (Night Latch)—

Locks automatically when door closes and requires correct combination to re-open from outside. Can always be opened from inside by turning lever. The thumb slide on inside housing is used to hold the deadlocking latch in a retracted position to keep the Simplex lock open, when desired. For doors that swing out, the latch bolt can be reversed.

### •Deadbolt door lock with 1" bolt—

Stock No.	Thick*	Finish
SI-9020000-04-41	1-3/8"	Satin Brass
SI-9020000-26D-41	1-3/8"	Satin Chrome
SI-9040000-04-41	1-3/4"	Satin Brass
SI-9040000-26D-41	1-3/4"	Satin Chrome

### •Above Lock With Key By-pass Cylinder—

Stock No.	Thick*	Finish
SI-9060000-04-41	1-3/8"	Satin Brass
SI-9060000-26D-41	1-3/8"	Satin Chrome
SI-9100000-04-41	1-3/4"	Satin Brass
SI-9100000-26D-41	1-3/4"	Satin Chrome

### •Spring Latch door lock with hold back—

Stock No.	Thick*	Finish
SI-9170000-04-41	1-3/8"	Satin Brass
SI-9170000-26D-41	1-3/8"	Satin Chrome
SI-9190000-04-41	1-3/4"	Satin Brass
SI-9190000-26D-41	1-3/4"	Satin Chrome

### •Above Lock With Key By-pass Cylinder—

Stock No.	Thick*	Finish
SI-9350000-04-41	1-3/8"	Satin Brass
SI-9350000-26D-41	1-3/8"	Satin Chrome
SI-9380000-04-41	1-3/4"	Satin Brass
SI-9380000-26D-41	1-3/4"	Satin Chrome

### Key By-pass Option—

Above models (deadbolt & night latch) are available with an optional key cylinder that provides the flexibility of a master key system and the security advantages of a combination lock. Employees, tenants, etc., use the pushbutton combinations. The key insures entry, regardless of the combination setting used.

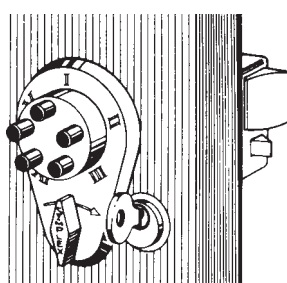

### INSIDE VIEW of Spring (Night) Latch Function

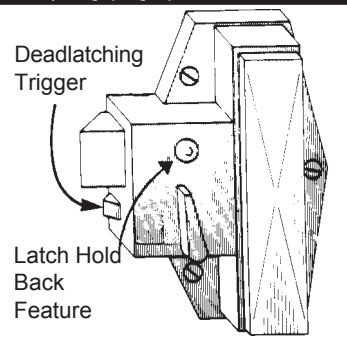

### Adapter Kit For Metal Door & Frame Installations—

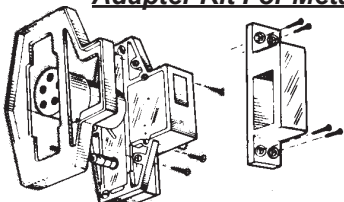

**Brass Finish** SI-800-04-41  
**Chrome Finish** SI-800-26D-41

Adapter kit containing a special surface-mounted cast strike and adjustable riser plate as shown is available. The special strike is fastened to the inside surface of the metal frame and eliminates the need to cut or mortise the frame for the standard strike. The adjustable riser plate raises the lock housing to ensure proper alignment of the latch or dead bolt with the special strike.

### For Wood Door And Frame Installation—

Just drill two holes—one 7/8" and one 1-5/8". All Simplex 900 Series Door Locks require a minimum flat surface of 3-3/4" on inside of door to mount. FOR METAL DOOR INSTALLATION, YOU SHOULD ORDER EITHER THE SI-800-04-41 OR SI-800-26D-41 ADAPTER KIT

# SIMPLEX



## SIMPLEX 6200 SERIES LIGHT COMMERCIAL/ RESIDENTIAL LOCK

- 3-hour UL.ULC fire rating for "A" label doors
- Vandal resistant, 5 button
- Retrofits 2-1/8" standard bore cylindrical locksets

### SPECIFICATIONS

**Lock Body:** Height 8-7/8" x Width 2-3/4" x Depth 2-9/16"  
**Backset:** 2-3/4"  
**Throw:** 1/2"  
**Bore:** 2-1/8"  
**Strike:** T-strike with strike box  
**Door Thick.:** 1-3/8" to 2-1/4"  
**Minimum Stile:** 5"  
**Handing:** Factory handed left, field reversible

Access by combination, while allowing free egress at all times by interior knob. The lockset automatically relocks each time the door closes. The lock can be inverted if the existing auxiliary lock obstructs installation.

**Combination Code:** One code per lock made of any combination of one to five numbers (pressed individually or simultaneously). **Number of Combinations:** Thousands of possible combinations.

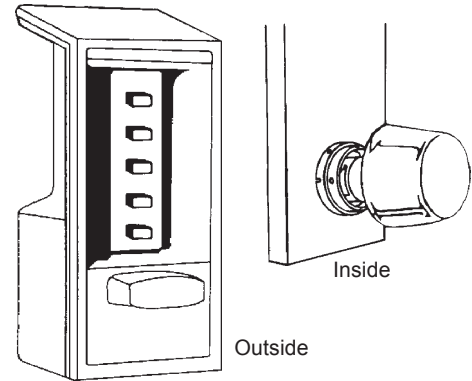

<u>Stock No.</u>	<u>Finish</u>
SI-6204-60-41	Gold Tone
SI-6204-85-41	Black
SI-6204-86-41	Grey

## SIMPLEX 7100 SERIES LIGHT COMMERCIAL/ RESIDENTIAL LOCK

- Vandal resistant, 5 button

### SPECIFICATIONS

**Lock Body:** Height 8-7/8" x Width 2-3/4" x Depth 2-9/16"  
**Backset:** varies by model number  
**Throw:** varies by model number  
**Bore:** 1-3/8" x 1" (except 7106: 3/4")  
**Strike:** **7102, 7108:** Flat strike  
**7104:** curved lip strike  
**7106:** box strike for inswing door, flat or outswing doors  
**Door Thick.:** 1-3/8" to 2-1/4"  
**Minimum Stile:** 4"  
**Handing:** Field reversible

The 7100 Series lockset provides fully mechanical primary or auxiliary push-button access control by exterior combination, while allowing free egress at all times by interior thumbturn. Deadbolt models are manually relocking. Deadlocking models automatically relock each time the door closes. 7100 Series locks mount above the existing lockset, or can be used alone.

**Combination Code:** One code per lock made of any combination of one to five numbers (pressed individually or simultaneously). **Number of Combinations:** Thousands of possible combinations.

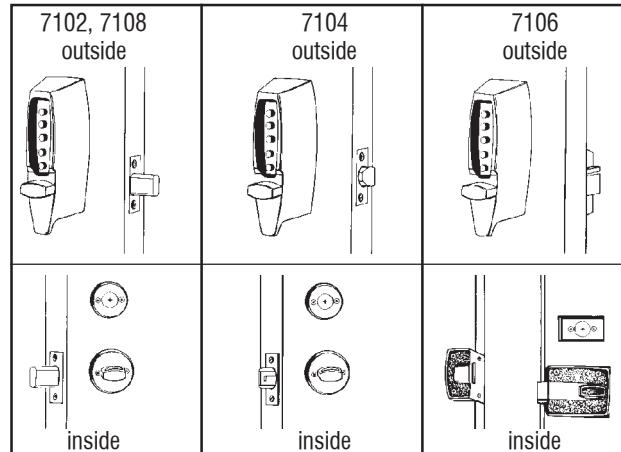

<u>Stock No.</u>	<u>Finish</u>
• 1" deadbolt, 2-3/4" backset, Manual relock.	
SI-7102-03-41	Bright Brass
SI-7102-26D-41	Satin Chrome
• 1" deadbolt, 2-3/8" backset, Manual relock.	
SI-7108-03-41	Bright Brass
• 1/2" deadlocking latch, 2-3/8" - 2-3/4", Auto relock.	
SI-7104-03-41	Bright Brass
SI-7104-26D-41	Satin Chrome
• 5/8" deadlocking latch (surface), 2-3/8" backset, Auto relock & latch holdback. For wood doors only.	
SI-7106-19-41	Black (Powder Paint)
SI-7106-26D-41	Satin Chrome

**We are your source for Simplex**

The 7000 Series is changing to the 7100 Series.

©ZIPF LOCK COMPANY

# SIMPLEX



## SIMPLEX 900 SERIES LOCK PARTS

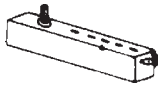

**SI-74080-000-01 (852)**  
M-55 combination chamber for all locks  
(7/8" x 15/16" x 3-7/8")

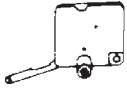

**SI-74167-1-000-01** For Deadlock  
**SI-74163-1-000-01** For Night Latch  
Gear plate assembly for key bypass models.



**SI-74471-04-01** Brass  
**SI-74471-26D-01** Chrome  
Inside operating knob assembly, including attaching hardware for all door locks.



**SI-74470-04-01** Brass  
**SI-74470-26D-01** Chrome  
Outside operating knob assembly, including attaching hardware for all door locks.



**SI-34011-04-01** Brass  
**SI-34011-26D-01** Chrome  
Latch bolt for night latch (NL) locks.

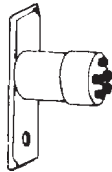

**SI-74124-1-04-01** 1-3/8" locks-Brass  
**SI-74124-1-26D-01** 1-3/8" locks-Chrome  
**SI-74125-1-04-01** 1-3/4" locks-Brass  
**SI-74125-1-26D-01** 1-3/4" locks-Chrome  
Center plate and barrel assembly with five black nylon buttons in a circle.



**SI-74468-04-01** Brass  
Riser plate for 1-3/8" lock, to shim lock housings 1/4" or 3/8".



**SI-54133-04-01** Brass (Limited Supply)  
**SI-54133-26D-01** Chrome (Limited Supply)  
Special tamper-proof combination change access screw.



**SI-805-26D-41** Chrome  
**Face Plate Shield**—Prevents observation of pushbutton operations and maintains secrecy of the combination. For use with Models DL and NL. NOT for use with key bypass models.

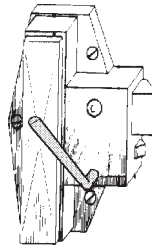

**SI-74437-26D-01** Chrome (Limited Supply)  
**Inside Lever Handle**—This accessory permits unlocking the Simplex latch model and pulling the door open with one hand. Existing locks can be converted by simply removing standard finger operated lever and installing the 2-1/2" lever handle.

## SIMPLEX 1000 SERIES LOCK PARTS



**SI-201019-000-01**  
Knob return spring for SI-1000 Series.

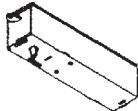

**SI-74366-000-01** (Old #201429-000-01)  
M-56/M-63 combination chamber for 1000, L1000, 3000, 8100 Series.

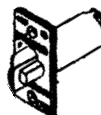

**SI-204168-26D-01** Satin Chrome  
1/2" floating front throw latch, 2-3/4" backset. For 1000 and L1000 series.

## SIMPLEX 1000 SERIES SERVICE KITS

More kits next page

**If you handle the 1000 Series Pushbutton locks then these Service Kits are a must!! These kits are packaged with all the parts usually required to recondition or refurbish these locks**

### 1000 Series Service Kit

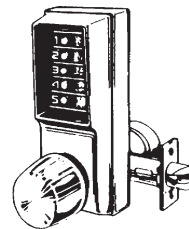

**Stock No.**  
**SI-203035-000-01**

**Includes:**

- Combination Chamber
- Clutch Assembly
- Chamber Shaft Bearing
- Stop Plate
- Knob Return Spring
- Key Override Drive Shaft
- Standard Drive Shaft
- Key Override Drive Shaft 1-3/8"
- Standard Drive Shaft 1-3/8"

# SIMPLEX



## SIMPLEX 1000 SERIES SERVICE KITS (con't)

If you handle the 1000 Series Pushbutton locks then these Service Kits are a must!! These kits are packaged with all the parts usually required to recondition or refurbish these locks

### L1000 Series Service Kit

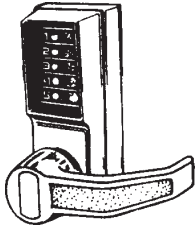

Stock No	Hand
SI-203037-000-01	Right Hand
SI-203038-000-01	Left Hand

**Includes:**  
 Combination Chamber  
 Clutch Assembly  
 Chamber Shaft Bearing  
 Stop Plate  
 Extension Spring  
 Fixed Sleeve  
 Drive Shaft (key override)  
 Drive Shaft (no key override)  
 Drive Shaft 1-3/8"(key override)  
 Drive Shaft 1-3/8" (no key override)

### LP1000 Series Service Kit

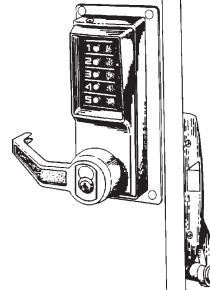

Stock No	Hand
SI-203039-000-01	Right Hand
SI-203040-000-01	Left Hand

**Includes:**  
 Combination Chamber  
 Clutch Assembly  
 Chamber Shaft Bushing  
 Stop Plate  
 Tailpiece Assembly  
 Extension Spring  
 Key Override Shaft (Best)  
 Key Override Shaft (all others)  
**Discontinued. Call for closeout prices.**

## INSTALLATION KITS By ProLok

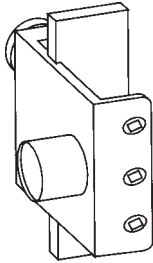

### PK-INCL Universal Clamp

The cornerstone of our Professional Installation Series. Holds all of the specialty templates without damage to the door's finish. Complete with an easy to use 1-1/2" sure-grip knob for quick and positive hand tightening. For 1-3/4" door with a 2-3/4" backset.

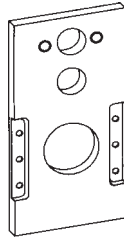

### PK-IN10 Simplex/Trilogy

Preps door for Simplex 1000 Series locks and Trilogy push button locks.

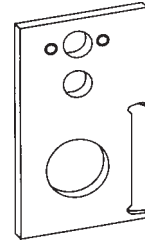

### PK-IN10R Reverse Simplex/Trilogy

Same as IN10 but preps reverse side of door.