

SECURITRON

MODEL 32 ELECTROMAGNETIC LOCKS

SECURITRON

MAGNACARE
LIFETIME REPLACEMENT WARRANTY

- Instant release circuit—no residual magnetism.
- Surface mounts easily with minimum of tools.
- Fully sealed electronics—tamper proof & weather proof.
- Mounted using steel machines screws into blind finishing nuts.
- Architectural brushed stainless steel finish (US32D/630).
- All ferrous metal surfaces plated to MIL specification.
- Ten feet (3.05m) of jacketed, stranded conductor.
- **UL Listed.**

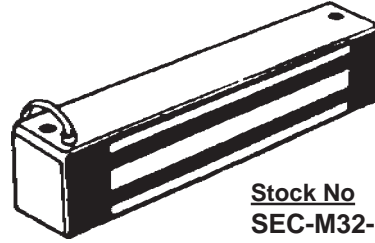

Stock No	Description
SEC-M32-12	12 volts
SEC-M32-24	24 volts

Model 32 provides 600 pounds "traffic control" security—similar to electric strikes—and is recommended for applications where physical assault on the door is not expected, like access controlled interior rooms and secure areas within buildings. Primary benefits of this model are its lower cost and more compact size. Please specify voltage in 12 or 24 VDC when ordering. **Current Draw and Voltage:** 300mA at 12VDC; or 150 mA at 24 VDC. **Dimensions:** 32 magnet—8"L x 1-7/8"W x 1-1/2"H. 32 strike—6-1/4"L x 1-5/8"W x 1/2"H.

MODEL 62 ELECTROMAGNETIC LOCKS

- Instant release circuit—no residual magnetism.
- Surface mounts easily with minimum of tools.
- Fully sealed electronics—tamper proof & weather proof.
- Mounted using steel machines screws into blind finishing nuts.
- Architectural brushed stainless steel finish (US32D/630).
- All ferrous metal surfaces plated to MIL specification.
- Ten feet (3.05m) of jacketed, stranded conductor.
- Automatic dual voltage—no field adjustment required.
- **UL Listed.**

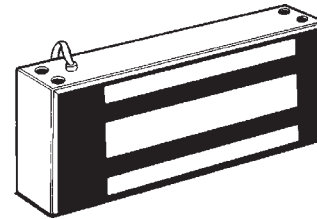

MAGNACARE
LIFETIME REPLACEMENT WARRANTY



Stock No	Description
SEC-M62	Standard Model 12/24VDC
SEC-M62F*	Face Mount Model 12/24VDC

Model 62 increasing holding power to 1200 pounds, appropriate for exterior and perimeter doors through which criminals could gain entrance to cause substantial economic loss. Entry cannot be forced without special tools, or before the door and frame actually give way. Model 62 is also available with the "G" option (special order), which adds a universal conduit for fitting for outdoor installations or surface-wired installations on concrete filled door frames. **Current Draw and Voltage:** 250mA at 12VDC; or 125 mA at 24 VDC. **Dimensions:** 62 magnet—8"L x 1-3/4"W x 3"H. 62 strike—6"L x 1-1/2"W x 2-3/4"H.

*For doors that swing into the protected area security considerations may dictate the lock mounts on the in-swinging side of the door. The "F" option provides for face mounting on the header above the door. Mounting holes are drilled through the magnet face, and wire exits the rear. The SEC-Z-62 is normally used with "F" Magnalocks.

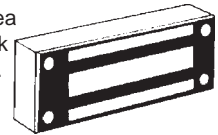

SENSTAT—(Special Order) The lock monitors itself!! The Senstat option provides a lock status sensing signal which positively indicates that the door is secure. This interfaces with access control or alarm systems and is superior to the commonly used door position switch which indicates that the door is closed but not that it is secure. All Senstat Magnalocks use Form "C" isolated contacts.

OTHER OPTIONS ARE AVAILABLE BY SPECIAL ORDER

MAGNACARE
LIFETIME REPLACEMENT WARRANTY

Features: *Lifetime*—the warranty does NOT expire; *No Fault*—The product will be replaced by Securitron forever for any reason, including but not limited to installation error, vandalism or act of God. *Tomorrow*—Replacement product is shipped next day air at Securitron's expense if needed.

Benefits: Magnacare covers all products Securitron manufacturers. No product registration is required, if you have the product you have the warranty.

See page 216 for full terms and conditions of MagnaCare.

©ZIPF LOCK COMPANY

SECURITRON

MAGNALOCK ACCESSORIES



Limited Supply



Stock No. **Description** **Discontinued. Call for closeout prices.**

SEC-SFP- Stop Filler Plate
Specify Thickness: 1/4, 3/8, 1/2 or 5/8

Used in installations where only part of the magnet body is on the stop. The plate extends the stop to provide a flat mount surface for the magnet. Plates are 8"L x 1-1/4"W.

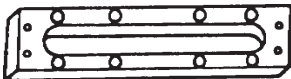

Stock No. **Description**
SEC-CWB-32-BK For Model 32
SEC-CWB-62-BK For Model 62

The Concrete/Wood Frame Bracket is used on concrete filled or wood door frames. On concrete fill frames the bracket anchors to the frame using sheet metal screws; the magnet mounts to the bracket with machine screws. The bracket includes a central splice area, avoiding the need to drill a wireway through the concrete. On wood frames, 4" wood screws penetrate into the header.

Discontinued. Call for closeout prices.

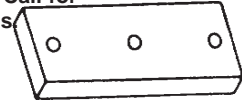

Limited Supply

Stock No. **Description**

SEC-GDB Glass Door Bracket
The glass door bracket permits Magnalock installation on a solid glass door. The bracket is permanently bonded to the glass with a special adhesive (special order). The strike plate then screws into the bracket, as glass doors cannot be drilled.

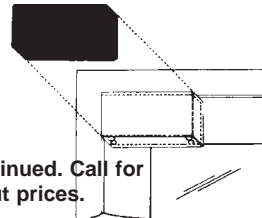

Discontinued. Call for closeout prices.

Stock No. **Finish**
SEC-DC-62BK Black

Dress cover for M62 Magnalock installs in seconds using structural form adhesive. The cover improves the appearance of the installation by concealing the lock.

INSTALLATION KIT FOR MAGNALOCKS

Special Order

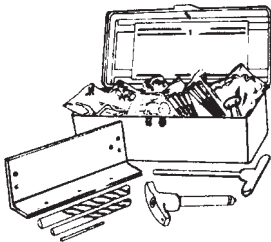

SEC-IK

Stock No. **Description**
SEC-IK Installation Kit

The official factory installation kit makes any installation quicker and more accurate. It even includes an educational, step-by-step system installation video! Here is what is included: Heavy duty drill guide, Blind nut placement tool, Handle socket driver, SB-1 sex bolt, Model 62.82 hardware pack, Model 32 hardware pack, SAM hardware pack w/brackets (on request), Rubber washers, Flat washer, insulated crimp connector, thread lock, 1/8" cobalt, 3/8" cobalt drill bit, 3/8" carbide drill bit, 1/2" high speed drill bit, socket cap screws, wood screws, blind nuts, lock nuts, finish caps, installation video.

TOUCH SENSE

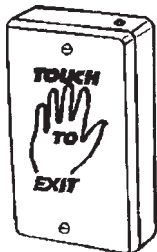

Stock No. **Description**
SEC-SP-1 Touch Sense Plate

The SEC-SP-1 uses touch sensing technology to create a push panel with no moving parts. For indoor use only, the unit is oversized so that it can be mounted over a single gang cutout. A three part vinyl decal is included to provide the appropriate prompt to the user and a red LED is incorporated in the backbox. For ADA compliant systems, an optional decal (special order) with handicap symbol is available (SP-1LH).
12 or 24 VAC or VDC, 40 mA at rest 25 mA releasing, 5-3/4" x 3-3/16" x 1-1/2", DPST 2 amp rated relay, internal timer, built in redundant button, internal 25 second timer.

©ZIPF LOCK COMPANY



213 v1
(PL-12)

SECURITRON

EXIT BUTTONS

Discontinued.
Call for close-out prices.

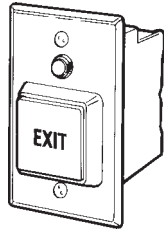

Stock No
SEC-PB2

Push Button 2" Square Mom.
Single Gang Illuminated

SECURITRON

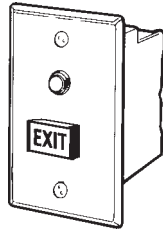

Stock No
SEC-PB3

Push Button 3/4" Rectangle
Mom. Single Gang Illumi-
nated

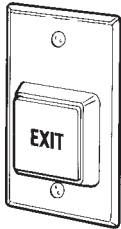

Stock No
SEC-PB2E

Push Button 2" Square Mom.
Single Gang

	PB2	PB2E	PB3
Single Gang	Yes	Yes	Yes
Single Gang Plate Measurement	2-3/4" x 4-1/2"	2-3/4" x 4-1/2"	2-3/4" x 4-1/2"
Narrow Style	No	No	Special Order
Back Box Depth	2-3/4"	2-3/4"	2-3/4"
Button Measurement	2" x 2"	2" x 2"	1" x 3/4"
Surface Mounted	No	No	Special Order
SPDT Contacts	Yes	Yes	No
DPST Contacts	No	No	Yes
DPDT Contacts	No	No	Field Modify
Contact Rating	10 amps	10 amps	3 amps
Momentary	Yes	Yes	Yes
Alternate	No	No	Special Order
Non-Illuminated Version	No	Yes	Special Order
Outdoor Use	No	No	No

MORTISE KEYSWITCH

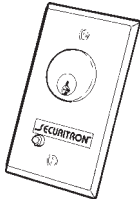

Stock No.
SEC-MK

Finish
Aluminum

The MK is an inexpensive, compatible method of allowing authorized personnel to control or signal from various locations within a facility.

Comes standard with 12/24 VDC bi-color LED and a 5 amp rated SPDT plunger switch. The backing bracket permits integration with any brand 1-1/4" or 1-1/8" mortise cylinder (NOT INCLUDED). Plate and depth dimensions are 2-3/4" x 4-1/2" x 3". Momentarily turning key changes start of the contacts, and an additional switch position on backing bracket allows another switch to be activated by turning the key in the opposite direction. **UL Listed.**

Need a mortise cylinder??

TIMEMATE SERIES

Discontinued. Call for closeout prices.



Stock No **Description**
SEC-TM-8 TimeMate

The TimeMate is an ultraminiature (3/4" x 1" x 2") timer that functions to extend momentary switch closures (Normally Open) up to 36 seconds. Commonly used in outlet boxes with keyswitches or push button controls solving the problem of "where to put the timer". The TimeMate either fits in the box or can be mounted on the exterior with supplied double stick tape. When the switch is operated, the TimeMate's 3 Amp SPDT relay energizes for 2 to 36 seconds after which it resets.

The time setting is precisely selected by a bank of dipswitches rather than by pot. Common applications include releasing electric locks and shunting alarm points. The TimeMate operates on 12 VDC, 24 VDC or 24 VAC power.

©ZIPF LOCK COMPANY

SECURITRON

POWER SUPPLIES

- 1 output circuit breaker
- LEDs monitor zoc status (voltage, no voltage)
- Internal capability of charging optional 12 or 24 VDC sealed lead acid backup batteries while operating the DC load.
- Complete!! Requires only 120VAC to the fused input.
- Rugged steel enclosure.
- Provided with emergency release terminals, allowing release of all devices upon fire alarm activation.
- Fire alarm interface.
- **UL class 2 listed.**

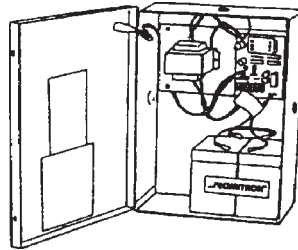

*Shown with batteries.
Must special order.*

<u>Stock No</u>	<u>Description</u>
SEC-BPS-12-1	12 VDC, 1 amp version power supply
SEC-BPS-24-1	24 VDC, 1 amp version power supply

For applications where there is interface with a fire alarm, or battery backup is needed, Securatron offers a full line of BPS power supplies. Capacity: 1A, Outputs: 1, Cabinet Size: 12" x 9" x 4".

TRANSFORMERS

<u>Stock</u>	<u>Description</u>
SEC-PSP-12	12V Transformer
SEC-PSP-24	24V Transformer



Securatron offers these hard-to-find DC units in two versions: 12 volts@700mA maximum capacity (model PSP-12) and 24 volts@350mA maximum capacity (model PSP-24). They feature an internal thermal fuse and are UL and CSA listed. A 16 ft. output cable is included. They are ideal for powering a wide range of DC devices. Dimensions: 2-1/4" x 2-1/4" x 2-1/2"

BATTERIES (Factory Order)

<u>Stock</u>	<u>Description</u>
SEC-B-12-4	12VDC 4 amp hour
SEC-B-24-4	24VDC 4 amp hour



The B12-4 12 volt 4 amp hour and B24-4 24 volt 4 amp battery packs perfectly compliment the BPS series power supply for those applications where the doors must not open in the event of a power failure. For best system performance, add the PSM series power supply monitor (special order) that systematically tests battery pack and power supply system integrity. Dimensions: 3-1/2" x 2-3/4" x 4".

DIGITAL ENTRY KEYPAD

- Stainless steel backplate with 12 keys (10 digits plus "*" and "#" keys).
- One piece digital keypad specifically designed for control of electric locks.
- Single gang, stainless steel plate with plastic backbox.
- Includes 4 user code capability which is programmable from the keypad.
- 5 Amp SPDT timed, control relay output.
- Two LEDs are furnished.
- Both LEDs also provide programming prompt.
- Red and Green LEDs are visible indicators.

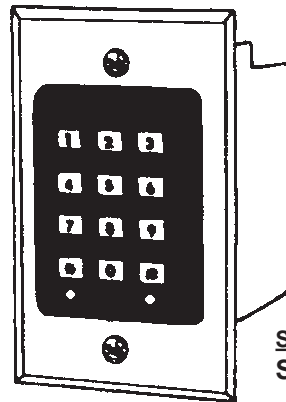

<u>Stock</u>	<u>Description</u>
SEC-DK-11	Digital Keypad

The DK-11 is a one piece unit intended for lower security requirements. It is furnished on a single gang brushed stainless steel plate with retrofit backbox. The keypad provides true 10 digit operation and includes red and green signaling LEDs. The unit runs on 12 or 24 VDC power and control output is via an integral 5 Amp SPDT relay for operating fail safe and fail secure locks. All wiring is to a terminal strip found on the CPU board directly behind the plate. While primarily intended for indoor operation, an optional rain cover (WCC, special order) allows reliable use for exterior areas not exposed to direct rain. The pad itself is a U.S. made high-volume unit with engraved, paint-filled keys. **Current Draw and Voltage:** 70 mA at 12 or 24 VDC, **Dimensions:** 4-1/2" x 2-3/4" x 3", **Operating Environment & Temperature:** Indoor use. Outdoor weather cover by special order. +32 F to +158 F.

Need an access control product not shown?? Give us a call today.

©ZIPF LOCK COMPANY



215
(PL-12)

SIMPLEX

E-PLEX E5000 SERIES ELECTRONIC ACCESS CONTROL

- ANSI/BHMA A156.2, Grade 1 Certified.
- 3-hour UL/ULC Fire rating for "A" label doors.
- Meets A.D.A. accessibility standard.
- Both housings are weather resistant.
- Four bolt installation - **no wiring**.
- Non handed - field reversible.
- **3-year warranty. Built-in warranty counter.**

E-PLEX®



SPECIFICATIONS

Backset: 2-3/4"
Throw: 1/2"
Strike: ASA and standard strike included
Door Thick.: 1-3/8" to 2-1/4"
Minimum Stile: 5"
Finishes: 26D Satin Chrome

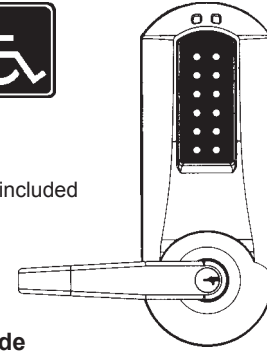

Height:
8-7/8"
Width:
3-3/8"

Stock No.

SI-E5031XK-WL-626

Key Override

Key-in-Lever Kaba 90 Keyway

The E-Plex 5000 Series combines the strength, simplicity and reliability of Simplex® mechanical push-button locks with the added security and features of electronic access control - it's never been easier to Power Up your access control. Controls access with up to 100 access codes. Exterior access is by combination or key override, and egress is by interior lever and is free at all times.

Applications: Ideal for controlling access to security sensitive areas in commercial, industrial, educational, governmental, healthcare, lodging, and multi-unit residential settings. It's perfect for restricted areas with a high user turnover rate.

Keyless convenience: Eliminates problems and costs associated with issuing, controlling, and collecting keys and magnetic cards.

Flexible operational modes: Combination (PIN) entry, Passage (programmable), Lockout.

Easy to manage: User access programmed at the lock or managed with **optional** Microsoft Excel™ based software. Users quickly added and deleted. Optional software provides increased control as facility's users and access points increase. Five authority levels allow you to control user's access to various lock functions: Master, Manager, User, Service and Maintenance. Service level has authority to gain access once, or programmed for 1 to 24 hours - for service personnel, meeting rooms, and rental space.

Extensive audit trail for added security: Lock records last 3,000 events for user accountability. Audit includes mechanical key override use.

Flexible user preferences: Adjustable anti-tamper lockout disables lock after 3 to 9 invalid entry attempts for up to 90 seconds. Adjustable relock time after combination entry from 2 to 20 seconds. Variable length access codes set from 4 to 8 digits.

Additional Specifications: (4) four AA Alkaline batteries-located in interior housing; Battery life up to 180,000 cycles; Lock data is retained if batteries fail; audible and visual indicators; low battery visual indicator.

SIMPLEX 2015 SERIES EXIT DEVICE CONTROL

- Highly weather resistant.
- Vandal resistant, 5 button
- 1-year warranty.

SPECIFICATIONS

Lock Body: Height 8-5/8" x Width 3-1/8" x Depth 2-3/4"
Tailpiece: 2-3/4" tailpiece for exit device operation from outside
Door Thick.: 1-3/8" to 2-1/2"
Handing: For non-handed or clockwise-rotating exit device hubs only (adjustable up to 90°)
Minimum Stile: 5"
Finishes: 26D Satin Chrome



6-pin tumbler cylinder keys for combination change access. Keyed Different.

Exit device & handle not included. Order separately.

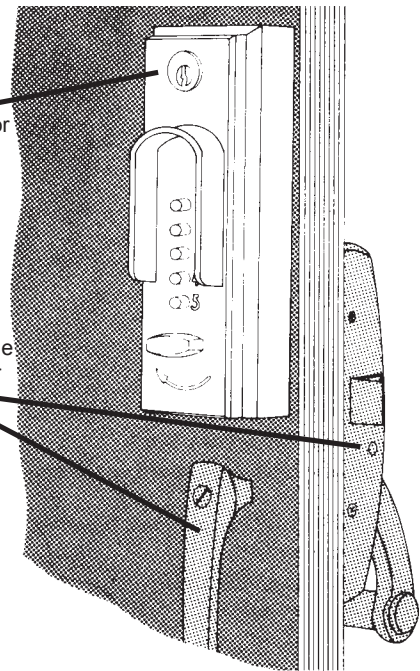

Stock No.

SI-2015-26D-41

Finish

Satin Chrome

EXIT DEVICE COMPATIBILITY:

Von Duprin: 22, 22F, 88, 88F, 98, 98F, 99, 99F RIMS; 2227, 2227F, 9827, 9827F, 9847, 9847F, 9927F, 9947F.

American Device: 6300, 6303.

Detex Advantex Series: 10, 20, 21, 40, 50, 51.

Monarch: 18RBA, 18RP, 18VP, F18RBA, F18RP, F18VP, FXXRBA, FXXRP, FXXVP, XXRBA, XXRP, XXVP

Yale: 1500, 7000.

Corbin: 21, 22, 25, 26NT, 27K, 29, 29-1/4, 29M2, 29-1/2M2, 29NTM2, 29D20, LA29, 39, 39EL, 39LLD, 390, LA39.

Russwin: 365, 3651/4, LT365, 370, 372, LA372, 375, LT375, 377, 382, 384, 385, 388, 572, 572EL, 572ELD, U572, LA572.

Sargent: 2813, 2804, 6804, 12-6804, 9804RHRB, 12-9804LHRB, 9898E, 9898K.

©ZIPF LOCK COMPANY

SIMPLEX

Application—Model LP1000 and 2015(next page) exit device controls are designed to operate surface mount (rim-mounted) exit devices from the outside using a tailpiece, which replaces the key cylinder on new or existing devices. Any standard pull can be mounted with model 2015. They provide exterior access by combination, while allowing free egress at all times by interior exit device. The locks can be used with many leading brands of surface-mounted (rim-mounted) exit devices.

SIMPLEX LP1000 SERIES EXIT DEVICE OPERATOR

- Conforms with ANSI A156.2, Grade 1.
- 3-hour UL/ULC Fire rating for "A" label doors.
- Highly weather resistant.
- Vandal resistant, 5 button
- **3-year warranty.**

SPECIFICATIONS

Lock Body: Height 8-3/4" x Width 4-3/8" x Depth 3-7/8"
Tailpiece: 2-3/4" tailpiece for exit device operation from outside
Door Thick.: 1-3/8" to 2-1/4"
Handing: Handed, not reversible
Minimum Stile: 5"
Finishes: 26D Satin Chrome

EXIT DEVICE COMPATIBILITY:

Von Duprin: Exit Only (EO) or Exit Only Fire (EOF) 22, 88 NL, 98, 99, 9857, 9957.
Detex Advantex Series: 10, 20, 21, 40, 50, 51.
Dorma: 9100, 9300, 9400.
Monarch: XXR*, FXXR*, 18R*, F18R*, XXV*, FXXV*, 18V*, F18V*.
 (*Requires special K adapter)
 Can not be used with mortise design or most vertical rod exit device.

**Need a core or exit device??
Just let us know.**

LP1000 Series can not be used with mortise design and most vertical rod exit devices.

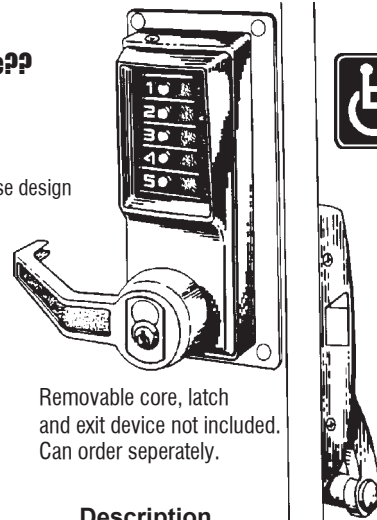

Removable core, latch and exit device not included. Can order seperately.

Stock No.

SI-LLP1020B-26D-41
SI-LRP1020B-26D-41
SI-LLP1020S-26D-41
SI-LRP1020S-26D-41

Description

Left Hand, For Best type core
 Right Hand, For Best type core
 Left Hand, For Schlage full size core
 Right Hand, For Schlage full size core

Application—Model 3000 series locks provide fully mechanical pushbutton access control for narrow stile aluminum glass doors. It provides exterior access by combination or key override, while allowing free egress at all times.

Model 3000 series is designed for use with Adams Rite 4510/4710 latch mechanisms and most Adams Rite egress hardware (order separately). Any standard MS mortise cylinder that operates the Adams Rite latch will function with the 3000 series lock. Suitable for inswing and outswing doors.

SIMPLEX 3000 SERIES NARROW STILE LOCKS



- Highly weather resistant.
- Vandal resistant, 5 button
- 1-year warranty.

SPECIFICATIONS

Lock Body: Height 9-5/8" x Width 1-17/32" x Depth 2-5/8"
Backset: 3010, 3020 31/32"; 3030, 3040 1-1/8"
Stile Width: 1-7/8" minimum required for mounting
Door Thick.: 1-3/4" maximum

Features:

Key override can be used to override the lock combination and gain access using a key. This feature allows facilities to initiate or maintain a master-keyed security system. The lock accepts MS (maximum security) mortise cylinders.

Passage (latch holdback) allows access without using the lock entry code, keeping the door unlocked. This feature is activated from the outside with a key.

Lockout disables the lock so that entry codes cannot be used to gain access. Access is permitted using the key override only. This feature is activated from the outside using the override key.

LATCH NOT INCLUDED
Order separately.

CYLINDER NOT INCLUDED
Order separately.

You must order housing and drive assembly for complete lock

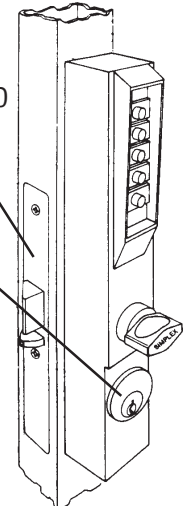

Housing—

Stock No.

SI-3001-26D-41
SI-3001-55-41

Finish

Satin Chrome
 Duranodic

Drive Assembly—

Stock No.

SI-3010-19-41
SI-3020-19-41
SI-3030-19-41
SI-3040-19-41

Backset and Handing

31/32" backset RH or RHRB
 31/32" backset LH or LHRB
 1-1/8" backset RH or RHRB
 1-1/8" backset LH or LHRB

SIMPLEX

SIMPLEX 900 SERIES LIGHT COMMERCIAL/ RESIDENTIAL LOCK



Deadbolt Function—

To open from outside, press combination and turn front knob to open. The lock remains open (bolt retracted) until either the inside lever or outside knob is turned to throw bolt into locked position.

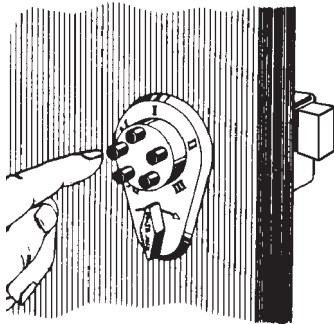

SPECIFICATIONS

Backset: Outswing door: 2-9/16"
Inswing door: 2-1/2"
Latch: On Deadbolt lock 1"
Keypad: Vandal resistant, 5 button.
Handing: Field reversible latch. Invert lock for right hand door.
Bore: 1-5/8" for barrel, 3/4" for thumbturn, 7/8" for key override

***Door Thickness:**
1-3/8" for 1-3/8" to 1-1/2" thick doors
1-3/4" for 1-3/4" to 2-1/8" thick doors

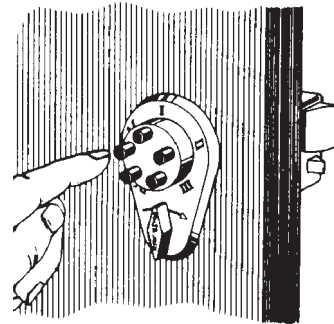

Spring Latch Function (Night Latch)—

Locks automatically when door closes and requires correct combination to re-open from outside. Can always be opened from inside by turning lever. The thumb slide on inside housing is used to hold the deadlocking latch in a retracted position to keep the Simplex lock open, when desired. For doors that swing out, the latch bolt can be reversed.

•Deadbolt door lock with 1" bolt—

Stock No.	Thick*	Finish
SI-9020000-04-41	1-3/8"	Satin Brass
SI-9020000-26D-41	1-3/8"	Satin Chrome
SI-9040000-04-41	1-3/4"	Satin Brass
SI-9040000-26D-41	1-3/4"	Satin Chrome

•Above Lock With Key By-pass Cylinder—

Stock No.	Thick*	Finish
SI-9060000-04-41	1-3/8"	Satin Brass
SI-9060000-26D-41	1-3/8"	Satin Chrome
SI-9100000-04-41	1-3/4"	Satin Brass
SI-9100000-26D-41	1-3/4"	Satin Chrome

•Spring Latch door lock with hold back—

Stock No.	Thick*	Finish
SI-9170000-04-41	1-3/8"	Satin Brass
SI-9170000-26D-41	1-3/8"	Satin Chrome
SI-9190000-04-41	1-3/4"	Satin Brass
SI-9190000-26D-41	1-3/4"	Satin Chrome

•Above Lock With Key By-pass Cylinder—

Stock No.	Thick*	Finish
SI-9350000-04-41	1-3/8"	Satin Brass
SI-9350000-26D-41	1-3/8"	Satin Chrome
SI-9380000-04-41	1-3/4"	Satin Brass
SI-9380000-26D-41	1-3/4"	Satin Chrome

Key By-pass Option—

Above models (deadbolt & night latch) are available with an optional key cylinder that provides the flexibility of a master key system and the security advantages of a combination lock. Employees, tenants, etc., use the pushbutton combinations. The key insures entry, regardless of the combination setting used.

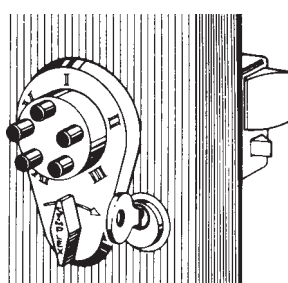

INSIDE VIEW of Spring (Night) Latch Function

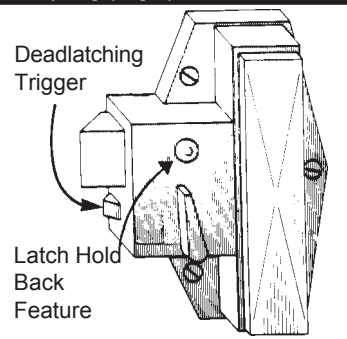

Adapter Kit For Metal Door & Frame Installations—

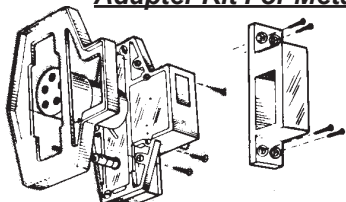

Brass Finish SI-800-04-41
Chrome Finish SI-800-26D-41

Adapter kit containing a special surface-mounted cast strike and adjustable riser plate as shown is available. The special strike is fastened to the inside surface of the metal frame and eliminates the need to cut or mortise the frame for the standard strike. The adjustable riser plate raises the lock housing to ensure proper alignment of the latch or dead bolt with the special strike.

For Wood Door And Frame Installation—

Just drill two holes—one 7/8" and one 1-5/8". All Simplex 900 Series Door Locks require a minimum flat surface of 3-3/4" on inside of door to mount. FOR METAL DOOR INSTALLATION, YOU SHOULD ORDER EITHER THE SI-800-04-41 OR SI-800-26D-41 ADAPTER KIT

SIMPLEX



SIMPLEX 6200 SERIES LIGHT COMMERCIAL/ RESIDENTIAL LOCK

- 3-hour UL.ULC fire rating for "A" label doors
- Vandal resistant, 5 button
- Retrofits 2-1/8" standard bore cylindrical locksets

SPECIFICATIONS

Lock Body: Height 8-7/8" x Width 2-3/4" x Depth 2-9/16"
Backset: 2-3/4"
Throw: 1/2"
Bore: 2-1/8"
Strike: T-strike with strike box
Door Thick.: 1-3/8" to 2-1/4"
Minimum Stile: 5"
Handing: Factory handed left, field reversible

Access by combination, while allowing free egress at all times by interior knob. The lockset automatically relocks each time the door closes. The lock can be inverted if the existing auxiliary lock obstructs installation.

Combination Code: One code per lock made of any combination of one to five numbers (pressed individually or simultaneously). **Number of Combinations:** Thousands of possible combinations.

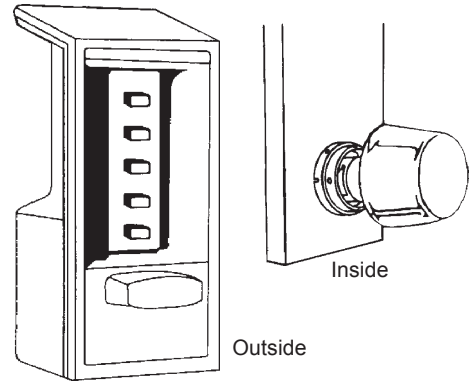

<u>Stock No.</u>	<u>Finish</u>
SI-6204-60-41	Gold Tone
SI-6204-85-41	Black
SI-6204-86-41	Grey

SIMPLEX 7100 SERIES LIGHT COMMERCIAL/ RESIDENTIAL LOCK

- Vandal resistant, 5 button

SPECIFICATIONS

Lock Body: Height 8-7/8" x Width 2-3/4" x Depth 2-9/16"
Backset: varies by model number
Throw: varies by model number
Bore: 1-3/8" x 1" (except 7106: 3/4")
Strike: **7102, 7108:** Flat strike
7104: curved lip strike
7106: box strike for inswing door, flat or outswing doors
Door Thick.: 1-3/8" to 2-1/4"
Minimum Stile: 4"
Handing: Field reversible

The 7100 Series lockset provides fully mechanical primary or auxiliary push-button access control by exterior combination, while allowing free egress at all times by interior thumbturn. Deadbolt models are manually relocking. Deadlocking models automatically relock each time the door closes. 7100 Series locks mount above the existing lockset, or can be used alone.

Combination Code: One code per lock made of any combination of one to five numbers (pressed individually or simultaneously). **Number of Combinations:** Thousands of possible combinations.

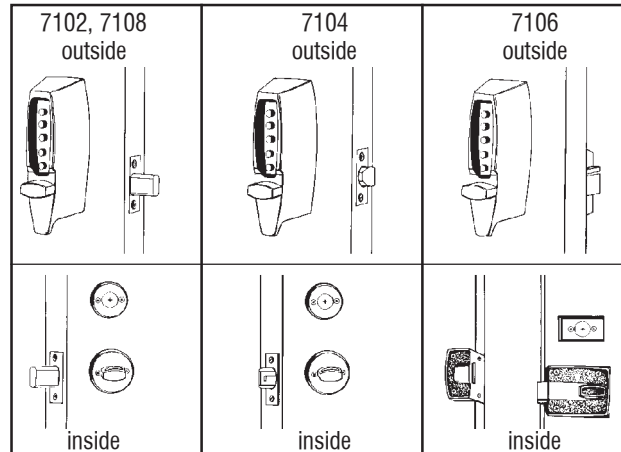

<u>Stock No.</u>	<u>Finish</u>
• 1" deadbolt, 2-3/4" backset, Manual relock.	
SI-7102-03-41	Bright Brass
SI-7102-26D-41	Satin Chrome
• 1" deadbolt, 2-3/8" backset, Manual relock.	
SI-7108-03-41	Bright Brass
• 1/2" deadlocking latch, 2-3/8" - 2-3/4", Auto relock.	
SI-7104-03-41	Bright Brass
SI-7104-26D-41	Satin Chrome
• 5/8" deadlocking latch (surface), 2-3/8" backset, Auto relock & latch holdback. For wood doors only.	
SI-7106-19-41	Black (Powder Paint)
SI-7106-26D-41	Satin Chrome

We are your source for Simplex

The 7000 Series is changing to the 7100 Series.

©ZIPF LOCK COMPANY