

SCHLAGE

A SERIES



20 locks per case

For Heavy Duty Residential and Medium Duty Commercial

- ANSI A156.2, 1996, Series 4000, Grade 2.
- UL Listed for 3-hour Fire Door.
- 3-year Mechanical Warranty.

COMMERCIAL APPLICATIONS
CONTRACTOR

See page 180 for Orbit CSV.

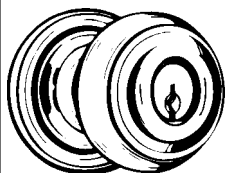

GEORGIAN (GEO)
605, 609
(NS: 606, 610, 625, 626)

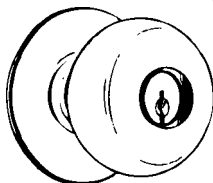

PLYMOUTH (PLY)
605, 612, 613, 626
(NS: 606, 609, 610, 611, 616, 625, 629, 630)

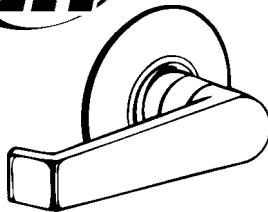

LEVON (LEV)
605, 613, 626
Keyed Locks have ORB knob outside.
(NS: 612)

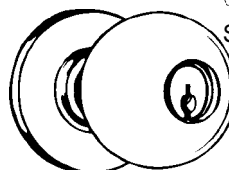

ORBIT (ORB)
605, 612, 613, 625, 626
Also stock JD in 626
(NS: 606, 609, 610, 611, 616)

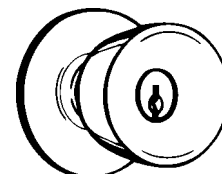

TULIP (TUL)
605, 626
(NS: 606, 609, 610, 625)

(NS) Non-stock finish available as factory special order. Some finishes may have factory special handling charge.

606-Satin Brass; 610-Bright Brass, Blackened, Bright Relieved; 611-Bright Bronze; 616-Antique Bronze, Satin Bronze, Blackened, Satin Relieved; 629-Bright Stainless Steel; 630-Satin Stainless Steel.

To Order, Specify:

Function: **A53PD** Entrance
Design: **PLY** Plymouth
Finish: **605** Bright Brass
*Latch: **234** 2-3/4" Backset

*Please specify latch. Selection may be limited.

Unless otherwise specified, 2-3/8" square face latch is standard. Specify **DI** for drive-in latch.

Specify if 1" wide latch is required for 2-3/4" backset.

Not all functions are available in all designs/finishes

Cylinder Options (Limited Selection-Please Call)

Just replace "PD" with...

LD- Less 6-Pin Cylinder.

JD- Less Full Size Interchangeable

Core. Pictured at right. (ORB 626)

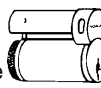

23-030-C

23-030-C123

23-030-C145

23-030-E

SPECIFICATIONS

DOOR THICKNESS: 1-3/8" to 1-7/8"
BACKSET: 2-3/8", 2-3/4"
BORE: 2-1/8" x 7/8" (1" with latch collar)
ROSE: 2-9/16"
KEY BLANKS: 35-100- 5 pin
35-101- 6 pin

KEYWAYS: **PD-C** Standard, 6-pin, keyed to 5 pin
E, F Optional in most cases. **EVEREST-**
C123 or C145 also available.
LD- Less Cylinder-limited selection.
JD- Less Full Size Interchangeable Core-
limited selection (ORB 626).

FINISHES: **605**(US-3) Bright Brass, clear coated
609(US-5) Antique Brass, clear coated
612(US-10) Satin Bronze, clear coated
613(US-10B) Oil Rubbed Bronze
625(US-26) Bright Chrome
626(US-26D) Satin Chrome

Function	No.	Operation	ANSI
PASSAGE	A10S	Both knobs/levers always unlocked.	F75
EXIT	A25D	Blank plate outside. Inside knob always unlocked. FOR 1-3/4" THICK DOOR ONLY.	
BATH/BEDROOM PRIVACY	A40S	Push-button locking. Can be unlocked from outside with small screwdriver. Turning inside knob/lever or closing door releases button.	F76
ENTRANCE	A53PD	Turn/Push-button locking: pushing and turning button locks outside knob, requiring use of key until button is manually unlocked. Push-button locking: pushing button locks outside knob until unlocked by key or by turning inside knob/lever. (1 cylinder)	F109
CLASSROOM	A70PD	Outside knob locked and unlocked by key. Inside knob always unlocked. (1 cylinder)	F84
COMMUNICATING	A79PD	Locked or unlocked by key from outside. Blank plate inside. (1 cylinder)	
STOREROOM	A80PD	Outside knob fixed. Entrance by key only. Inside knob always unlocked. (1 cylinder)	F86
HOTEL/MOTEL	A85PD	Outside knob fixed. Entrance by key only. Push-button in inside knob activates visual occupancy indicator, allowing only emergency master key to operate. Turning inside knob or closing door release visual occupancy indicator. Rotation of inside spanner-button provides lockout feature by keeping indicator activated. (1 cylinder)	F93
SINGLE DUMMY	A170	Dummy trim for one side of door. Used for door pull or as matching inactive trim.	

©ZIPF LOCK COMPANY

SCHLAGE

AL SERIES

For Standard Duty Commercial

- ANSI A156.2-1996 Series 4000, Grade 2.
- U.L. Listed for 3-hour Fire Doors.
- 3-Year Mechanical Warranty. (Exclusion: Key-in-lever used on educational facilities)
- Non-Handed.
- Heavy Duty Compression Springs.
- Stainless Steel Interlocking Spindle.
- Levers BOTH Sides.

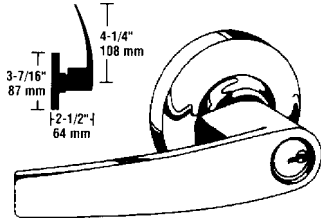

**JUPITER
(JUP)**

605, 613, 626
(NS: 606, 612, 619, 625)

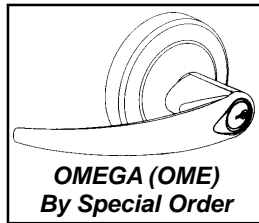

OMEGA (OME)
By Special Order

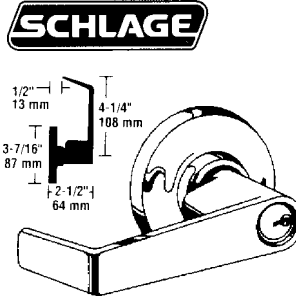

**SATURN
(SAT)**

605, 609, 612, 613, 619, 625, 626

(NS: 606)

Also stock BD, JD in 626



6 locks per case

Complies
with A.D.A.
requirements

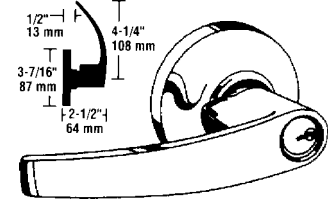

**NEPTUNE
(NEP)**

605, 613, 619, 626

(NS: 606, 609, 612, 625)

SPECIFICATIONS

DOOR THICKNESS: 1-3/8" to 1-7/8"

BACKSET: 2-3/4" sq. corner 1-1/8" wide face

STRIKE: 10-025

BORE: 2-1/8" x 1"

THROUGHBOLTS: 5/16" diam. 2-3/4" center to center.

ROSE: 3-7/16"

KEY BLANKS: 35-100- 5 pin

35-101- 6 pin

KEYWAYS: PD-C Standard, 6-pin, keyed to 5 pin
E, F Optional in most cases. EVEREST-
C123 or C145 also available.

LD-Less Cylinder-limited selection.

JD-Less Full Size Interchangeable Core-
limited selection.

BD-Less SFIC- limited selection in SAT.

605(US-3) Bright Brass, clear coated

609(US-5) Antique Brass, clear coated

612(US-10) Satin Bronze, clear coated

613(US-10B) Oil Rubbed Bronze

619(US-15) Satin Nickel

625(US-26) Bright Chrome

626(US-26D) Satin Chrome

FINISHES:

To Order, Specify:

Function: **AL53PD** Entrance

Design: **SAT** Saturn

Finish: **605** Bright Brass

Latch: **234** 2-3/4" Backset

Not all functions are available in all designs/finishes

Cylinder Options (Limited Selection-Please Call)

Just replace "PD" with...

LD- Less 6-Pin Cylinder.

JD- Less Full Size Interchangeable

Core. Pictured at right. (SAT 626)

BD-Less SFIC-Small Format I/C (SAT 626, 613 in AL53)



Function	No.	Operation	ANSI
PASSAGE	AL10S	Both levers always unlocked.	F75
BED/BEDROOM PRIVACY	AL40S	Push-button locking. Can be unlocked from outside with small screwdriver. Turning inside lever or closing door releases button.	F76
ENTRANCE/ OFFICE	AL50PD	Push-button locking: pushing button locks outside lever until unlocked by key or by turning inside lever. (1 cylinder)	F82
ENTRANCE	AL53PD	Turn/Push button locking: pushing and turning button locks outside lever requiring use of key until button is manually unlocked. Push-button locking: pushing button locks outside lever until unlocked by key or by turning inside lever. (1 cylinder)	F109
CLASSROOM	AL70PD	Outside lever locked and unlocked by key. Inside lever always unlocked. (1 cylinder)	F84
STOREROOM	AL80PD	Outside lever fixed. Entrance by key only. Inside lever always unlocked. (1 cylinder)	F86
SINGLE DUMMY	AL170	Single dummy trim for one side of door. Used for door pull or as matching inactive trim.	

(NS) Non-stock finish available as factory special order. Some finishes may have factory special handling charge.

606-Satin Brass, clear coated; 610-Bright Brass, Blackened, Bright Relieved; 611-Bright Bronze; 616-Antique Bronze, Satin Bronze, Blackened, Satin Relieved;

629-Bright Stainless Steel; 630-Satin Stainless Steel.

©ZIPF LOCK COMPANY

SCHLAGE

D SERIES KNOBS ND SERIES LEVERS

For Heavy Duty Commercial

- ANSI A156.2, 1996, Series 4000, Grade 1.
- 7-year Mechanical Warranty on ND levers. Levers both sides.
- 3-year Mechanical Warranty on D knobs.
- UL Listed for 3-hour Fire Door.

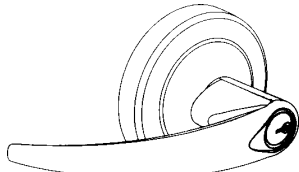

OMEGA (OME)
605, 613, 619, 626
(NS: 606, 612, 625)

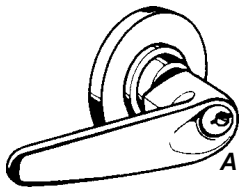

ATHENS (ATH)
605, 626
(NS: 606, 612, 613, 619, 625)

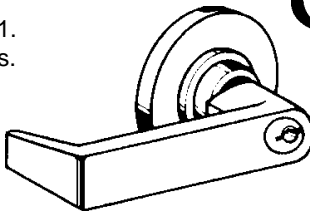

RHODES (RHO)
605, 612, 613, 619, 625, 626
(NS: 606)
Also stock BD, JD in 626

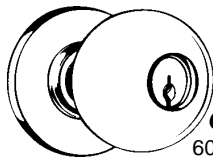

ORBIT (ORB)
605, 613, 625, 626
(NS: 606, 609, 610, 611, 612, 616, 629, 630)

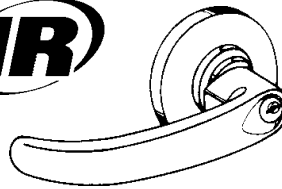

SPARTA (SPA)
605, 626
(NS: 606, 612, 613, 619, 625)



Lever Locks are handicapped approved

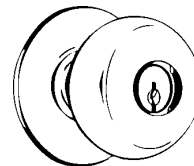

PLYMOUTH (PLY)
605, 612, 626
(NS: 606, 609, 610, 611, 613, 616, 625, 629, 630)

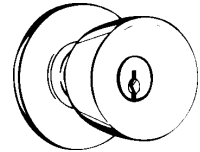

TULIP (TUL)
626
(NS: 605, 606, 609, 610, 611, 612, 613, 616, 625, 629, 630)

(NS) Non-stock finish available as factory special order.

Some finishes may have factory special handling charge.

606-Satin Brass; 609-Antique Brass; 610-Bright Brass, Blackened, Bright Relieved; 611-Bright Bronze; 616-Antique Bronze, Satin Bronze, Blackened, Satin Relieved; 629-Bright Stainless Steel; 630-Satin Stainless Steel.

To Order, Specify:

Function: **ND53PD** Entrance
Design: **RHO** Rhodes
Finish: **626** Satin Chrome
Latch: **234*** 2-3/4" Backset

Knob-D prefix
Lever-ND prefix

Not all functions are available in all designs/finishes

ND The change from D levers to ND levers is a rolling change effective November 10, 2003

Cylinder Options (Limited Selection-Please Call)

Just replace "PD" with...
LD- Less 6-Pin Cylinder. **23-030-C**
JD- Less Full Size Interchangeable Core. Pictured at right (RHO 626). **23-030-C123**
BD- Less SFIC-Small Format I/C (RHO 626) **23-030-C145**
23-030-E

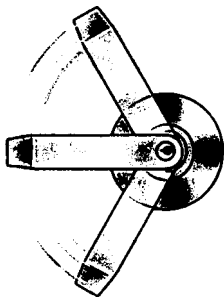
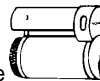

VANDLGARD™
Locked lever freely rotates up and down while remaining securely locked.
Functions: ND91PD, ND92PD, ND93PD, ND94PD and ND96PD.

Benefits/Features

- Extended Warranty
- Prohibits through bolt loosening
- Reduces lever wobble and play
- Resists vandalism
- Resists over-rotation of the lever

SPECIFICATIONS

See Spacer below for 1-3/8" door

DOOR THICKNESS: 1-3/8" to 2" (Knobs).
1-5/8" to 2-1/8" (Levers).

BACKSET: 2-3/4" standard, 2-3/8" available.
3-3/4" (price upcharge)

BORE: 2-1/8" x 1"

THROUGHBOLTS: On Levers: 5/16" diam. 2-3/4" center to center.

ROSE: 2-9/16" for knobs
3-7/16" for levers

KEY BLANKS: 35-100- 5 pin
35-101- 6 pin

KEYWAYS: PD-C Standard, 6-pin, keyed to 5 pin
E, F Optional in most cases. **EVEREST-** C123 or C145 also available.
LD- Less Cylinder-limited selection.
JD- Less Full Size Interchangeable Core-limited selection. (RHO 626).
BD- Less SFIC- limited selection in **RHO**.

FINISHES:
605(US-3) Bright Brass, clear coated
612(US-10) Satin Bronze, clear coated
613(US-10B) Oil Rubbed Bronze
619(US-15) Satin Nickel
625(US-26) Bright Chrome
626(US-26D) Satin Chrome

SPECIFY IF ASA STRIKE IS REQUIRED.

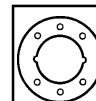

DJ-AR335 605, 613, 630
Spacer for installing lever lock on 1-3/8" door

*NOTE: On D & ND Series, 2-3/4" square face latch is standard. Specify if ASA strike is required.

©ZIPF LOCK COMPANY

SCHLAGE

D & ND SERIES FUNCTIONS

Function	No.	Operation	ANSI
PASSAGE	10S	Both knobs/levers always unlocked.	F75
ELECTRICALLY LOCKED-EXIT	12DEL	Outside lever continuously locked electrically. Unlocked by switch or power failure. Auxiliary latch deadlocks latchbolt when door is closed. Inside lever always free for immediate exit.	
ELECTRICALLY UNLOCKED-EXIT	12DEU	Outside lever continuously locked until unlocked by electric current. Auxiliary latch deadlocks latchbolt when door is closed. Inside lever always free for immediate exit.	
EXIT	25D	Blank plate outside. Inside knob always unlocked. FOR 1-3/4" THICK DOOR ONLY.	
BED/BEDROOM PRIVACY	40S	Push-button locking. Can be opened from outside with small screwdriver. Turning inside knob/lever or closing door releases button.	F76
HOSPITAL PRIVACY	44S	Push-button locking. Unlocked from outside by turning emergency turnbutton. Turning inside lever or closing door releases button.	
ENTRANCE	50PD	Push button locking. Push-button locks outside lever until unlocked with key or by turning inside lever. (1 cylinder)	F82
ENTRANCE	53PD	Turn/Push button locking: pushing and turning button locks outside knob/lever, requiring use of key until button is manually unlocked. Push-button locking: pushing button locks outside knob/lever until unlocked with key or by turning inside knob/lever. (1 cylinder)	F109
ENTRANCE with Vandlgard™	92PD	Turn/Push-button locking: pushing and turning button disengages outside lever, requiring use of key until button is manually unlocked. Push-button locking: pushing button disengages outside lever until unlocked by key or by turning inside lever. Vandlgard is designed to disengage outside spindle from latch when in locked condition. (1 cylinder)	F109
ENTRANCE/OFFICE with Vandlgard™	91PD	Push-button locking. Push-button disengages outside lever until unlocked with key or by turning inside lever. Vandlgard is designed to disengage outside spindle from latch when in locked condition. (1 cylinder)	F82
VESTIBULE-CLASSROOM SECURITY	60PD	Latch retracted by key from outside when outside knob/lever is locked by key in inside knob/lever. Inside knob/lever is always unlocked. (2 cylinders)	F88
VESTIBULE/CLASSROOM SECURITY with Vandlgard™	93PD	Latch retracted by key from outside when outside lever is disengaged by key in inside lever. Inside lever always unlocked. Vandlgard is designed to disengage outside spindle from latch when in locked condition. (2 cylinders)	F88
STORE	66PD*	Key in either knob/lever locks or unlocks both knobs/levers. (2 cylinders)	F91
CLASSROOM	70PD	Outside knob/lever locked and unlocked by key. Inside knob/lever always unlocked. (1 cyl)	F84
CLASSROOM with Vandlgard™	94PD	Outside lever disengaged and unlocked by key. Inside lever always unlocked. Vandlgard is designed to disengage outside spindle from latch when in locked condition. (1 cylinder)	F84
COMMUNICATING	72PD*	Key in either knob locks or unlocks each knob independently. (2 cylinders)	F80
CORRIDOR	73PD	Locked or unlocked by key from outside. Push-button locking from inside. Turning inside knob/lever or closing door releases button. When outside lever locked by key it can only be unlocked by key. Inside lever always unlocked. (1 cylinder)	F90
STOREROOM	80PD	Outside knob/lever fixed. Entrance by key only. Inside knob/lever always unlocked. (1 cyl)	F86
STOREROOM with Vandlgard™	96PD	Outside lever always disengaged. Entrance by key only. Inside lever always unlocked. Vandlgard is designed to disengage outside spindle from latch when in locked condition. (1 cyl)	F86
ELECTRICALLY LOCKED	80PDEL	Outside knob continuously locked electrically. Unlocked by key outside or by switch or power failure. Auxiliary latch deadlocks latchbolt when door is closed. Inside knob always free for immediate exit. Amps .15; Volts 24 AC only. (1 cylinder) - Fail Safe.	
ELECTRICALLY UNLOCKED	80PDEU	Outside knob continuously locked until unlocked by key or electric current. Auxiliary latch deadlocks latchbolt when door is closed. Inside knob always free for immediate exit. Amps .15; Volts 24 AC. Amps .35; Volts 24DC. DC operation intermittent duty only. (1 cyl) - Fail Secure.	
INSTITUTION	82PD*	Both knobs/levers fixed. Entrance by key in either knob/lever. (2 cylinders)	F87
SINGLE DUMMY	170	Single dummy trim for one side of door. Used for door pull or as matching inactive trim.	

***Caution:** Double cylinder locks on residences and any door in any structure which is used for egress are a life safety hazard in times of emergency and their use is not recommended. Installation should be in accordance with existing codes only.

• **Not all functions are available in all designs** •

ZIPF LOCK COMPANY
175
 (PL-10)

SCHLAGE

6 locks per case

FE SERIES ELECTRONICS



Keypad Entry Locks

- ANSI A156.2-2003 bored locks and latches.
- ANSI A156.5-2001 Grade 2 cylinders.
- Residential Lifetime Mechanical Warranty.
- Residential Lifetime Finish Warranty.
- FCC Part 15, CE Mark.

FE575 Auto-Lock

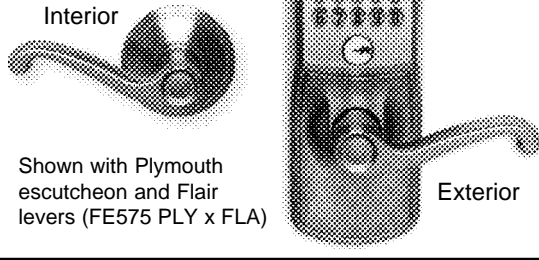

FE595 Flex-Lock

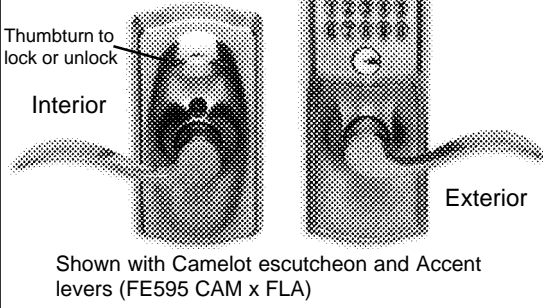

FE575 Auto-Lock Feature

Schlage Keypad locks with the Auto-Lock feature automatically re-lock five seconds after use, providing complete confidence and protection for your family and valuables. Ideal for use on doors leading to basement stairways, storage and utility rooms, workshops and more.

FE595 Flex-Lock Feature

Schlage Keypad locks with the Flex-Lock feature allow homeowners to choose whether their door remains locked (with a code required for entry) or unlocked (no code required for entry) simply by rotating the inside thumbturn. This added layer of protection ensures that valuables and family members are safe, and ideal for garage entry doors, home offices, storage rooms and more.

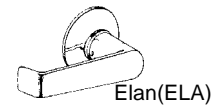
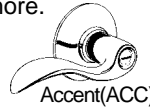

Function	Design	Finish	Inside Design	Image
FE575	CAM	***	ACC	Flair(FLA)
FE575	PLY	626	ELA	
FE575	PLY	***	FLA	
FE575	PLY	626	JAZ	Georgian(GEO)
FE575	PLY	505	PLY	
FE595	CAM	***	ACC	Jazz(JAZ)
FE595	CAM	505	GEO	
FE595	CAM	609	GEO	
FE595	CAM	619	GEO	
FE595	PLY	626	ELA	
FE595	PLY	***	FLA	
FE595	PLY	626	JAZ	Plymouth(PLY)

***Specify Finish: 505,609,613,619,620,625,626,716

**Example—
FE595 CAM 620 ACC**

SPECIFICATIONS

DOOR THICKNESS:	1-3/8" to 1-3/4"
BACKSET:	3AL-Adjustable latch for 2-3/8", 2-3/4" with Square Face/Round Face/Drive-in. Both RCS, SCS.
STRIKE:	2-1/8" X 7/8" standard latch
BORE:	2-1/8" x 1" drive-in latch
KEY BLANK:	35-100-C
KEYWAYS:	C Standard, 5-pin
FINISHES:	505 ULTIMA™, Bright Brass 609(US-5) Antique Brass, clear coated 613(US-10B) Oil Rubbed Bronze* 619(US-15) Satin Nickel Plated 620(US-15A) Antique Pewter 625(US-26) Bright Chrome 626(US-26D) Satin Chrome 716 New Aged Bronze

*613 is a living finish and will wear and change appearance over time

Security and Quality

- Grade 2 ANSI/BHMA certified
- Patented commercial grade clutching motor drive: tested to one million cycles.
- Vandal resistant clutching lever and knob design.
- Code control, 6-digit programming code required to add and delete user codes.
- Warning code sounds after 4 incorrect codes entered; keypad disabled for 30 seconds.
- Mechanical key override: patent pending.

Convenience

- Convenient keyless access; no keys to hide, lose or forget.
- Pre-set with random 6-digit programming code and two random 4-digit user codes.
- 19 user code capacity; 10,000 user code combinations.
- Easily programmed right at the keypad; no need to remove inside escutcheon.
- Blue LEDs illuminate the keypad on demand.
- Reversible levers for left- or right-handed doors.
- Emergency exit feature; allows for panic-free exit.
- Locks can be rekeyed to match existing locks.
- 9-volt alkaline battery included.

©ZIPF LOCK COMPANY

SCHLAGE

6 locks per case

BE SERIES ELECTRONICS

Keypad Deadbolts

- Grade 2 ANSI/BHMA certified.
- ANSI A156.5-2001 Grade 2 auxiliary locks.
- Residential Lifetime Mechanical Warranty.
- Residential Lifetime Finish Warranty.
- FCC Part 15, CE Mark.



BE365 with Turn-Lock Feature

Schlage Keypad Deadbolts bring professional grade security with the convenience of keyless access to the home. The innovative Turn-Lock feature allows the user to lock and leave without a key. Ideal for front, back and side entry doors where deadbolts are required.

Security and Quality

- Grade 2 ANSI/BHMA certified
- Patented commercial grade clutching motor drive: tested to one million cycles.
- Vandal resistant free spinning deadbolt turn.
- Code control, 6-digit programming code required to add and delete user codes.
- Warning code sounds after 4 incorrect codes entered; keypad disabled for 30 seconds.
- Mechanical key override: patent pending.

Convenience

- Convenient keyless access; no keys to hide, lose or forget.
- Pre-set with random 6-digit programming code and two random 4-digit user codes.
- 19 user code capacity; 10,000 user code combinations.
- Easily programmed right at the keypad; no need to remove inside escutcheon.
- Blue LEDs illuminate the keypad on demand.
- Locks can be rekeyed to match existing locks.
- 9-volt alkaline battery included.

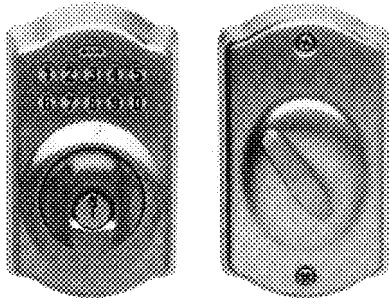

Shown with Camelot escutcheon

Exterior

Interior

SPECIFICATIONS

- DOOR THICKNESS:** 1-3/8" to 1-3/4"
BACKSET: 3AL-Adjustable latch for 2-3/8", 2-3/4" with Square Face/Round Face/Drive-in. SCS.
STRIKE:
BORE: 2-1/8" X 7/8" standard latch
 2-1/8" x 1" drive-in latch
KEY BLANK: 35-100-C
KEYWAYS: C Standard, 5-pin
FINISHES:
- | | |
|--------------------|-----------------------------|
| 505 | ULTIMA™, Bright Brass |
| 609(US-5) | Antique Brass, clear coated |
| 613(US-10B) | Oil Rubbed Bronze* |
| 619(US-15) | Satin Nickel Plated |
| 620(US-15A) | Antique Pewter |
| 625(US-26) | Bright Chrome |
| 626(US-26D) | Satin Chrome |
| 716 | New Aged Bronze |

*613 is a living finish and will wear and change appearance over time

Stock No. Description

- BE365 CAM** with Camelot escutcheon
BE365 PLY with Plymouth escutcheon
 •Specify finish when ordering.

FE SERIES for ELECTONICS

Keypad Front Entry (Bottom Half)

- Residential Lifetime Mechanical Warranty.
- Residential Lifetime Finish Warranty.

FE285 Front Entry (bottom half) Handleset

Combine Schlage's Keypad Deadbolt (shown above) with the FE285 Front Entry to get a complete Handleset with keypad access. All FE285 are stocked with the interior knob/lever. See chart below for availability.

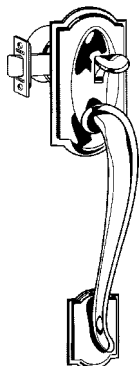

Camelot (CAM)

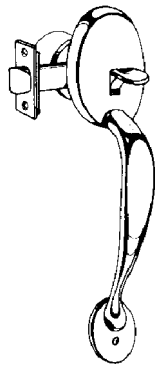

Plymouth (PLY)

Function	Escutcheon		Inside		***Finish (specify)
	Design	Finish	Design	Hand	
FE285	CAM	***	ACC	LH	505,619,620,716
FE285	CAM	***	ACC	RH	505,619,620,716
FE285	CAM	***	GEO		505,609,619,716
FE285	PLY	***	FLA	LH	505,609,613,619,620,625,626,716
FE285	PLY	***	FLA	RH	505,609,613,619,620,625,626,716
FE285	PLY	***	PLY		505,613



Accent(ACC)



Flair(FLA)



Georgian(GEO)

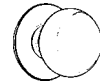

Plymouth(PLY)

©ZIPF LOCK COMPANY

SCHLAGE

FA SERIES

ACCENTS™
Timeless beauty

8 locks per case

For Standard Duty Residential

- ANSI A156.2, 1996, Series 4000, Grade 2.
- Residential Lifetime Mechanical Warranty.
- Residential Lifetime Finish Warranty.
- Field reversible levers (FA10, FA40, FA51).

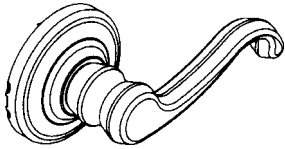

CALLINGTON (CLT)
505, 605, 609, 613,
619, 620, 625, 626, 716
(FA170 Specify Hand)

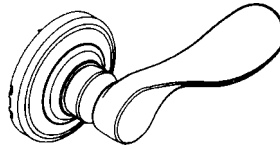

CHAMPAGNE (CHP)
505, 605, 609, 613,
619, 620, 625, 626, 716
(FA170 Specify Hand)

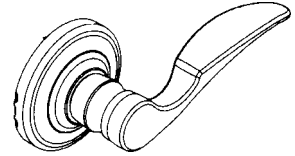

ST ANNES (STA)
505, 605, 609, 613,
619, 620, 625, 626, 716
(FA170 Specify Hand)

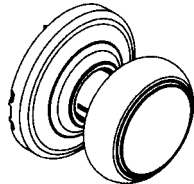

ANDOVER (AND)
505, 605, 609, 613,
619, 620, 625, 626, 716

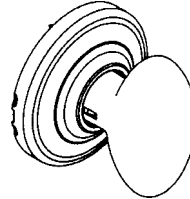

DANBURY (DNB)
505, 605, 609, 613,
619, 620, 625, 626, 716

Function	No.	Operation	ANSI
PASSAGE	FA10	Both knobs/levers are always unlocked.	F75
BATH/BEDROOM PRIVACY	FA40	Push-button locking. Can be opened from outside with small circular tool. Turning inside knob/lever releases button.	F76
ENTRANCE	FA51	Turn button locking. Unlocked by key outside or by turn button inside. Inside lever/knob always unlocked.	F81
SINGLE DUMMY	FA170	Single dummy trim for one side of door. Used for door pull or as matching inactive trim.	

To Order, Specify:

Function: **FA51** Entrance
Design: **CLT** Callington
Finish: **605** Bright Brass
* Handing required on CHP, CLT, STA dummy.

SPECIFICATIONS

DOOR THICKNESS: 1-3/8" to 1-3/4"
BACKSET: 3AL-Adjustable latch for 2-3/8", 2-3/4" with Square Face/Round Face/Drive-in.
STRIKE: Both RCS, SCS.
BORE: 2-1/8" X 7/8" standard latch
2-1/8" x 1" drive-in latch
ROSE: 2-3/4"
KEY BLANK: 35-025-C 5 pin Accents Bow
KEYWAYS: C Standard, 5-pin
FINISHES:
505 ULTIMA™, Bright Brass
605 (US-3) Bright Brass, clear coated
609 (US-5) Antique Brass, clear coated
613 (US-10B) Oil Rubbed Bronze*
619 (US-15) Satin Nickel Plated
620 (US-15A) Antique Pewter
625 (US-26) Bright Chrome
626 (US-26D) Satin Chrome
716 New Aged Bronze

*613 is a living finish and will wear and change appearance over time

BA SERIES

8 locks per case

For Standard Duty Residential

- ANSI A156.5, 2001, Grade 2 auxiliary lock
- Residential Lifetime Mechanical Warranty.
- Residential Lifetime Finish Warranty.
- Door frame strike reinforcer with 3" screws.
- 7/8" wrought brass, reinforced trim ring with security inserts.

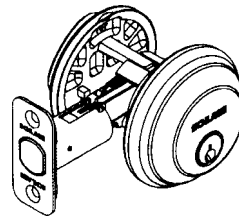

Stock No.	Description
BA360	Single Cylinder
BA362	Double Cylinder
505, 605, 609, 613, 619, 620, 625, 626, 716	

TO ORDER, SPECIFY:

Stock No.	Finish (example)
BA360	619

SPECIFICATIONS

DOOR THICKNESS: 1-3/8" to 2"
BACKSET: 3AL-Triple Option Adjustable Latch
STRIKE: Both RCS, SCS.
BORE: 2-1/8" X 7/8" standard latch
2-1/8" x 1" drive-in latch
FINISHES: Same as FA locks.

SCHLAGE

F SERIES



20 locks per case
Dummy - 30 locks per case

For Standard Duty Residential

- ANSI A156.2, 1996, Series 4000, Grade 2.
- Residential Lifetime Mechanical Warranty.
- Residential 10-year Finish Warranty (605/609/626).
- Residential 505-Ultima™ Lifetime Finish.
- Residential Artisan Lifetime Finish(613/619/620/625).



Levers meet applicable
ADA accessibility
codes.



ACCENT (ACC)
605, 609, 613, 619, 620, 625, 716
(F10, F51 also 505)
(Specify Hand - LH or RH)

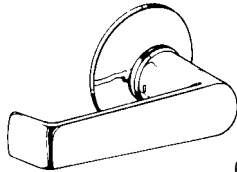

ELAN (ELA)
605, 609, 626
(Keyed Locks have
knob outside)

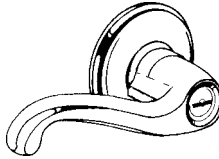

FLAIR (FLA)
605, 609, 613, 619, 620, 625, 626, 716
(F10, F51 also 505)
(Specify Hand - LH or RH)

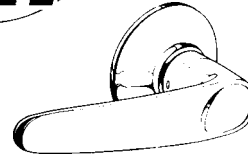

JAZZ (JAZ)
605, 619
(Keyed Locks have
knob outside)

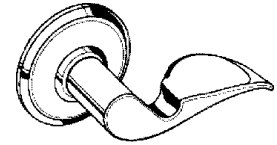

AVANTI (AVA)
605, 609, 613, 619, 620, 625, 716
(F10, F51 also 505)
(Specify Hand for dummy)

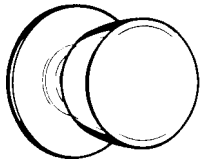

BELL (BEL)
605, 609, 626
(F10, F51 also 505)
(Also F40 in 605/625)

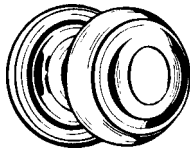

GEORGIAN (GEO)
605, 609, 619, 620, 625, 716
(F10, F51, F54 also 505)

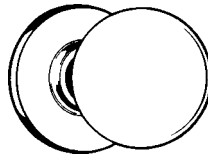

ORBIT (ORB)
605, 609, 613, 619, 620,
625, 626
(F10, F51, F54 also 505)

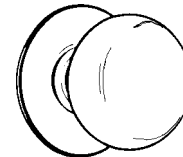

PLYMOUTH (PLY)
605, 613, 619, 620, 625,
626, 716
(F10, F51, F54 also 505)
(Also F40 in 605/625)

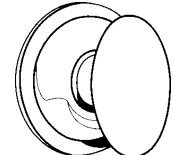

SIENNA (SIE)
605, 609, 613, 619,
620, 625, 716
(F10, F51 also 505)

Function	No.	Operation	ANSI
PASSAGE	F10	Both knobs/levers are always unlocked.	F75
BATH/BEDROOM PRIVACY	F40	Push-button locking. Can be opened from outside with small circular tool. Turning inside knob/lever releases button.	F76
ENTRANCE	F51	Unlocked by key from outside when outer knob/lever is locked by turn button in inside knob/lever. Inside knob/lever always unlocked.	F81
ENTRANCE	F54	Key from outside or turnbutton inside locks or unlocks <u>both knobs</u> . (knobs only)	
STOREROOM	F80	Outside knob fixed. Entrance by key only. Inside knob/lever always unlocked.	F86
SINGLE DUMMY	F170	Single dummy trim for one side of door. Used for door pull or as matching inactive trim.	

SPECIFICATIONS

DOOR THICKNESS: 1-3/8" to 1-7/8"
***BACKSET:** 3AL-Adjustable latch for 2-3/8", 2-3/4" with Square Face/Round Face/Drive-in. AL-Adjustable 2-3/8" to 2-3/4" SCL. RCL-Round Corner Adjustable Latch.
***STRIKE:** RCS, SCS. 3AL has both strikes. *Selection may be limited.
BORE: 2-1/8" X 7/8" standard latch
 2-1/8" x 1" drive-in latch
ROSE: 2-3/4"
KEY BLANKS: 35-100- 5 pin
KEYWAYS: C Standard, 5-pin
FINISHES:
505 Bright Brass, ULTIMA™-Lifetime
605 (US-3) Bright Brass, clear coated
609 (US-5) Antique Brass, clear coated
613 (US-10B) Oil Rubbed Bronze-Artisan Lifetime
619 (US-15) Satin Nickel Plated-Artisan Lifetime

To Order, Specify:

Function: **F51** Entrance
 Design: **FLA** Flair
 Finish: **605** Bright Brass
 *Handing: **RH** Right Hand
 Latch: **3AL Triple Option Latch
 * Handing required on ACC, AVA, FLA, dummies. (SEE PAGE 186 FOR DETERMINING HANDING)
 Please specify latch. Selection may be limited. Some locks **ONLY available with Triple Option Latch (3AL).
Not all functions are available in all designs/finishes

620 (US-15A) Antique Pewter-Artisan Lifetime
625 (US-26) Bright Chrome-Artisan Lifetime
626 (US-26D) Satin Chrome
716 New Aged Bronze

*613 is a living finish and will wear and change appearance over time

©ZIPF LOCK COMPANY

SCHLAGE

S SERIES FLAIR

For Heavy Duty Residential and Standard Duty Commercial

- ANSI A156.2, 1996, Series 4000, Grade 2.
- U.L. Listed for 3-hour Fire Door.
- 3-year Mechanical Warranty. (Exclusion: Key-in-lever used on educational facilities)
- Levers BOTH Sides.

SCHLAGE

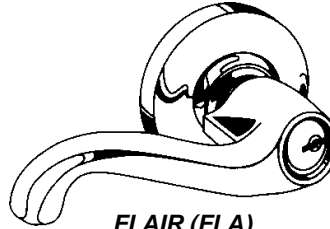

FLAIR (FLA)
605
(Specify Handing)



JUP, NEP, SAT
designs
Available by
Special Order

6 locks per case



Complies with
A.D.A.
requirements

To Order, Specify:

Function: **S51PD** Entrance

Design: **FLA** Flair

Finish: **605** Bright Brass

Handing: **RH** Right Hand

NOTE: Lock only available with Universal (AL) backset latch to fit either 2-3/8" or 2-3/4" backsets.

Cylinder Options (Limited Selection-Please Call)

Just replace "PD" with...

LD- Less 6-Pin Cylinder.

COMMERCIAL APPLICATIONS
CONTRACTOR

Apollo CSV see below.

SPECIFICATIONS

DOOR THICKNESS: 1-3/8" to 2".

1-3/8" to 1-7/8" for S40D.

BACKSET: Adjustable 2-3/8" to 2-3/4" SCL.

BORE: 2-1/8" x 7/8"

ROSE: 2-9/16".

KEY BLANKS: 35-100- 5 pin

35-101- 6 pin

KEYWAYS: PD-C Standard, 6-pin, keyed to 5 pin

E, F Optional in most cases. **EVEREST-** C123 or C145 also available.

LD-Less Cylinder-limited selection.

FINISHES: **605** (US-3) Bright Brass, clear coated

<u>Function</u>	<u>No.</u>	<u>Operation</u>	<u>ANSI</u>
PASSAGE	S10D	Both levers always unlocked.	F75
BATH/BEDROOM PRIVACY	S40D	Push-button locking. Can be unlocked from outside with small circular tool. Turning inside lever releases button. Closing the door does not release button (restoring).	F76
ENTRANCE	S51PD	Unlocked by key from outside when outside lever is locked by turn-button in inside lever. Inside lever always unlocked. (1 cylinder)	F81
CLASSROOM	S70PD	Outside lever locked and unlocked by key. Inside lever always unlocked. (1 cylinder)	F84
STOREROOM	S80PD	Outside lever fixed. Entrance by key only. Inside lever always unlocked. (1 cylinder)	F86
SINGLE DUMMY	S170	Single dummy trim for one side of door. Used for door pull or as matching inactive trim.	

CONTRACTOR SERIES

COMMERCIAL APPLICATIONS
CONTRACTOR

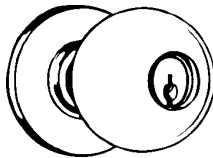

ORBIT (ORB)

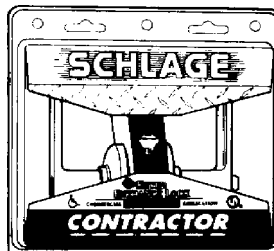

ANSI Grade 2
U.L. Listed
Nickel Silver Keys and pins
T-strike 10-001
Die Cast Cylinder

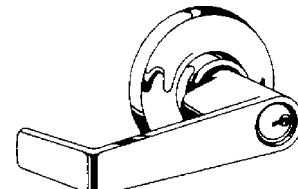

APOLLO (APO)

<u>Stock No.</u>	<u>Function</u>
A53CSV ORB 605 234	Entrance
A53CSV ORB 626 234	Entrance
A80CSV ORB 626 234	Storeroom

<u>Stock No.</u>	<u>Function</u>
S51CSV APO 605 AL	Entrance
S51CSV APO 626 AL	Entrance

©ZIPF LOCK COMPANY

SCHLAGE

12 locks per case

B600 SERIES



For Heavy Duty Residential & Commercial

- ANSI A156.5, 2001, Grade 1. U.L. Listed, 3-hour.
- 1" Throw Steel Alloy Deadbolt Containing a Hardened Steel Roller to Prevent Cutting.
- Solid Brass or Bronze Rotating Trim Ring.
- Mounting Screws Protected Against Drilling by Steel Balls.
- 3-year Mechanical Warranty.

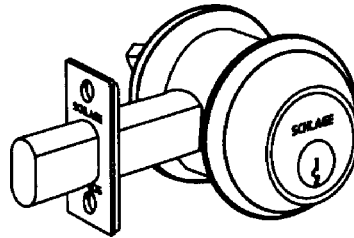

Function	No.	Operation	ANSI
SINGLE CYLINDER	B660P	Deadbolt thrown or retracted by key from outside or by inside turn unit. Bolt automatically deadlocks when fully thrown.	E2151
DOUBLE CYLINDER	B662P*	Deadbolt thrown or retracted by key from either side. Bolt automatically deadlocks when fully thrown.	E2141

SPECIFICATIONS

- DOOR THICKNESS:** 1-5/8" to 2"
BACKSET: 2-3/8", 2-3/4" SCL w/1-1/8" wide face
BORE: 1-1/2" or 2-1/8" x 1"(1-1/16" for Drive-in bolt)
KEY BLANKS: 35-100- 5-pin; 35-101- 6-pin
KEYWAYS: P-C Standard, 6-pin, keyed to 5 pin
 E, F Optional in most cases. **EVEREST-**
 C123 or C145 also available.
J-Less Full Size Interchangeable Core-
 limited selection (626).
BD-Less SFIC- limited selection (626).
FINISHES:
605 (US-3) Bright Brass, clear coated
609 (US-5) Antique Brass, clear coated
613 (US-10B) Oil Rubbed Bronze
619 (US-15) Satin Nickel
626 (US-26D) Satin Chrome

To Order, Specify:

Function: **B660P** Single Cylinder
 Finish: **626** Satin Chrome
 Latch: **234** 2-3/4" Backset

Cylinder Options (Limited Selection-Please Call)

Just replace "P" with...

- | | | |
|--|--|--|
| J- Less Full Size Interchangeable Core. Pictured at right. (626) |  | 23-030-C
23-030-C123
23-030-C145
23-030-E |
| BD-Less SFIC-Small Format I/C (626) | | |

BC100 SERIES



20 locks per case

For Heavy Duty Residential & Commercial

- ANSI A156.5, 2001, Grade 2.
- 1" Throw, With Concealed Hardened Steel Roller.
- 3-year Mechanical Warranty.

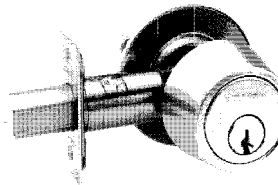

No.	Operation	ANSI
BC160P	SINGLE CYLINDER -Deadbolt thrown or retracted by key from outside or by inside turn unit. Bolt automatically deadlocks when fully thrown. (ANSI E2152)	
BC162P*	DOUBLE CYLINDER -Deadbolt thrown or retracted by key from either side. Bolt automatically deadlocks when fully thrown. (ANSI E2142)	
BC180	DOOR BOLT -Deadbolt thrown or retracted by turn unit only. No outside trim. Bolt automatically deadlocks when fully thrown. (ANSI E2192)	

SPECIFICATIONS

- DOOR THICKNESS:** 1-3/8" to 1-3/4"
BACKSET: AL-Adjustable for 2-3/8" or 2-3/4" Sq. Corner. Some locks may be available with the 3AL-Adjustable latch for 2-3/8", 2-3/4" with Square Face/Round Face/Drive-in.
BORE: 1-1/2" or 2-1/8" x 1"
KEY BLANKS: 35-100- 5-pin; 35-101- 6-pin
KEYWAYS: P-C Standard, 6-pin, keyed to 5 pin
 E, F Optional in most cases. **EVEREST-**
 C123 also available.
J-Less Full Size Interchangeable Core-
 limited selection (626).
BD-Less SFIC- limited selection (626).
L-Less cylinder- limited selection (626)
FINISHES:
605 (US-3) Bright Brass, clear coated
609 (US-5) Antique Brass, clear coated
612 (US-10) Satin Bronze, clear coated
613 (US-10B) Oil Rubbed Bronze
625 (US-26) Bright Chrome
626 (US-26D) Satin Chrome

To Order, Specify:

Function: **BC160P** Single Cylinder
 Finish: **626** Satin Chrome
 Latch: **AL** Adjustable Backset

Cylinder Options (Limited Selection-Please Call)

Just replace "P" with...

- | | | |
|--|---|--|
| J- Less Full Size Interchangeable Core. Pictured at right. (626) |  | 23-030-C
23-030-C123
23-030-C145
23-030-E |
| BD-Less SFIC-Small Format I/C (626) | | |
| L- Less cylinder (BC160L 626 only) | | |

***Caution:** Double cylinder locks on residences and any door in any structure which is used for egress are a life safety hazard in times of emergency and their use is not recommended. Installation should be in accordance with existing codes only.

181_{v1}
(PL-10)

©ZIPF LOCK COMPANY

SCHLAGE

20 locks per case

B200 SERIES NIGHTLATCH



For Residential & Commercial

- ANSI A156.5, 2001, Grade 2
- 9/16" Throw Deadlatch That Prevents "shimming" The Bolt With a Credit Card or Similar Tool.
- Trim Rings are Reinforced With Hardened Steel Inserts.
- A "hold-back" Feature Retains the Deadlatch in a Retracted Position When Desired.
- 3-year Mechanical Warranty.

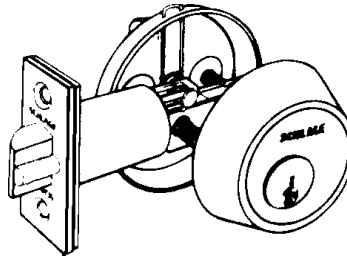

Function	No.	Operation	ANSI
NIGHT LATCH	B250PD	Deadlocking latchbolt retracted by key from outside or by inside turn unit. Rotating turn unit and activating hold-back feature keeps latch retracted.	E2122
DBL. CYLINDER DEADLATCH	B252PD*	Deadlocking latchbolt retracted by key from either side. No holdback feature.	E2112

To Order, Specify:

Function: **B250PD** *Single Cylinder*
 Finish: **626** *Satin Chrome*
 Latch: **234** *2-3/4" Backset*

SPECIFICATIONS

DOOR THICKNESS: 1-3/8" to 1-3/4"
BACKSET: 2-3/8" or 2-3/4"
BORE: 1-1/2"
BOLT THROW: 9/16"
KEY BLANK: 35-100-C 5-pin
KEYWAYS: C Standard, 5-pin
FINISHES: **605** (US-3) Bright Brass, clear coated
626 (US-26D) Satin Chrome

BR200 SERIES



20 locks per case

For Residential & Commercial

- ANSI A156.5, 1992, Grade 2
- 1" Bolt Throw with Concealed Hardened Steel Roller to Resist Cutting or Sawing the Latchbolt.
- Reinforced Trim Ring Rotates to Protect Against Wrenching the Cylinder.
- Residential Lifetime Mechanical Warranty.
- Residential 10-year Finish Warranty.
- Residential 505-Ultima™ Lifetime Finish.

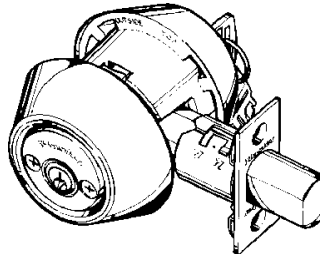

Limited supply -
Discontinued by factory.

Function	No.	Operation	ANSI
SINGLE CYLINDER	BR260	Deadbolt thrown or retracted by key from outside or by inside turn unit. Bolt automatically deadlocks when fully thrown.	E2152
DOUBLE CYLINDER	BR262*	Deadbolt thrown or retracted by key from either side. Bolt automatically deadlocks when fully thrown.	E2142

SPECIFICATIONS

DOOR THICKNESS: 1-3/8" to 1-3/4"
BACKSET: 3AL-Adjustable latch for 2-3/8", 2-3/4" with Square Face/Round Face/Drive-in.
BORE: 2-1/8" x 1"
KEY BLANK : 35-100-C 5 pin
KEYWAYS: C Standard, 5-pin
FINISHES: **505** Bright Brass, ULTIMA™-Lifetime
605 (US-3) Bright Brass, clear coated
609 (US-5) Antique Brass, clear coated
625 (US-26) Bright Chrome
626 (US-26D) Satin Chrome

To Order, Specify:

Function: **BR260** *Single Cylinder*
 Finish: **605** *Bright Brass*
 Latch: **3AL** *Triple Option Latch*

SCHLAGE

See pages 178 for ACCENTS Series, page 177 for electronic deadbolt

B300 SERIES



20 locks per case

For Heavy Duty Residential/Light Duty Commercial

- ANSI A156.5, 2001, Grade 2.
- 1" Throw Deadbolt with Concealed Hardened Steel Roller to Prevent Cutting or Sawing the Bolt.
- Concealed Spin Ring Rotates to Protect Against Wrenching the Cylinder.
- Solid Brass 5-pin Cylinder. Pick Resistant Spool Pins.
- Solid Steel Door Frame Reinforcer with 3" Screws Protects Against Kick-in Attack.
- Residential Lifetime Mechanical Warranty.
- Residential 10-year Finish Warranty (605/609/626).
- Residential 505-Ultima™ Lifetime Finish.
- Residential Artisan Lifetime Finish(613/619/620/625).

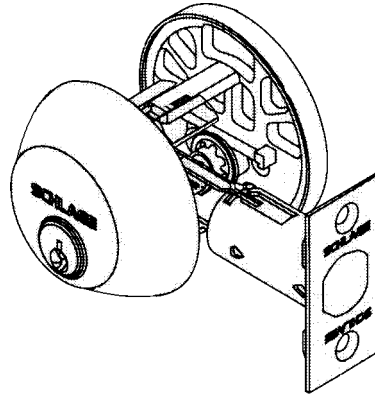

Function	No.	Operation	ANSI
SINGLE CYLINDER	B360N	Deadbolt thrown or retracted by key from outside or by inside turn unit. Bolt automatically deadlocks when fully thrown.	E2152
DOUBLE CYLINDER	B362N*	Deadbolt thrown or retracted by key from either side. Bolt automatically deadlocks when fully thrown.	E2142

To Order, Specify:

Function: **B360N** *Single Cylinder*
 Finish: **619** *Satin Nickel Plated*
 Latch: **3AL** *Triple Option Latch*

SPECIFICATIONS

DOOR THICKNESS: 1-3/8" to 1-3/4"
BACKSET: Adjustable 2-3/8" to 2-3/4" with square, round corner and Drive-in faces
BORE: 1-1/2" or 2-1/8" x 1"
KEY BLANK: 35-100-C 5-pin
KEYWAYS: C Standard, 5-pin
FINISHES:
505 Bright Brass, ULTIMA™-Lifetime
605 (US-3) Bright Brass, clear coated
609 (US-5) Antique Brass, clear coated
613 (US-10B) Oil Rubbed Bronze-Artisan Lifetime
619 (US-15) Satin Nickel Plated-Artisan Lifetime
620 (US-15A) Antique Pewter-Artisan Lifetime
625 (US-26) Bright Chrome-Artisan Lifetime
626 (US-26D) Satin Chrome
716 New Aged Bronze

*613 is a living finish and will wear and change appearance over time

FB300 SERIES

6 sets per case

Maximum Security Combo Pack

- Keyed Alike for Double Security.
- Same Key Operates Both Deadbolt and Keyed Entry Lock.

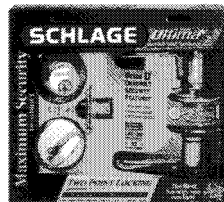

No.	Operation
FB350NV	SINGLE CYLINDER -Keyed alike entry lock (F51) and 1" throw deadbolt (B360N). Furnished with 4 keys.

To Order, Specify:

Function: **FB350NV** *Combo Pack*
****Design:** **ACC** *Accent*
Finish: **505** *Bright Brass, Ultima™ Lifetime*
Latch: **3AL** *Triple Option Latch*
*****Handing:** **RH** *Right Hand*

*Available in the following Designs:
ACC 505; BEL 505; FLA 505; GEO 505, 609; PLY 505.
*****HANDING** required on Accent and Flair (RH or LH).

TRIPLE OPTION LATCH-

With the Triple Option Latch you have 6 latches in 1. Adjustable for 2-3/8" and 2-3/4" backsets. You can snap on the face that you need: square corner, round corner or drive-in. **Also 2 strikes:** 1 square and 1 round corner. Now you can be ready for any door.

This latch is available on BR200 Series, B300 Series, FB350 Series, FB Handles and most F locks we stock. Just specify latch (**3AL**) when ordering locks.

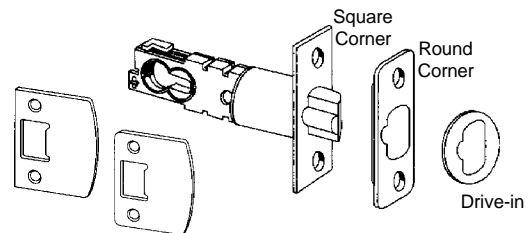

***Caution:** Double cylinder locks on residences and any door in any structure which is used for egress are a life safety hazard in times of emergency and their use is not recommended. Installation should be in accordance with existing codes only.

SCHLAGE

FA SERIES

ACCENTS™
Timeless Beauty

4 locks per case

For Standard Duty Residential

- ANSI A156.5, 2001, Grade 2 auxiliary lock.
- Residential Lifetime Mechanical Warranty.
- Residential Lifetime Finish Warranty.
- Door frame strike reinforcer with 3" screws.
- 7/8" wrought brass, reinforced trim ring with security inserts.



Interior Packs

- FA359** For Locking Handles
- FA394** For Dummy Handles

Interior Pack Designs

- Andover (**AND**)
- Callington (**CLT**)
- Champagne (**CHP**)
- Danbury (**DNB**)
- St Annes (**STA**)

To Order, Specify:

For handle-(exterior only)

Handle No.: **FA358 VEN**
Finish: **619**

For interior pack-(designs shown below)

Interior No.: **FA359**

Design: **CHP**

*Escutcheon: **/VEN**

Finish: **619**

Handing: **LH

*Specify Escutcheon design when ordering one piece interiors.

**Required on levers.

Also Chantilly		Also Kent		Also Ashcroft		
FLORENCE FA358 FLO FA392 FLO	MONTICELLO FA358 MNT FA392 MNT	MONACO FA358 MON FA392 MON	SUTTON FA358 STN FA392 STN	VENICE FA358 VEN FA392 VEN	WAKEFIELD FA358 WKF FA392 WKF	FUNCTION <i>Locking Handle</i> <i>Dummy Handle</i>
505,605,609,613,619 620,625,626,716	505,605,609,613,619 620,625,626	505,605,609,613,619 620,625,626,716	505,605,609,613,619 620,625,626	505,605,609,613,619 620,625,626,716	505,605,609,613,619 620,625,626,716	

•ALL HANDLES ARE SOLD LESS INTERIOR PACK (YOU MUST ORDER SEPARATELY)•

SPECIFICATIONS

- DOOR THICK.:** 1-5/8" to 2"
BACKSET: 3AL-Adjustable latch for 2-3/8", 2-3/4" with Square Face/Round Face/Drive-in. RCS & SCS strike for bottom latch.
STRIKE: Deadlock has square corner strike.
BORE: 1-1/2" or 2-1/8" for deadlock. 2-1/8" for handle.
SPACING: 5-1/2 center to center
DEADBOLT: BA360, 1" throw.
KEY BLANK: 35-025-C 5-pin Accents Bow
KEYWAY: C Standard, 5-pin
FINISHES:
505 ULTIMA™, Bright Brass
605 (US-3) Bright Brass, clear coated
609 (US-5) Antique Brass, clear coated
613 (US-10B) Oil Rubbed Bronze*
619 (US-15) Satin Nickel Plated
620 (US-15A) Antique Pewter
625 (US-26) Bright Chrome
626 (US-26D) Satin Chrome
716 New Aged Bronze

*613 is a living finish and will wear and change appearance over time.

Adjustable Through-posts



All Accents Handles include an adjustable through-bolt post for easier installation and effortless capability. The post simply adjust up and down to better align with the lower mounting hole. This feature allows retrofit of over 70% of competitors' handlesets.

INTERIOR DESIGNS

(Specify if using with F359 inside trims)

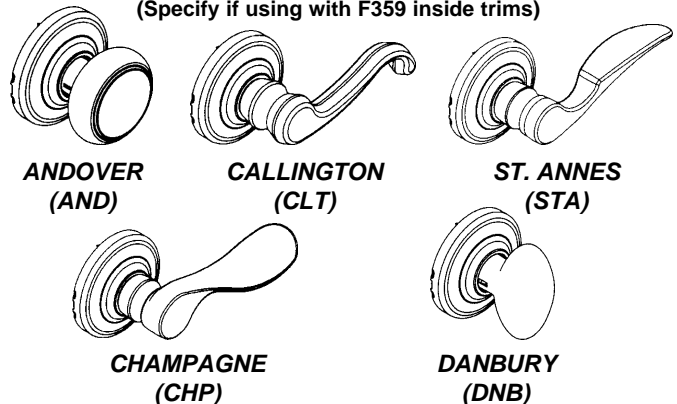

STANDARD

ONE PIECE ESCUTCHEONS

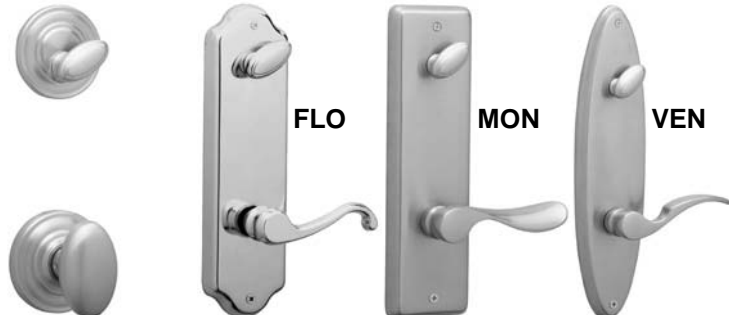

©ZIPF LOCK COMPANY

184 v1
(PL-10)

HANDLE PACK CONTAINS: Handle, deadbolt cylinder, screw for handle bottom and 4 keys.

INTERIOR PACK CONTAINS: 1 knob/lever, 1 thumbturn for deadlock, strikes, cover trim and 2 latches.

SCHLAGE

4 locks per case

F SERIES



For Standard Duty Residential Entrance Doors

- ANSI A156.5, 2001, Grade 2. Auxiliary Lock.
- Residential Lifetime Mechanical Warranty.
- Residential 10-year Finish Warranty (605/609/626).
- Residential 505-Ultima™ Lifetime Finish.
- Residential Artisan Lifetime Finish(613/619/620/625)
- Solid Forged Brass Grip Handle.



Interior Packs

F359 For Locking Handles

F394 For Dummy Handles

Interior Pack Designs

Accent (**ACC**)

Avanti (**AVA**)

Elan (**ELA**)

Flair (**FLA**)

Georgian (**GEO**)

Jazz (**JAZ**)

Orbit (**ORB**)

Plymouth (**PLY**)

Siena (**SIE**)

To Order, Specify:

For handle-(*exterior only*)

Handle No.: **F358 PLY**

Finish: **619**

For interior pack-(*shown below*)

Interior No.: **F359**

Design: **ACC**

Finish: **619**

*Handing: **LH**

*Required on lever designs
ACC, AVA & FLA (LH or RH)

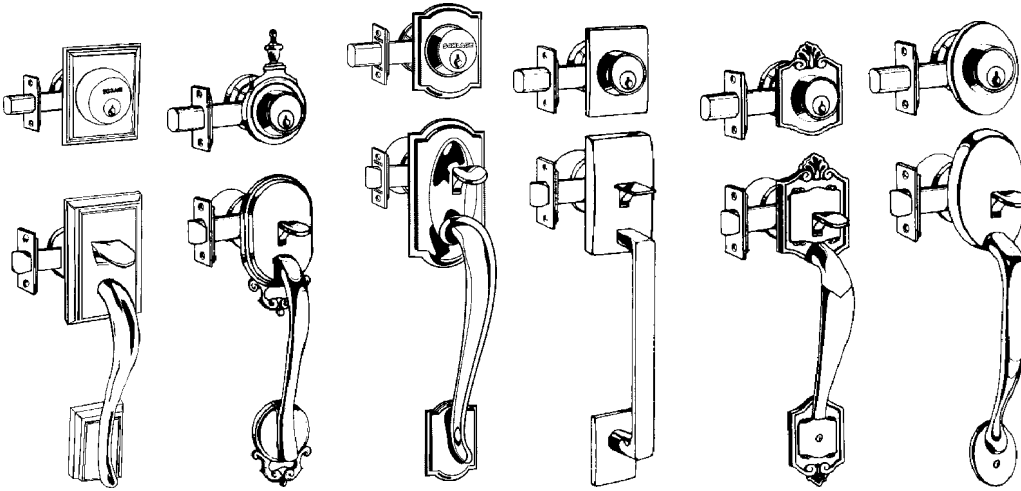

ADDISON

F358 ADD

F392 ADD

505, 605, 609, 613
619, 620, 716

BOWMAN

F358 BOW

F392 BOW

505, 605, 609

CAMELOT

F358 CAM

F392 CAM

505, 605, 609, 613
619, 620, 625, 716

CENTURY

F358 CEN

F392 CEN

505, 605, 625,
626

PARTHENON

F358 PAR

F392 PAR

609

PLYMOUTH

F358 PLY

F392 PLY

505, 605, 609, 613
619, 620, 625, 626, 716

FUNCTION

Locking Handle

Dummy Handle

•ALL HANDLES ARE SOLD LESS INTERIOR PACK (YOU MUST ORDER SEPARATELY)•

SPECIFICATIONS

DOOR THICK.: 1-5/8" to 2"
BACKSET: 3AL-Adjustable latch for 2-3/8", 2-3/4" with Square Face/Round Face/Drive-in.
STRIKE: RCS & SCS strike for bottom latch. Deadlock has square corner strike.
BORE: 1-1/2" or 2-1/8" for deadlock. 2-1/8" for handle.
SPACING: 4" center to center recommended.
DEADBOLT: B360, 1" throw.
KEY BLANK: 35-100-C 5-pin
KEYWAY: C Standard, 5-pin
FINISHES:
505 Bright Brass, ULTIMA™-Lifetime
605 (US-3) Bright Brass, clear coated
609 (US-5) Antique Brass, clear coated
613 (US-10B) Oil Rubbed Bronze-Artisan Lifetime
619 (US-15) Satin Nickel Plated-Artisan Lifetime
620 (US-15A) Antique Pewter-Artisan Lifetime
625 (US-26) Bright Chrome-Artisan Lifetime
626 (US-26D) Satin Chrome
716 New Aged Bronze

*613 is a living finish and will wear and change appearance overtime

Distance from center of handle hole to bottom mounting screw:

Addison:	8-3/8" to 9-7/8"	Bowman:	7-3/4"
Camelot:	9-11/16"	Century:	9"
Parthenon:	8-1/2"	Plymouth:	9-7/16"

INTERIOR DESIGNS



AVANTI (AVA)

605, 609, 613,
619, 620, 625, 716

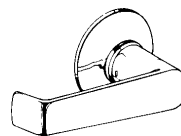

ELAN (ELA)

605, 626

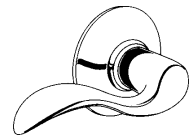

ACCENT (ACC)

605, 609, 613,
619, 620, 625, 716

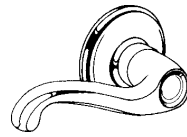

FLAIR (FLA)

605, 609, 613, 619, 620,
625, 626, 716

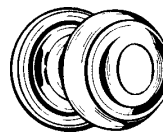

GEORGIAN (GEO)

605, 609, 619,
620, 625, 716

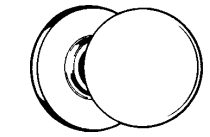

ORBIT (ORB)

605, 609, 613, 619,
620, 625, 626

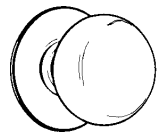

PLYMOUTH (PLY)

605, 613, 619,
620, 625, 626, 716

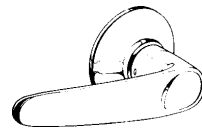

JAZZ (JAZ)

605, 619

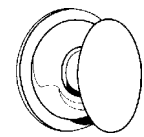

SIENA (SIE)

605, 609, 613, 619, 620, 625, 716

©ZIPF LOCK COMPANY

HANDLE PACK CONTAINS: Handle, deadbolt cylinder, screw for handle bottom and trim.

INTERIOR PACK CONTAINS: 1 knob/lever, 1 thumbturn for deadlock, strikes, cover trim and 2 latches.

185_{v1}
(PL-10)

SCHLAGE

10 locks per case

H SERIES

Interconnected Entrance Locks

- ANSI A156.12, 1992.
- U.L. Listed for 3-hour Fire Door.
- Panic-proof Exiting.
- 3-year Mechanical Warranty.
- 6-pin cylinders

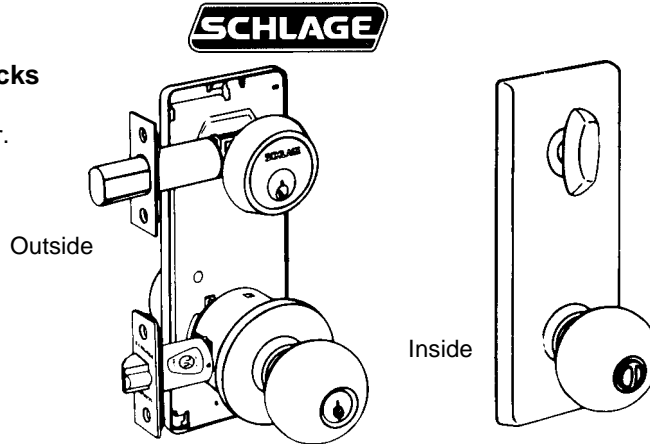

H110PASSAGE SET WITH 1" DEADBOLT (ANSI F95)

Entrance, Single Locking.

Deadbolt thrown or retracted by key in upper lock from outside or by inside turn unit. Bolt automatically deadlocks when fully thrown. Latchbolt retracted by knob/lever from either side. Inside knob/lever retracts deadbolt and latchbolt simultaneously for immediate exit.

Stock No.

- H110-6 LEV 626
- H110-6 ORB 605 or 626
- H110-6 PLY 605

H153KNOB LOCK WITH 1" DEADBOLT (ANSI F97)

Entrance, Double Locking.

Deadbolt thrown or retracted by key in upper lock from outside or by inside turn unit. Bolt automatically deadlocks when fully thrown. Deadlatch retracted by key in outer knob when locked by pushing turn-button in inner knob/lever. Outer knob may be fixed in locked position by rotating turn-button. Inside knob/lever retracts deadbolt and deadlatch simultaneously for immediate exit.

Stock No.

- *H153-6 ORB/LEV 626
- H153-6 ORB 605 or 626
- H153-6 PLY 605 or 626

*ORB knob outside/LEV lever inside

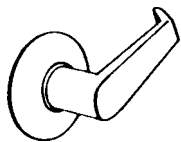

LEVON
(LEV)

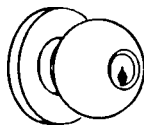

ORBIT
(ORB)



PLYMOUTH
(PLY)

SPECIFICATIONS

DOOR THICKNESS:	1-3/8" to 1-3/4"
BACKSET:	2-3/4" square face
BORE:	1-1/2" for deadlock 2-1/8" for knoblock
SPACING:	4" center to center
ESCUTCHEON:	2-3/4" x 6-15/16" x 5/32"
DEADBOLT:	B250 Series, 1" throw
LATCH THROW:	1/2"
CYLINDERS:	6-pin
FINISHES:	605 (US-3) Bright Brass, clear coated 609 (US-5) Antique Brass, clear coated 626 (US-26D) Satin Chrome

HOW TO DETERMINE THE HANDING OF A DOOR:

- The hand of a door is always determined by facing the OUTSIDE of a door.
- If the hinge is on the left side of the door, the door is left handed (LH).
- If the hinge is on the right side of the door, the door is right handed (RH).
- To determine the hand of a dummy lever, face the side of the door it will be used on. If hinges are on left, order L.H., if hinges are on right, order R.H.

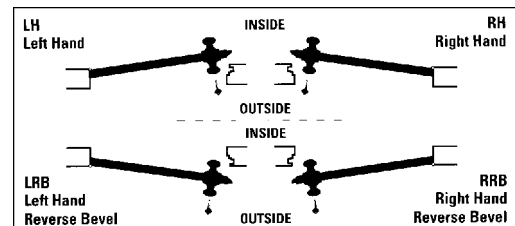

©ZIPF LOCK COMPANY

SCHLAGE

L SERIES

Heavy Duty Mortise Locks For Commercial and Institutional Doors

- ANSI A156.13, 1994, Series 1000, Grade 1 Operational, Grade 1 Security.
- U.L. Listed for up to 3-hour Fire Doors.
- Case Size: 4-7/16" x 6-1/16" x 1".
- Handing: Stock Right Hand (RH). Easily reversible.
- Sold less cylinder. Order separately.

SPECIFICATIONS

DOOR THICKNESS: 1-3/4".
BACKSET: 2-3/4"
DEADBOLT: 1" throw stainless steel.
LATCH THROW: 3/4" throw stainless steel, w/anti-friction tongue.
CYLINDER: L-Less Cylinder, Order separately. See Below.
CASE: 4-7/16" x 6-1/16" x 1"
ARMORED FRONT: 1-1/4" x 8"
FINISHES: 626 (US-26D) Satin Chrome

To Order, Specify:

Function: **SL-L9080L*** Storeroom
 Design: **06A** 06A Lever
 Finish: **626** Satin Chrome
 *Locks sold less cylinder. Order separately.

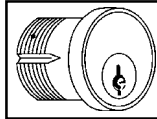

Cylinder Available-
Stock No. Description
 30-001-C 118 626 C Keyway
 30-001-E 118 626 E Keyway



6 locks per case

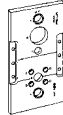
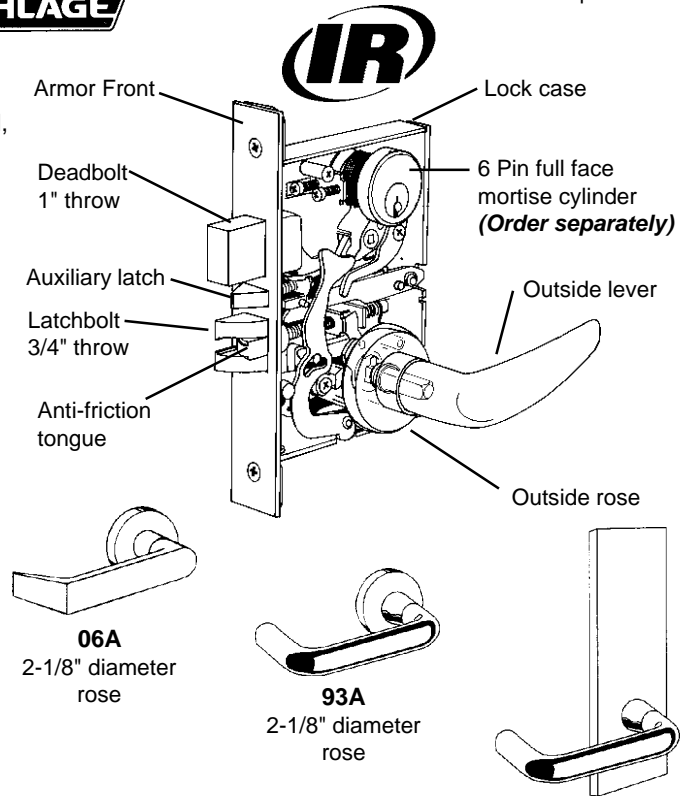

Need help with installation?
 We stock ProLok's Template kits.
 Ask about the PK-INCL, PK-IN50, PK-IN50R.

Need a mortise lock not listed?? Give us a call with your needs.

Function	No.	Operation	ANSI
SINGLE DUMMY TRIM	SL-L0170	Lever on one side fixed by mounting bar	
PASSAGE	SL-L9010	Latchbolt retracted by lever from either side at all times	F01
BED/BATH PRIVACY	SL-L9040	Latchbolt retracted by lever from either side unless outside is locked by inside turn piece. Turning inside lever or closing door unlocks outside lever. To unlock from outside, remove emergency button, insert emergency turn (furnished) in access hole and rotate.	F22
OFFICE & INNER ENTRY	SL-L9050L	Latchbolt retracted by lever from either side unless outside is made inoperative by key outside or by rotating inside thumbturn. When outside is locked, latchbolt is retracted by key outside or by lever inside. Outside lever remains locked until thumbturn is returned to vertical or unlocked by key. Auxiliary latch deadlocks latchbolt when door is closed.	F04
CLASSROOM	SL-L9070L	Latchbolt retracted by lever from either side unless outside is locked by key. Unlocked from outside by key. Inside lever always free for immediate exit. Auxiliary latch deadlocks latchbolt when door is closed.	F05
STOREROOM	SL-L9080L	Latchbolt retracted by key outside or lever inside. Outside lever always inoperative. Auxiliary latch deadlocks latchbolt when door is closed.	F07
ENTRANCE	SL-L9453L	Latchbolt retracted by lever from either side unless outside is locked by 20° rotation of thumbturn. Deadbolt thrown or retracted by 90° rotation of thumbturn. When locked, key outside or lever inside retracts deadbolt and latchbolt simultaneously. Outside lever remains locked until thumbturn is restored to vertical position. Throwing deadbolt automatically locks outside lever. Auxiliary latch deadlocks latchbolt when door is closed.	F20

©ZIPF LOCK COMPANY

SCHLAGE

Primus Security Cylinders

What is PRIMUS®??

Primus is a patented sidebar cylinder and key designed for key control, pick resistance and attack resistance. Primus is Schlage's highest security cylinder and is available in two families of keyways, Classic and Everest®. Classic Primus cylinders can be incorporated into most existing Classic key systems. Everest Primus can be incorporated into any Everest key system. Primus systems are more economical than most other high security cylinders because you don't have to install Primus cylinders on every door. You can have *conventional cylinders* in most locks, *Classic Primus Controlled Access* cylinders in the areas where positive key control and pick resistance are required and *Classic Primus UL Listed High Security* Cylinders where you need resistance to drilling and other physical attacks. Primus cylinders are available to retrofit most popular commercial locks by Corbin-Russwin, Sargent and Yale. This means that you don't have to buy new hardware to convert to Schlage's Primus key systems.

Classic Primus Level 1—Designed for small to medium size businesses.

Overview: Easy introduction to Classic Primus sales; Same side milling nationwide; No minimum initial order required; No sole source relationship with your distributor or customers. You are required to sign a Level 1 contract with each distributor from whom you purchase Level 1 products. In the contract you agree, among other things: To safeguard Classic Primus key blanks; Not to give, sell or lend key *blanks* to anyone under any circumstances; To sell directly to end users only; To issue a Level 1 ID card to each end user; To require ID card and signature before duplicating any Level 1 keys; To maintain accurate records of all keys.

Classic Primus Level 1+—Designed for small to medium size businesses.

Overview: Ties your end users to you for their Classic Primus Level 1+ keys; You are tied to your wholesaler for key blanks; Key blanks are stamped with your ID number; Wholesaler has its own side biting and selects which of its locksmiths will handle the product; Other locksmiths in your area may have the same side biting but are not authorized to cut keys with your ID number; Key blanks are drop shipped to you from Schlage and invoiced through your wholesaler; Level 1+ cylinders are shipped 0-bitted and all keying is done by the locksmith. You are required to sign a Level 1 Plus contract with your wholesaler and purchase the prevailing minimum dollar amount of inventory. In the contract you agree, among other things: Not to cut keys for any Classic Primus 1+ systems other than your own, as identified by the ID number on each key; To safeguard Classic Primus key blanks and ID cards; not to give, sell or lend key *blanks* to anyone under any circumstances; To sell directly to end users only; To require and validate a signature before duplicating any Level 1+ keys; To maintain accurate records of all keys cut.

Classic Primus Level 3 or 4—Higher restriction. For larger applications. Please give us a call.

Everest Primus Level 7—Designed for small to medium size businesses.

Overview: Ties all your end users to you for their Primus Level 7 keys; You are tied to your wholesaler for key blanks; Key blanks have your wholesaler's side biting and are stamped with *your* ID number by Schlage; Wholesaler has its own side biting and selects which of its locksmiths will handle the product; Other locksmiths in your area may have the same side biting; Key blanks are drop shipped to you from Schlage and invoiced through your wholesaler; Level 7 cylinders are shipped 0-bitted and all keying is done by the locksmith. You are required to sign a Level 7 contract with your wholesaler and purchase the prevailing minimum dollar amount of inventory. In the contract you agree, among other things: Not to cut keys for any Primus 7 systems other than your own, as identified by the ID number on each key; To safeguard Primus key blanks and ID cards; not to give, sell or lend key *blanks* to anyone under any circumstances; To sell directly to end users only; To require and validate a signature before duplicating any Level 7 keys; To maintain accurate records of all keys cut.

Everest Primus Level 9—Higher restriction. For larger applications. Please give us a call.

CLASSIC PRIMUS		Typical Applications	EVEREST PRIMUS		
LEVEL	Patent Protected through 2007		Patent Protected through 2014	LEVEL	
1	Commercially Exclusive Stocked by distributors and resold to end users via commercial locksmiths: All level 1 locksmiths have the same side bittings.	<ul style="list-style-type: none"> ▪ Strip Mall Shops ▪ Small Businesses ▪ Upscale Homes 	Considered Everest Open for Commercial Exclusivity		
1+	Wholesaler/Locksmith Exclusive Locksmiths resell wholesaler's side biting to end users; keys bear locksmith ID number.		<ul style="list-style-type: none"> ▪ Small Businesses ▪ Restaurants ▪ Doctor's Offices 	Wholesaler/Locksmith Exclusive Locksmiths resell wholesaler's side biting to end users; keys bear locksmith ID number.	7
2	Contract Hardware Dealer Exclusive We do not participate in this level.			Servicing Dealer Exclusive We do not participate in this level.	8
3	End User Exclusive Exclusivity is based on either random assignment or on the first 2 digits of the zip code, depending on end user commitment.		<ul style="list-style-type: none"> ▪ Educational Facilities ▪ Healthcare Facilities ▪ Large Office Complexes ▪ Government Buildings ▪ Detention Centers ▪ Franchises 	End User Exclusive Exclusivity is based on either random assignment or on the first 2 digits of the zip code, on time zone, or on a nationwide basis, depending on end user commitment.	9
4	End User Exclusive Exclusivity is based on either a time zone or nationwide basis, depending on end user commitment.				

©ZIPF LOCK COMPANY

SCHLAGE

LEVEL 1 - CLASSIC

Primus Security Cylinders



"Controlled Access" 20-700 Series. (20-500 High Security UL Listed—Factory order only)

<u>A-AL-D-ND-H Series - 6 Pin</u>	<u>C Keyway-1001</u>	<u>E Keyway-1006</u>	<u>Finish</u>
Multiple Tailpiece Cylinder(5 tailpieces)	SP-40-700-CP	SP-40-700-EP	606, 626
*A Series - 6 Pin	<u>C Keyway-1001</u>	<u>E Keyway-1006</u>	<u>Finish</u>
For Georgian, Plymouth, Tulip	*SP-20-724-CP	*SP-20-724-EP	606, 626
For Orbit	*SP-20-724-122-CP	*SP-20-724-122-EP	606, 626
*AL Series - 6 Pin	<u>C Keyway-1001</u>	<u>E Keyway-1006</u>	<u>Finish</u>
All Designs	*SP-20-728-CP	*SP-20-728-EP	606, 626
BC100 & B660 Series - 6 Pin	<u>C Keyway-1001</u>	<u>E Keyway-1006</u>	<u>Finish</u>
<i>Trim rings and driver bars not included</i>			
For BC100 Series	SP-20-729-CP	SP-20-729-EP	606, 626
For B660 (Fits 1-3/8" to 2-1/2" doors)	SP-20-744-CP	SP-20-744-EP	606, 626
For B662 (Fits 1-3/8" to 2" doors)	SP-20-745-CP	SP-20-745-EP	606, 626
*D Series - 6 Pin	<u>C Keyway-1001</u>	<u>E Keyway-1006</u>	<u>Finish</u>
For Knobs	*SP-20-748-CP	*SP-20-748-EP	606, 626
For Knobs, 2" to 2-1/2" doors	*SP-20-724-CP	*SP-20-724-EP	606, 626
For Levers "D"	*SP-20-750-CP	*SP-20-750-EP	606, 626
For Levers "ND"	*SP-20-765-CP	*SP-20-765-EP	606, 626
L Series Lockout-Outside Cylinder	<u>C Keyway-1001</u>	<u>E Keyway-1006</u>	<u>Finish</u>
1-1/8" length, no ring, for L9060	SP-20-715-CP	SP-20-715-EP	626
Mortise Cylinders - 6 Pin	<u>C Keyway-1001</u>	<u>E Keyway-1006</u>	<u>Finish</u>
A/R Cam, with 3/8" blocking ring and B220-050 set screw pack	SP-20-706-CP-118	—	613, 626
1-1/8" length			
Straight Cam, full face w/compression ring			
1-1/8" length	SP-20-700-CP-118	SP-20-700-EP-118	605, 612, 613, 626
1-1/4" length	SP-20-700-CP-114	SP-20-700-EP-114	605, 612, 613, 626
Rim Cylinder	<u>C Keyway-1001</u>	<u>E Keyway-1006</u>	
With Horizontal Bar (changeable)	SP-20-710-CP	SP-20-710-EP	605, 612, 613, 626
Key Blanks	<u>C Keyway-1001</u>	<u>E Keyway-1006</u>	
Primus Key Blank(side mill only)	SP-35-157-CP	SP-35-157-EP	Minimum of 10 blanks.
I. D. Cards	<u>C Keyway-1001</u>	<u>E Keyway-1006</u>	
Level One	SP-40-061-CP	SP-40-061-EP	
	Minimum of 5 cards.		

Cams pictured smaller than actual size.



Cam used on
20-700 cylinder
20-715 cylinder
SP-B502-948



Cam used on
20-706 cylinder
SP-B502-944

Need a cylinder not listed?? Just give us a call.

To Order, Specify: Catalog Number Keyway Number Finish

Ex: SP-20-724-CP 1001 606 = SP-20-724-CP 1001 606

1001 keyway tells us that you want Primus Level 1 "C" keyway.

©ZIPF LOCK COMPANY

**To be replaced by SP-40-700 Multiple Tailpiece cylinders*

SCHLAGE

LEVEL 1 PLUS - CLASSIC

Primus Security Cylinders



"Controlled Access" 20-700 Series. (20-500 High Security UL Listed—Factory order only)

<u>A-AL-D-ND-H Series - 6 Pin</u>	<u>C Keyway-1313</u>	<u>E Keyway-1318</u>	<u>Finish</u>
Multiple Tailpiece Cylinder(5 tailpieces)	SP-40-700-CP	SP-40-700-EP	606, 626
*A Series - 6 Pin	<u>C Keyway-1313</u>	<u>E Keyway-1318</u>	<u>Finish</u>
For Georgian, Plymouth, Tulip	*SP-20-724-CP	*SP-20-724-EP	606, 626
For Orbit	*SP-20-724-122-CP	*SP-20-724-122-EP	606, 626
*AL Series - 6 Pin	<u>C Keyway-1313</u>	<u>E Keyway-1318</u>	<u>Finish</u>
All Designs	*SP-20-728-CP	*SP-20-728-EP	606, 626
BC100 & B660 Series - 6 Pin	<u>C Keyway-1313</u>	<u>E Keyway-1318</u>	<u>Finish</u>
<i>Trim rings and driver bars not included</i>			
For BC100 Series	SP-20-729-CP	SP-20-729-EP	606, 626
For B660 (Fits 1-3/8" to 2-1/2" doors)	SP-20-744-CP	SP-20-744-EP	606, 626
For B662 (Fits 1-3/8" to 2" doors)	SP-20-745-CP	SP-20-745-EP	606, 626
*D Series - 6 Pin	<u>C Keyway-1313</u>	<u>E Keyway-1318</u>	<u>Finish</u>
For Knobs	*SP-20-748-CP	*SP-20-748-EP	606, 626
For Knobs, 2" to 2-1/2" doors	*SP-20-724-CP	*SP-20-724-EP	606, 626
For Levers "D"	*SP-20-750-CP	*SP-20-750-EP	606, 626
For Levers "ND"	*SP-20-765-CP	*SP-20-765-EP	606, 626
L Series Lockout-Outside Cylinder	<u>C Keyway-1313</u>	<u>E Keyway-1318</u>	<u>Finish</u>
1-1/8" length, no ring, for L9060	SP-20-715-CP	SP-20-715-EP	626
Mortise Cylinders - 6 Pin	<u>C Keyway-1313</u>	<u>E Keyway-1318</u>	<u>Finish</u>
A/R Cam, with 3/8" blocking ring and B220-050 set screw pack	SP-20-706-CP-118	—	613, 626
1-1/8" length			
Standard Cam, full face w/compression ring			
1-1/8" length	SP-20-700-CP-118	SP-20-700-EP-118	605, 612, 613, 626
1-1/4" length	SP-20-700-CP-114	SP-20-700-EP-114	605, 612, 613, 626
Rim Cylinder	<u>C Keyway-1313</u>	<u>E Keyway-1318</u>	
With Horizontal Bar (changeable)	SP-20-710-CP	SP-20-710-EP	605, 612, 613, 626
Key Blanks*	<u>C Keyway-1313</u>	<u>E Keyway-1318</u>	
Primus Key Blanks (side mill only)	SP-35-157-CP	SP-35-157-EP	Minimum of 50 blanks.
I. D. Cards*	<u>C Keyway-1313</u>	<u>E Keyway-1318</u>	
Level One Plus	SP-40-065-CP	SP-40-065-EP	Order in Multiples of 50.

*Key blanks and ID cards are special ordered from the factory and shipped to our customer.

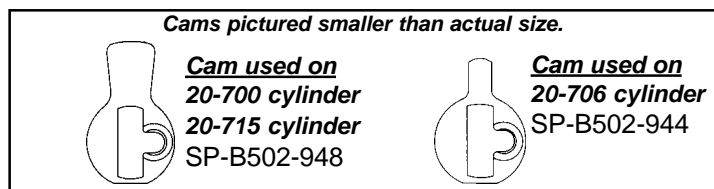

See next page for Primus Level 1 Plus Interchangeable Core, Padlocks and Primus cylinders for Corbin/Russwin, Sargent and Yale locks.

To Order, Specify: Catalog Number Keyway Number Finish

Ex: SP-20-724-CP 1313 606 = SP-20-724-CP 1313 606
 1313 keyway tells us that you want Primus Level 1 PLUS "C" keyway.

©ZIPF LOCK COMPANY

SCHLAGE

LEVEL 1 PLUS (Con't)

Primus Security Cylinders



For Corbin/Ruswin Locks

CK4200 and UT5200 Series
CL3400 and CL3600 Series

C Keyway-1313

SP-20-727-CP
SP-20-739-CP

E Keyway-1318*

SP-20-727-EP
SP-20-739-EP

Finish

626
626

For Sargent Locks

7L, 8L, 10 Line Levers
7, 8, 9 Line Knobs
6 Line (except B knob)

C Keyway-1313

SP-20-719-CP
SP-20-720-CP
SP-20-726-CP

E Keyway-1318*

SP-20-719-EP
SP-20-720-EP
SP-20-726-EP

Finish

626
626
626

For Yale Locks

5300, 5400, 6200 Series Knobs
5300LN, 5400LN Levers

C Keyway-1313

SP-20-723-CP
SP-20-747-CP

E Keyway-1318*

SP-20-723-EP
SP-20-747-EP

Finish

626
626

*E Keyway special order only.

Need the above cylinders in Level 1?? Just let us know, we can convert cylinders to level 1.

LEVEL 1 PLUS INTERCHANGEABLE CORE

"Controlled Access" 20-700 Series. (20-500 High Security UL Listed—Factory order only)

All Series

6 Pin Core only

C Keyway-1313

SP-20-740-CP

E Keyway-1318

SP-20-740-EP

Finish

606, 626

Mortise Cylinder w/core

Standard Cam, compression ring & spring
6 Pin unit, 1-1/2" length

C Keyway-1313

SP-20-763-CP

E Keyway-1318

SP-20-763-EP

Finish

605, 626

Rim Cylinder - Standard Rim w/core

With cylinder collar

C Keyway-1313

SP-20-757-CP

E Keyway-1318

SP-20-757-EP

605, 626

Padlock - (2" wide body) w/core

Shackle: 3/8" Dia.; 2" Vert.; 3/4" Hor.

C Keyway-1313

PL4742CP+

E Keyway-1318

PL4742EP+

452 Satin Brass

Key Blanks*

Primus Key Blanks (side mill only)
Primus Control Key (standard bow)
Primus Control Key (embossed 1 side)

C Keyway-1313

SP-35-157-CP
SP-35-158-CP
SP-35-052-CP

E Keyway-1318

SP-35-157-EP
SP-35-158-EP
SP-35-052-EP

Minimum of 50 blanks.
Minimum of 50 blanks.
Minimum of 50 blanks.

I. D. Cards*

Level One Plus

C Keyway-1313

SP-40-065-CP

E Keyway-1318

SP-40-065-EP

Order in Multiples of 50.

*Key blanks and ID cards are special ordered from the factory and shipped direct to our customers..

NOTE: Primus interchangeable cores require the use of a "universal" driver that will accept either standard or Primus cores. Existing locks may require changing the driver to accept Primus cores.

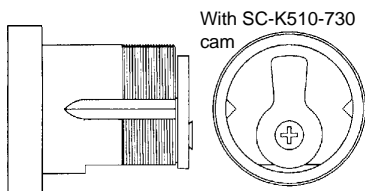

SP-20-763-XX (xx = keyway)
Mortise Cylinder: 1-1/2" long.
No blocking ring.

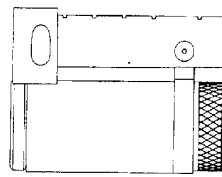

SP-20-740-XX (xx = keyway)
Core only.

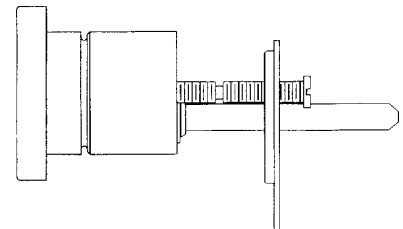

SP-20-757-XX (xx = keyway)
Rim Cylinder.

To Order, Specify: Catalog Number Keyway Number Finish

Ex: SP-20-727-CP 1313 606 = SP-20-727-CP 1313 606
1313 keyway tells us that you want Primus Level 1 PLUS "C" keyway.

©ZIPF LOCK COMPANY

SCHLAGE

LEVEL 7 - EVEREST PRIMUS

EVEREST



"Controlled Access" 20-700 Series. (20-500 High Security UL Listed—Factory order only)

<u>A-AL-D-ND-H Series - 6 Pin</u>	<u>C123 Keyway</u>	<u>C145 Keyway</u>	<u>Finish</u>
Multiple Tailpiece Cylinder(5 tailpieces)	SP-40-700-C123	SP-40-700-C145	606, 626
*A Series - 6 Pin	C123 Keyway	C145 Keyway	Finish
For Georgian, Plymouth, Tulip	*SP-20-724-C123	*SP-20-724-C145	606, 626
For Orbit	*SP-20-724-122-C123	*SP-20-724-122-C145	606, 626
*AL Series - 6 Pin	C123 Keyway	C145 Keyway	Finish
All Designs	*SP-20-728-C123	*SP-20-728-C145	606, 626
BC100 & B660 Series - 6 Pin	C123 Keyway	C145 Keyway	Finish
<i>Trim rings and driver bars not included</i>			
For BC100 Series	SP-20-729-C123	SP-20-729-C145	606, 626
For B660 (Fits 1-3/8" to 2-1/2" doors)	SP-20-744-C123	SP-20-744-C145	606, 626
For B662 (Fits 1-3/8" to 2" doors)	SP-20-745-C123	SP-20-745-C145	606, 626
*D Series - 6 Pin	C123 Keyway	C145 Keyway	Finish
For Knobs	*SP-20-748-C123	*SP-20-748-C145	606, 626
For Knobs, 2" to 2-1/2" doors	*SP-20-724-C123	*SP-20-724-C145	606, 626
For Levers "D"	*SP-20-750-C123	*SP-20-750-C145	606, 626
For Levers "ND"	*SP-20-765-C123	*SP-20-765-C145	606, 626
L Series Lockout-Outside Cylinder	C123 Keyway	C145 Keyway	Finish
w/compression ring & spring			
1-1/8" length, for L9060	SP-20-715-C123	SP-20-715-C145	626
Mortise Cylinders - 6 Pin	C123 Keyway	C145 Keyway	Finish
A/R Cam, with 3/8" blocking ring and B220-050 set screw pack	SP-20-706-118-C123	SP-20-706-118-C145	613, 626
1-1/8" length			
Standard Cam, full face w/compression ring			
1-1/8" length	SP-20-700-118-C123	SP-20-700-118-C145	605, 612, 613, 626
1-1/4" length	SP-20-700-114-C123	SP-20-700-114-C145	605, 612, 613, 626
Rim Cylinder	C123 Keyway	C145 Keyway	
With Horizontal Bar (changeable)	SP-20-710-C123	SP-20-710-C145	605, 612, 613, 626
Key Blanks*	C123 Keyway	C145 Keyway	
Primus Key Blanks (side mill only)	SP-35-004-C123	SP-35-004-C145	Minimum of 50 blanks.
I. D. Cards*	C123 Keyway	C145 Keyway	
Level Seven	SP-40-060-C123	SP-40-060-C145	Order in Multiples of 50.

***Key blanks and ID cards are special ordered from the factory and shipped direct to our customers.**

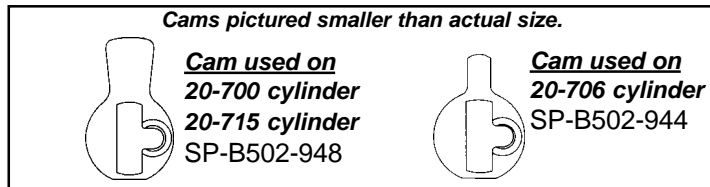

See next page for Everest Primus Level 7 Interchangeable Core, Padlocks and Primus cylinders for Corbin/Ruswin, Sargent and Yale locks.

To Order, Specify: Catalog Number Keyway Number Finish

Ex: SP-20-724- C123 606 = SP-20-724-C123 606

©ZIPF LOCK COMPANY

SCHLAGE

LEVEL 7 (Con't)

EVEREST



For Corbin/Russwin Locks

CK4200 and UT5200 Series
CL3400 and CL3600 Series

C123 Keyway

SP-20-727-C123
SP-20-739-C123

C145 Keyway

SP-20-727-C145
SP-20-739-C145

Finish

626
626

For Sargent Locks

7L, 8L, 10 Line Levers
7, 8, 9 Line Knobs
6 Line (except B knob)

C123 Keyway

SP-20-719-C123
SP-20-720-C123
SP-20-726-C123

C145 Keyway

SP-20-719-C145
SP-20-720-C145
SP-20-726-C145

Finish

626
626
626

For Yale Locks

5300, 5400, 6200 Series Knobs
5300LN, 5400LN Levers

C123 Keyway

SP-20-723-C123
SP-20-747-C123

C145 Keyway

SP-20-723-C145
SP-20-747-C145

Finish

626
626

LEVEL 7 FULL SIZE INTERCHANGEABLE CORE - SEE NEXT PAGE FOR SMALL FORMAT EVEREST-B

"Controlled Access" 20-700 Series. (20-500 High Security UL Listed—Factory order only)

All Series

6 Pin Core only

C123 Keyway

SP-20-740-C123

C145 Keyway

SP-20-740-C145

Finish

606, 626

Mortise Cylinder w/core

Standard Cam, compression ring & spring
6 Pin unit, 1-1/2" length

C123 Keyway

SP-20-763-C123

C145 Keyway

SP-20-763-C145

Finish

605, 613*, 626

*1313 Kwy only

Rim Cylinder - Standard Rim w/core

With cylinder collar

C123 Keyway

SP-20-757-C123

C145 Keyway

SP-20-757-C145

605, 613*, 626

Padlock - (2" wide body) w/core

Shackle: 3/8" Dia.; 2" Vert.; 3/4" Hor.

C123 Keyway

\$PL4742-C123

C145 Keyway

\$PL4742-C145

452 Satin Brass

Key Blanks*

Primus Key Blanks (side mill only)
Primus Control Key (embossed 1 side)

C123 Keyway

SP-35-004-C123
SP-35-005-C123

C145 Keyway

SP-35-004-C145
SP-35-005-C145

Minimum of 50 blanks.
Minimum of 50 blanks.

I. D. Cards*

Level 7

C123 Keyway

SP-40-060-C123

C145 Keyway

SP-40-060-C145

Order in Multiples of 50.

*Key blanks and ID cards are special ordered from the factory and shipped direct to our customers.

\$=Padlocks are discontinued. Call for closeout prices.

NOTE: Primus interchangeable cores require the use of a "universal" driver that will accept either standard or Primus cores. Existing locks may require changing the driver to accept Primus cores.

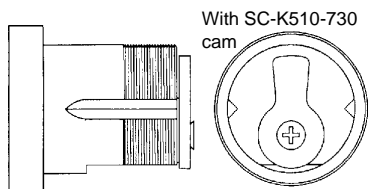

SP-20-763-Cxxx (xxx = keyway)
Mortise Cylinder: 1-1/2" long.
No blocking ring.

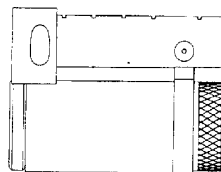

SP-20-740-Cxxx (xxx = keyway)
Core only.

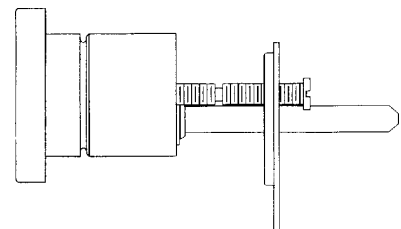

SP-20-757-Cxxx (xxx = keyway)
Rim Cylinder.

To Order, Specify: Catalog Number Keyway Number Finish

Ex: SP-20-727- C123 606 = SP-20-727-C123 606

©ZIPF LOCK COMPANY

SCHLAGE

EVEREST B - SMALL FORMAT (BEST® STYLE) INTERCHANGEABLE CORE CYLINDERS (SFIC)

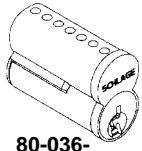

80-036-

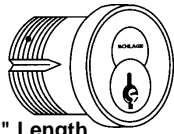

1-3/8" Length

80-102 Straight Cam

80-103 A/R MS Cam

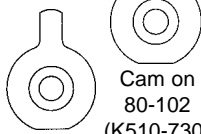

Cam on
80-103

(K510-711)



Cam on
80-102

(K510-730)

Stock No.

Description

80-036-B235-626	Core Only- RESTRICTED*
80-102-626	Mortise Cylinder Housing-Less Core.
80-103-626	Mortise Cylinder Housing-Less Core.
80-129-626	Rim Cylinder-Less Core(Not Pictured)
35-401	KeyBlank(Control & Operating)- Restricted*

*ALL Everest SFIC (Everest B Family) keyways are restricted. Call for details.

PRIMUS MISCELLANEOUS PARTS

Cylinder Bars & Drivers

Stock No.

(Must use Primus driver, cap pin location at 2 o'clock rather than 10 o'clock.)

A & H-Series Knobs - Everest & Primus

Bar & Driver, Standard	SP-A301-337*
Bar & Driver, ORB (Except A73)	SP-A301-338

*Requires use of disc C603-098

AL-Series Levers

Bar & Driver, Standard (Except AL85)	SC-A700-031
--------------------------------------	--------------------

BC100 Series Deadbolts - 6 Pin

Driver (Everest & Primus)	SP-B502-949
Tailpiece, BC160	SC-B202-557
Tailpiece, BC162	SC-B202-269

B660 Series Deadbolts - 6 Pin - Everest & Primus

B660/663 (1-3/8" to 2-1/2")	SP-B610-084
B662 (1-3/8 to 2")	SP-B610-085

D-Series (Not D85)

Bar & Driver, Knobs, Standard	SC-C603-524
Bar & Driver, Knobs (2" to 2-1/2")	SP-A301-337*
Bar & Driver, Levers	SC-C604-243
Bar & Driver, "ND" Levers	SP-N523-022
Full Size I/C core driver & retainer	SC-04-033

* Requires use of disc C603-098

Rim Cylinder

Driver, Standard (non-IC)	SC-B502-310
Tailpiece, standard (non-IC)	SC-B502-899

Miscellaneous Primus

Stock No.

Finger Pin Kit(fingerpins, springs, 40-066)	SC-40-070
Key Gage	SC-40-104
Key Order Form	SP-MS-E110
Facesheet	SP-MS-E120
Signature Card	SP-MS-E130
ID Control Register	SP-MS-E160

Pins and Springs (min of 10)

Stock No.

#1 Finger Pin	SP-34-001
#2 Finger Pin	SP-34-002
#3 Finger Pin	SP-34-003
#4 Finger Pin	SP-34-004
#6 Finger Pin	SP-34-006

Top, Master & Bottom pins can be used on Primus & Everest Primus "Controlled Access" and Schlage Standard & Everest Cylinders.

*LAB Stock No.

#1 Top Pin	34-101	LB-SC-34-101
#2 Top Pin	34-102	LB-SC-34-102
#3 Top Pin	34-103	LB-SC-34-103
#2 Master Pin	34-202	LB-SC-34-202
#3 Master Pin	34-203	LB-SC-34-203
#4 Master Pin	34-204	LB-SC-34-204
#5 Master Pin	34-205	LB-SC-34-205
#6 Master Pin	34-206	LB-SC-34-206
#7 Master Pin	34-207	LB-SC-34-207
#8 Master Pin	34-208	LB-SC-34-208
#9 Master Pin	34-209	LB-SC-34-209
#0 Bottom Pin	34-300	LB-SC-34-300
#1 Bottom Pin	34-301	LB-SC-34-301
#2 Bottom Pin	34-302	LB-SC-34-302
#3 Bottom Pin	34-303	LB-SC-34-303
#4 Bottom Pin	34-304	LB-SC-34-304
#5 Bottom Pin	34-305	LB-SC-34-305
#6 Bottom Pin	34-306	LB-SC-34-306
#7 Bottom Pin	34-307	LB-SC-34-307
#8 Bottom Pin	34-308	LB-SC-34-308
#9 Bottom Pin	34-309	LB-SC-34-309

*LAB "Original Pins for Schlage". Sold in plastic Vials.

Pin Tumbler Spring	LB-SPR-115L
Cap Retainer Pin Spring	LB-SC-C503-115
Finger Pin Spring	SP-C603-951
Everest Check Pin Spring	SP-C603-951
Sidebar Spring	SP-C603-952
SFIC 20S Tumbler Spring	SC-C504-114
Full Size I/C Control Bottom Pin	SC-C603-967
Retainer Cap Pin	LB-SC-C503-116
Retainer Cap	SC-C503-118
Sidebar	SP-C603-950
Cylinder Plug Holder	SP-40-066

Mortise Cylinder Cams

Stock No.

Cam Screw	SP-B502-942
A/R MS Series Cam	SP-B502-944
A/R 4070 Series Cam	SP-B502-945
Standard Mortise Cam	SP-B502-948
L Series Cam	SP-L583-153
Arrow 004, Yale 2160	SP-B520-329
Corbin Russwin ML2200 (not 2255/2242)	SP-B520-309
Corbin Russwin DL4000 Series	SP-B520-366
Corbin Russwin A65 (pre1993)	SP-B520-367
Sargent 13-0660 (not 16/in or 50/out)	SP-B520-329

—Cams pictured on page 200-201—

SCHLAGE

COMMERCIAL LATCHES

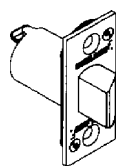

ZL-471



ZL-41A

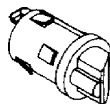

ZL-194

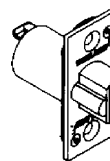

ZL-47

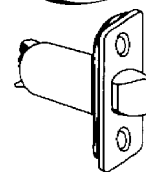

ZL-124

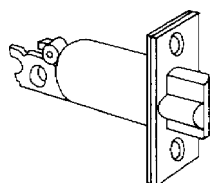

ZL-67

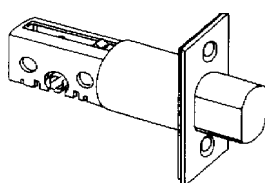

ZL-521

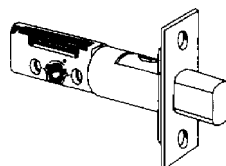

ZL-600

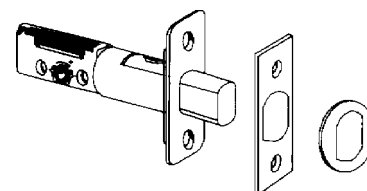

ZL-601

SCHLAGE-COMMERCIAL	2-3/8" Square Face	2-3/8" D.I.	2-3/4" Square Face	2-3/4" D.I.
A Latch	ZL-471 (11-068)	ZL-473 (11-110)	ZL-472N (11-111)	ZL-474 (11-113)
A Latch (Round Corner)	ZL-471RC (11-069)			
A Latch (1-1/8" Face)			ZL-472 (11-116)	
A Deadlatch	ZL-47 (11-085)	ZL-194 (11-104)	ZL-123N (11-091)	ZL-237 (11-105)
A Deadlatch (Round Corner)	ZL-47RC (11-088)			
A Deadlatch (1-1/8" Face)			ZL-123 (11-096)	
A Deadlatch 3-3/4" Backset	ZL-347 (11-103) 3-3/4" square face deadlatch for A Series			
A Series 5" Link (Use with 2-3/8")	ZL-41A (41-005) 5" link, for use with 2-3/8" latch/deadlatch			
B Deadlatch (B250)	ZL-67 (12-100)		ZL-176 (12-103)	
B Deadbolt (B600)	ZL-520 (12-630)	ZL-522 (12-640)	ZL-521 (12-631)	ZL-523 (12-641)
BC Deadbolt (BC100) Adjustable	ZL-600 (12-274)	ZL-602 (12-268)	ZL-600 (12-274)	ZL-602 (12-268)
BC Deadbolt (BC100) Triple-3AL	ZL-601 (12-270) Triple Option (3AL) - Has square, round corner faces & Drive-in			
D Latch (Knob & Old Lever)			ZL-124 (14-001)	
D Deadlatch (Knob & Old Lever)	ZL-506 (14-047)		ZL-125 (14-019)	
ND Latch (New Lever)			ZL-609 (13-048)	
ND Deadlatch (New Lever)	ZL-506 (14-047)		ZL-610 (13-047)	
D Deadlatch 3-3/4" Backset	ZL-338 (14-028) 3-3/4" square face deadlatch for D Series			
D Series 5" Link (Use with 2-3/4")	ZL-41D (43-005) 5" link, for use with 2-3/4" latch/deadlatch			
H Adjustable Deadbolt (H110/153)	ZL-600 (12-274)	ZL-602 (12-268)	ZL-600 (12-274)	ZL-602 (12-268)
H Latch (H110)	ZL-471 (11-068)	ZL-473 (11-110)	ZL-472N (11-111)	ZL-474 (11-113)
H Deadlatch (H153)	ZL-47 (11-085)	ZL-194 (11-104)	ZL-123N (11-091)	ZL-237 (11-105)

• More latches on next page •

©ZIPF LOCK COMPANY

SCHLAGE

RESIDENTIAL LATCHES

SCHLAGE

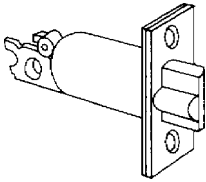

ZL-67

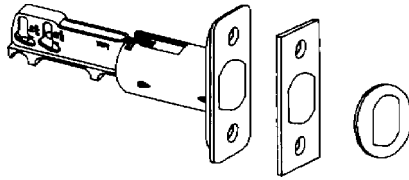

ZL-576

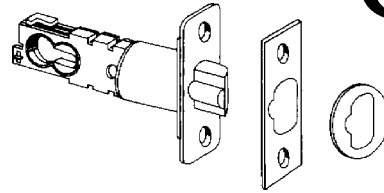

ZL-575

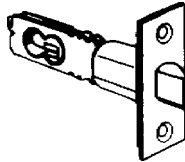

ZL-400

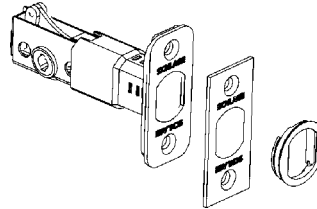

ZL-580

SCHLAGE-RESIDENTIAL	2-3/8" Square Face	2-3/8" D.I.	2-3/4" Square Face	2-3/4" D.I.
B Deadlatch (B250)	ZL-67 (12-100)		ZL-176 (12-103)	
**B Deadbolt (B100) Adjustable	ZL-469* (12-237)		ZL-469* (12-237)	
B Deadbolt (B360) Triple-3AL	ZL-576 (12-300) Triple Option (3AL) - Has square, round corner faces & Drive-in			
BR Deadbolt (BR260) Triple-3AL	ZL-580 (12-634) Triple Option (3AL) - Has square, round corner faces & Drive-in			
**F Latch (Adjustable)	ZL-400 (16-200)	ZL-401 (16-202)	ZL-400 (16-200)	ZL-401 (16-202)
F Latch (Adjust. Round Corner)	ZL-400RC (16-201)		ZL-400RC (16-201)	
F Latch Triple-3AL	ZL-574 (16-210) Triple Option (3AL) - Has square, round corner faces & Drive-in			
**F Deadlatch (Adjustable)	ZL-402 (16-206)		ZL-402 (16-206)	
F Deadlatch 5" Backset	ZL-508 (16-126) 5" square face deadlatch for F Series			
F Deadlatch Triple-3AL	ZL-575 (16-211) Triple Option (3AL) - Has square, round corner faces & Drive-in			
**MD Passage Latch	ZL-475 † (12-250)		ZL-476 † (12-251)	
**MD Privacy Latch	ZL-477 † (12-252)		ZL-478 † (12-253)	

† **Less Faceplate.** Faceplate Stock No. **SC-B520-322.** Specify Finish: 605 or 626.

*Adjustable deadbolt. **DISCONTINUED-Limited Supply.**

****DISCONTINUED-Limited Supply. CALL FOR CLOSEOUT PRICES.**

SCHLAGE

STRIKES



SC-10-001
605, 612, 613, 626
Standard Strike
SIZE: 2-3/4" x 1-1/8" x 3/32"

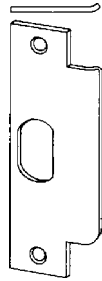

SC-10-025
605, 612, 613, 626
Strike for ANSI preparation
SIZE: 4-7/8" x 1-1/4" x 3/32"

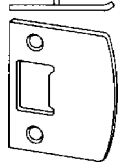

SC-10-026
605, 626
Full Lip Standard Strike

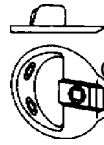

SC-10-058
605
Circular, adjustable
1-3/4" diameter
deadlatch strike

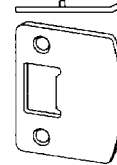

SC-10-027
605, 626
1/4" Radius Rounded
Corner Full Lip Strike

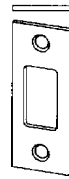

SC-10-094
605, 626
BC160, B360, BR260
Standard Strike
Square Corner

KEY BLANKS

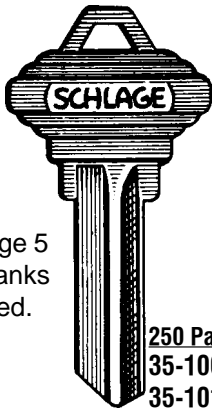

Schlage 5
pin blanks
pictured.

250 Packs
35-100C 250PK
35-101C 250PK

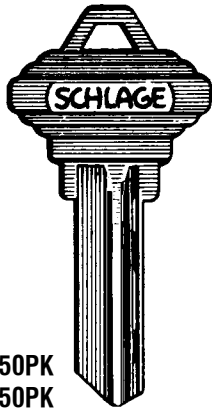

250 Packs
35-101E 250PK

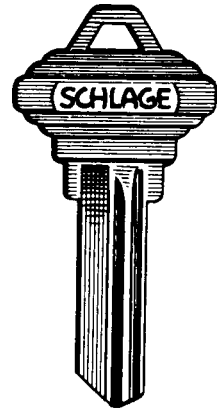
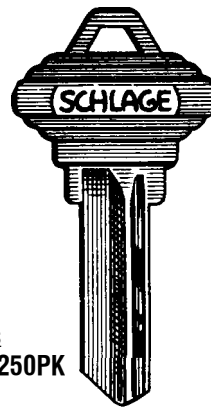
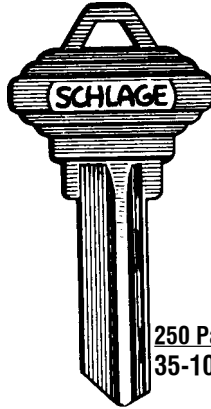

5 pin 35-100C
6 pin 35-101C

35-100CE
35-101CE

35-100E
35-101E

35-100EF
35-101EF

35-100F
35-101F

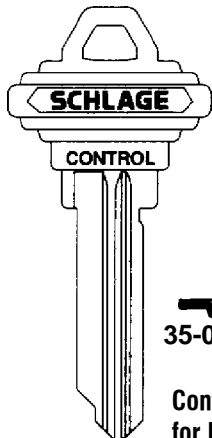

35-056-E

35-056-C
Control Key
for I/C core

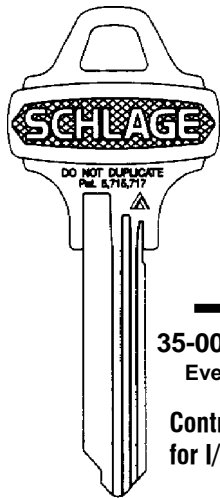

35-003-C145
Everest C

35-003-C123
Everest C
Control Key
for I/C core

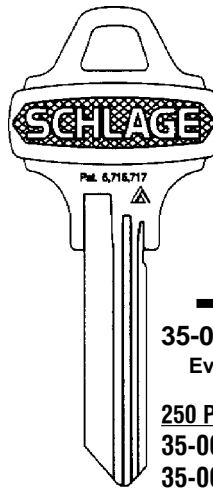

35-009-C145
Everest C

35-009-C123
Everest C
250 Packs
35-009-C123 250PK
35-009-C145 250PK

For ACCENTS Series
35-025-C
5 Pin
(not pictured)

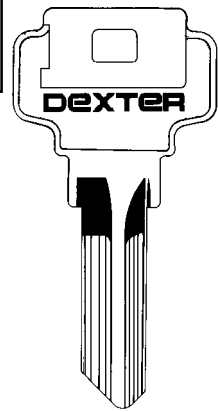

7750-000
7750-000 250PK
For Dexter J Series

We stock many PRIMUS® and EVEREST/PRIMUS® key blanks. Give us a call with your needs.
See pages 188-193 for details.

197^{v1}
(PL-10)

SCHLAGE

STANDARD CYLINDERS



See pages 188-193 for Primus and Everest-Primus Cylinders

Reduce Cylinder Inventory—

Multiple tailpiece cylinders allow high inventory flexibility with low investment. Included with each cylinder are tailpieces to suit these locks:

A Series (all designs)

AL Series

D Series Knobs

D Series Levers

ND Series Levers*

H Series (all designs)

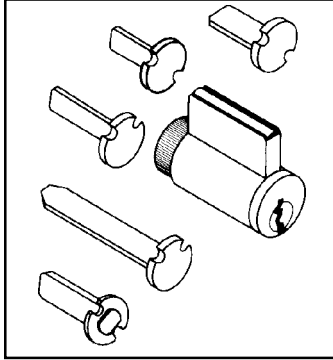

All cylinders are furnished 0-bitted.

All cylinders are furnished with 2 key blanks.

*40-100- Rolling change: Tailpiece for the New ND Series Lever is being added by the factory.

MULTIPLE TAILPIECE KNOB CYLINDERS

<u>Stock No.</u>	<u>Description</u>
40-100-C	Classic C Keyway
40-100-C123	Everest C123 Keyway
40-100-C145	Everest C145 Keyway
40-100-E	Classic E Keyway
40-100-F	Classic F Keyway

FINISHES: **606** Satin Brass
626 Satin Chrome

TO ORDER: Specify Stock No. and Finish.

SCHLAGE KNOB CYLINDERS FOR USE IN OTHER MANUFACTURERS' LOCKS

For Corbin/Ruswin Locks
CK4200 and UT5200 Series
CL3400 and CL3600 Series

Stock No.
24-127-x
24-139-x

For Yale Locks
5300, 5400, 6200 Series Knobs
5300LN, 5400LN Levers

Stock No.
24-123-x
24-147-x

For Sargent Locks
7L, 8L, 10 Line Levers
7, 8, 9 Line Knobs
6 Line-except B Knob

Stock No.
24-119-x
24-120-x
24-126-x

x = Keyway: C or E.
FINISHES: **606** Satin Brass
626 Satin Chrome
TO ORDER: Specify Stock No., Keyway and Finish.

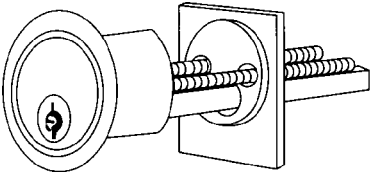

RIM CYLINDERS

<u>Stock No.</u>	<u>Finish</u>
20-022-C	605, 612, 613, 626
20-022-C123	605, 613, 626
20-022-C145	605, 613, 626
20-022-E	605, 613, 626
20-022-F	605, 626

FINISHES: **605** Bright Brass
612 Satin Bronze
613 Oil Rubbed Bronze
626 Satin Chrome

TO ORDER: Specify Stock No. and Finish.

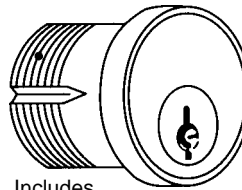

Includes
Compression
Ring and Spring

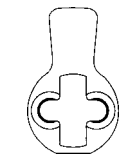

SC-B502-191

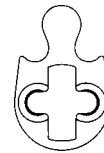

SC-L583-254

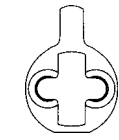

SC-B502-292

MORTISE CYLINDERS

<u>Stock No.</u>	<u>Length</u>	<u>Finish</u>	<u>Standard Cam</u>
20-001-x	1-1/8"	605, 612, 613, 626	SC-B502-191
20-001-x	1-1/4"	605, 626	SC-B502-191
20-013-x	1-1/8"	613, 626	SC-B502-292
30-001-x	1-1/8"	626	SC-L583-254
30-001-x	1-1/4"	626	SC-L583-254

20-013 includes B220-050 set screw pack for Adams Rite.

x = Keyway: C, C123, C145, E, or F. 30-001 only C123 & C145.

FINISHES: **605** Bright Brass **613** Oil Rubbed Bronze
612 Satin Bronze **626** Satin Chrome

TO ORDER: Specify Stock No., Keyway, Finish and Length.

Rim & Mortise cylinders with the C123 & C145 keyway are 0-bitted

SCHLAGE

STANDARD CYLINDERS

S & S200 SERIES LEVERS

Requires sleeve SC-S605-192

For S Series

21-028-x

x = Keyway: C, C123, C145, or E

Finish
606

BC100 SERIES - 6 PIN

Trim rings and driver bars not included

For BC100 Series

22-002-C123

Finish
606, 626

22-002-C145

606, 626

B660 SERIES - 6 PIN

For B660 (Fits 1-3/8" to 2-1/2" doors)

22-644-C123

Finish
606, 626

22-644-C145

606, 626

For B662 (Fits 1-3/8" to 2" doors)

22-645-C123

Finish
606, 626

22-645-C145

606, 626

For C, E, F keyways order 40-100- cylinder (page 199) and appropriate tailpiece (page 203)



SMALL FORMAT (BEST® STYLE) INTERCHANGEABLE CORE HOUSINGS (SFIC)

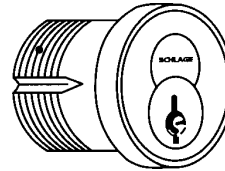

Core not included.



Cam on 80-103 (K510-711)



Cam on 80-102 (K510-730)

1-3/8" Length

80-102 Straight Cam
80-103 A/R MS Cam

Stock No.

Description

80-102-626 Mortise Cylinder Housing-Less Core.
80-103-626 Mortise Cylinder Housing-Less Core.
80-129-626 Rim Cylinder-Less Core (**Not Pictured**)

Need Best® Style cores?? Just let us know.

Need your I/C cores keyed?? Just let us know when ordering.

FULL SIZE INTERCHANGEABLE CORE CYLINDERS

Includes Core.

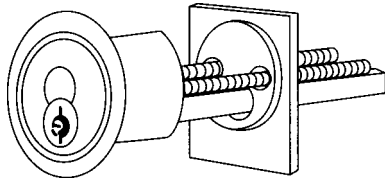

Includes: Compression Ring, Spring and 3/8" Blocking Ring.

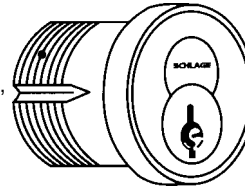

RIM CYLINDERS

With Core—

Stock No. **Finish**

***20-057-x** 606, 613, 626

*Made up from 20-079 & 23-030.

x = Keyway-see cores below right.

Less core—

Stock No. **Finish**

20-079 606, 613, 626

FINISHES: **606** Satin Brass
613 Oil Rubbed Bronze (Housing only)
626 Satin Chrome

TO ORDER: Specify Stock No. and Finish.

MORTISE CYLINDERS

Stock No.	Length	Finish	Core	Standard Cam
26-094	1-1/2"	606, 613, 626	Less Core	SC-K510-730
*20-061-x	1-1/2"	606, 613, 626	With Core	SC-K510-730

*Made up from 26-094 & 23-030, x = Keyway-see below.

FINISHES: **606** Satin Brass
613 Oil Rubbed Bronze (Housing only)
626 Satin Chrome

TO ORDER: Specify Stock No., Keyway, Finish and Length.

INTERCHANGEABLE CORES

Stock No.	Finish
23-030-C	606, 626
23-030-C123	606, 626
23-030-C145	606, 626
23-030-E	606, 626

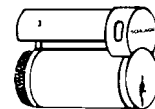

FINISHES: **606** Satin Brass
626 Satin Chrome

TO ORDER: Specify Stock No. and Finish.

SEE PAGE 197 FOR INTERCHANGEABLE CORE CONTROL KEY BLANKS

ALL Interchangeable cores are stocked 1-bitted.

SCHLAGE

PADLOCKS — STANDARD AND INTERCHANGEABLE CORE

1-3/4" Wide Body, Standard 6-Pin C or E Keyway

Stock No.	"A"	"B"	"C"
PL1001KD	5/16"	1-1/8"	3/4"
PL1002KD	5/16"	2"	3/4"
PL1003KD	5/16"	3"	3/4"

Keyway: C or E.

2" Wide Body, Schlage Full Size Interchangeable Core

Stock No.	"A"	"B"	"C"
PL4002	3/8"	2"	3/4"

Keyway: C or E.

2" Wide Body, Primus Full Size Interchangeable Core

Stock No.	"A"	"B"	"C"	Discontinued-
PL4742	3/8"	2"	3/4"	Call for closeout prices

Keyway: CP+(1313), EP+(1318), C123 or C145.

TO ORDER: Specify Stock No. and Keyway.

Rolling change on padlocks. The name will be changing from Schlage to Kryptonite per Schlage.

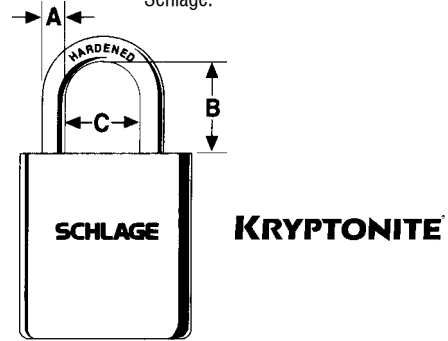

452-Satin Brass Finish

PL1000 Series furnished 6-pin keyed 5-pin. Key Different.

PL4002 furnished 1-bitted with two 6-pin keys. Control keys must be ordered separately.

PL4742 furnished 0-bitted less keys. Control keys must be ordered separately.

SPECIAL CAMS

Note-Cams pictured smaller than actual size.

SPECIAL CAMS FOR SCHLAGE MORTISE CYLINDERS TO OPERATE OTHER MANUFACTURERS' LOCKS

	Classic Conventional 20-001	Interchangeable Core 20-061, 20-771, 26-090 80-102, 80-132, 80-302	Everest & Primus 20-001 Everest 20-500 & 20-700 Primus
Corbin/Russwin® DL4000 Series. (Old Corbin 420 & Russwin 1503)	SC-B520-295 	SC-B520-254 	SP-B520-366
Corbin/Russwin® ML2200 Series. All functions except ML2255 & ML2242 inside.	SC-B520-233 	SC-B520-253 	SP-B520-309
Corbin/Russwin® A65 ML2200 master ring deadbolt functions manufactured before 6/10/93 Russwin Old cast iron residential locks	SC-B520-223 	SC-B520-360 	SP-B520-367
Sargent® 13-0660. All functions except 16 inside and 50 outside. Yale®-2160 Arrow®-#004	SC-B520-256 	SC-B520-296 	SP-B520-329

©ZIPF LOCK COMPANY

200_{v1}
(PL-10)

SCHLAGE

SPECIAL CAMS

Cams pictured smaller than actual size.

CAMS FOR COMPETITORS' CYLINDERS IN SCHLAGE LOCKS

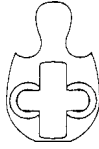

SC-L583-197
For: Sargent and Yale non-IC

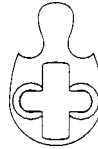

SC-L583-198
For: Corbin/Russwin non-IC

STANDARD & I/C CAMS

Cams pictured smaller than actual size.



SC-B502-191

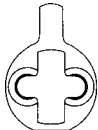

SC-B502-292



SC-B502-380

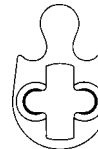

SC-L583-254



SC-B520-378



SC-L583-255

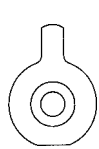

SC-K510-711



SC-K510-730

MORTISE CYLINDER CAMS/PARTS

<u>Stock No.</u>	<u>Description (Most Pictured above)</u>
SC-B502-468	Mortise Cylinder Classic conventional cam screw up to 1-3/8".
SC-B502-191	Mortise Cylinder-Classic conventional standard cam.
SC-B502-292	Mortise Cylinder-Classic conventional cam for Adams Rite MS
SC-B502-380	Mortise Cylinder-Classic conventional cam for Adams Rite 4070 series.
SC-L583-254	Mortise Cylinder-L Series classic conventional cam.
SC-K510-474	Friction washer for Full Size Interchangeable core Mortise housing.
SC-B520-378	SFIC & Full Size Interchangeable Core cam for Adams Rite 4070 series.
SC-L583-255	Mortise Cylinder-L Series SFIC & Full Size Interchangeable Core cam (except L9060 outside).
SC-K510-711	Mortise Cylinder-SFIC & Full Size Interchangeable Core cam for Adams Rite MS..
SC-K510-730	Mortise Cylinder-Straight Cam for SFIC & Full Size Interchangeable core.

PRIMUS CAMS

Cams pictured smaller than actual size.

<u>Stock No.</u>	<u>Description</u>
SP-B502-942	Cam Screw
SP-B502-944	A/R MS Series Cam
SP-B502-945	A/R 4070 Series Cam
SP-B502-948	Standard Mortise Cam
SP-L583-153	L Series Cam
SP-B520-329	Arrow 004, Yale 2160
SP-B520-309	Corbin Russwin ML2200 (not 2255/2242)
SP-B520-366	Corbin Russwin DL4000 Series
SP-B520-367	Corbin Russwin A65 (pre1993)
SP-B520-329	Sargent 13-0660 (not 16/in or 50/out)



SP-B502-944



SP-B502-945



SP-B502-948



SP-L583-153



SP-B520-329



SP-B520-309



SP-B520-366



SP-B520-367

©ZIPF LOCK COMPANY

SCHLAGE

MISCELLANEOUS PARTS



SC-C503-347



LB-SC-C503-115



LB-SC-C503-116

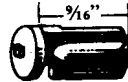

SC-B202-370

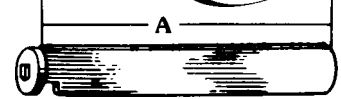

SC-B202-557 1-27/32"
SC-B202-558 2"



SC-B520-375



SC-B502-310



SC-C503-346

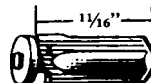

SC-B202-369



SC-B202-453



SC-A508-614 (sold as a set)
for ORB, COM, PLA designs



SC-B502-899



SC-C503-118



SC-B202-269
SC-B220-032 1"
SC-B220-036*



SC-A508-606 (sold as a set)
for other designs

*See chart.

BAR AND/OR DRIVER

Stock No.	Description (Pictured above)
SC-A508-606	A, H Series classic conventional 6-pin (not ORB).
SC-A508-614	A Series ORB classic conventional 6-pin (not A73 or A85).
SC-A700-031	AL Series-except hotel function: Bar and driver-not pictured.
SC-B202-269	BC162; B162: 5-pin 1-5/16" to 1-5/8" door; B252/B462: 6-pin 1-3/8", 2-1/4", 2-1/2" door.
SC-B202-369	B252/B462: 6-pin 1-5/8", 1-3/4", 3" door std bar.
SC-B202-370	B252/B462: 5-pin 1-3/8" door std, 6-pin 1-1/2", 2", 2-3/4" door.
SC-B202-453	B252/B462: 5-pin 2-1/2" door.
SC-B202-557	B160: 5-pin 1-3/8" to 1-3/4" door; 6-pin 1-5/8" to 1-3/4" door.
SC-B202-558	B160: 5 or 6-pin 1-13/16" to 2-1/4" door; B250/B460: 5 or 6-pin 1-3/8" to 2-3/4" door std bar; B560: 1-5/8" to 2-1/8" door; F160N; H110/H153 upper cylinder.
SC-B220-032	B162: 5-pin over 1-5/8" to 1-13/16" door, 6-pin over 1-11/16" to 2" door.
SC-B220-036	B162: 6-pin over 2" to 2-1/4" door; F162N.
SC-B520-375	BC100: Driver, classic conventional.
SC-B610-044	B660, B663 driver bar(s) and retainer. 1-3/8" to 2-1/2" doors-not pictured.
SC-B610-045	B662 driver bar(s) and retainer. 1-3/8" to 2" doors-not pictured.
SC-B610-046	B662 driver bar(s) and retainer. Greater than 2" to 2-1/2" doors-not pictured.
SC-C503-346	Spacer for 20-033, 20-066, 20-067, 20-069.
SC-C603-524	D Series: Bar and driver for ATH, RHO and SPA cylinder (23-013)-not pictured.
SC-C604-243	D Series: Bar and driver for knob cylinder (23-001)-not pictured.
SC-F206-437	Thick door kit for F/FA single cylinder handlesets, 2" to 2-1/2". Specify finish: 605, 609, 613, 619, 626.
SC-N523-023	ND Series: Bar and driver for lever cylinder (23-065)-not pictured.
SC-S605-192	S Series: Cylinder sleeve-not pictured.
SC-S605-228	S Series: Driver-not pictured.
SC-XB11-990	BC160P: for doors over 1-3/4" to 2-1/4". (2 ea. B600-101 and 1 ea. B502-999). Specify finish: 605, 626
SC-XB11-991	BC162P: for doors over 1-3/4" to 2-1/4". (2 ea. B600-056 and 2 ea. B220-036). Specify finish: 605, 626

RIM CYLINDER BAR

Stock No.	Description (Pictured above)
SC-B502-899	Rim Cylinder: Bar #1 for 20-021, Bar #2 for 20-002.

SCHLAGE

MISCELLANEOUS PARTS



SC-01-060
605, 626

Inside plunger unit for A53 (not ORB design)

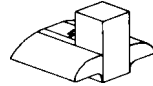

SC-A501-615

To convert entrance to vestibule function (A, AL, H)

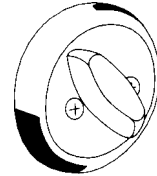

SC-B202-671

605, 609, 626

Rose and turn, no hold back for B250.

SC-B220-030

626

Rose & turn for B160. (not pictured)

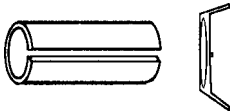

SC-37-001 138 For 1-3/8" thick doors

SC-37-001 134 For 1-3/4" thick doors

A, AL and D Series Reinforcement Kit. For when installing locks in non-reinforced hollow metal or metal clad doors.



SC-A501-878

Faceplate adaptor to adapt 1" faceplate to 1-1/8" door preparation.

SC-A501-311

Slide spring for AL Series locks.

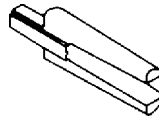

SC-A700-015

AL lever insert before May 2002

SC-A700-044 (Special order)

AL lever insert after May 2002

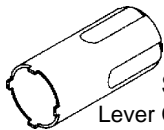

SC-40-017

Lever Castle Nut Wrench

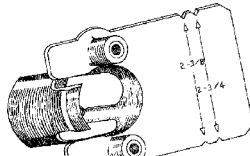

SC-40-080

Thru-bolt Jig

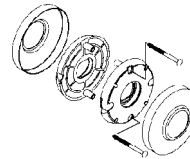

\$\$\$C-38-075

Retrofit Spring Cage Kit (Discontinued by Factory)
Call for closeout prices

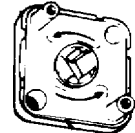

SC-L283-040

L Spring Cage

SCREW PACKS

Stock No.	Description
SC-B220-050	Adams Rite screw pack for Schlage mortise cylinders.
SC-B610-050	Standard screw pack (2 each) for B660, 661, 663, P&R. 1-3/8" to 2" doors
SC-B610-051	Standard screw pack (2 each) for B660, 661, 663, P&R. Over 2" to 2-1/2" doors
SC-B610-053	Standard screw pack (2 each) for B662P. 1-3/8" to 2" doors
SC-B610-055	Standard screw pack (2 each) for B662P. Over 2" to 2-1/2" doors

MISCELLANEOUS PARTS (pictured above)

Stock No.	Description
SC-A700-015	AL Series lever insert, 1-3/8" to 1-7/8" doors. (pictured above). Locks manufactured before May 2002.
SC-B520-322	MD, ME Series. Faceplate for latches. Specify finish: 605 or 626. Discontinued by factory.
\$\$\$C-38-075	Retrofit Spring Cage Kit. Spring cages and roses to convert D-Series lever locks manufactured before 1994. Consist of 1 ea. C303-035, C303-036, C303-438 and 2 ea 04-060. Specify finish: 605, 613, 626. (pictured above) Discontinued by factory. Call for closeout prices.
SC-40-017	AL and D-Series Lever castle nut wrench (metal). (pictured above)
SC-40-080	AL and D-Series lever thru-bolt jig. (pictured above)
SC-L283-040	Spring cage for L Series (1 required per lever). (pictured above)
SC-L283-060	Spindle and spring for L Series for 1-3/8" - 1-7/8" doors (2 required per lock). Not pictured.

SCHLAGE



KEYING KITS AND ACCESSORIES

SC-40-134

Pin Kit, Snap-Tight Plastic Box

Contents:

Bottom pins, top pins, pin springs, retainer cap pins, key gage, follower bar.

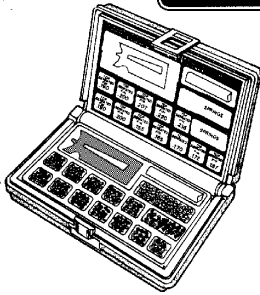

SC-40-119 Pin Kit, Seal-Tight Metal Box

Contents:

Bottom pins, master pins, top pins, pin springs, retainer caps, retainer cap pins, retainer cap pin springs, shim stock, tweezers, follower bar, removal tool.

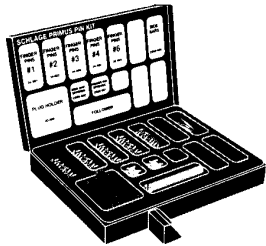

SP-40-070 Primus® Finger Pin Kit,

Contents:

Sidebar, finger pin springs, finger pins (1,2,3,4,6), Plug holder, sidebar springs and follower.

SC-40-095 (Not pictured)

Compressible Cylinder Upgrade Kit (F Series)

Contents:

One pack each of SC-F506-451, 452, 453; Plastic replacement tray, One each replacement pin charts for keying kits SC-40-119, 133, 134; instruction sheet and a CD-ROM on rekeying the new cylinder.

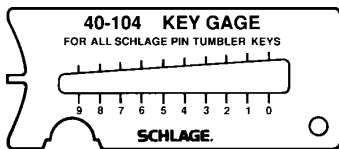

SC-40-104

Key gage for all Schlage keys (except SFIC).

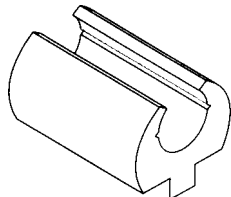

SP-40-066

Primus® plug holder.

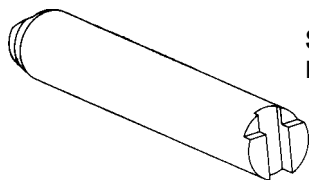

SC-M540-051

Follower

Primus Pins and Springs

	Stock No.
#1 Finger Pin	SP-34-001
#2 Finger Pin	SP-34-002
#3 Finger Pin	SP-34-003
#4 Finger Pin	SP-34-004
#6 Finger Pin	SP-34-006
Finger Pin Spring	SP-C603-951
Everest Check Pin Spring	SP-C603-951
Sidebar Spring	SP-C603-952
Sidebar	SP-C603-950

Top, Master & Bottom pins can be used on Primus & Everest Primus "Controlled Access" and Schlage Standard & Everest Cylinders.

Regular & Primus Pins and Springs

		*LAB Stock No.
#1 Top Pin	34-101	LB-SC-34-101
#2 Top Pin	34-102	LB-SC-34-102
#3 Top Pin	34-103	LB-SC-34-103
#2 Master Pin	34-202	LB-SC-34-202
#3 Master Pin	34-203	LB-SC-34-203
#4 Master Pin	34-204	LB-SC-34-204
#5 Master Pin	34-205	LB-SC-34-205
#6 Master Pin	34-206	LB-SC-34-206
#7 Master Pin	34-207	LB-SC-34-207
#8 Master Pin	34-208	LB-SC-34-208
#9 Master Pin	34-209	LB-SC-34-209
#0 Bottom Pin	34-300	LB-SC-34-300
#1 Bottom Pin	34-301	LB-SC-34-301
#2 Bottom Pin	34-302	LB-SC-34-302
#3 Bottom Pin	34-303	LB-SC-34-303
#4 Bottom Pin	34-304	LB-SC-34-304
#5 Bottom Pin	34-305	LB-SC-34-305
#6 Bottom Pin	34-306	LB-SC-34-306
#7 Bottom Pin	34-307	LB-SC-34-307
#8 Bottom Pin	34-308	LB-SC-34-308
#9 Bottom Pin	34-309	LB-SC-34-309

*LAB "Original Pins for Schlage". Sold in plastic Vials.

F Series Compressible Cylinder

	Stock No.
Top T-Pin	SC-F506-451
Removable Cap	SC-F506-452
T-Pin Top Spring	SC-F506-453

Pins and Springs

	Stock No.
Pin Tumbler Spring	LB-SPR-115L
Cap Retainer Pin Spring	LB-SC-C503-115
SFIC 20S Tumbler Spring	SC-C504-114
Full Size I/C Control Bottom Pin	SC-C603-967
Retainer Cap Pin	LB-SC-C503-116
Retainer Cap	SC-C503-118

SCHLAGE

SCHLAGE

ACCESSORIES

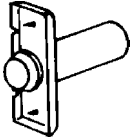

SC-40-030 Strike Marking Chisel
(For strikes - 1-1/8" x 2-3/4")

SC-40-031 Latch Marking Chisel
(For latches - 1" x 2-1/4")

SC-40-032 Latch Marking Chisel
(For latches - 1-1/8" x 2-1/4")

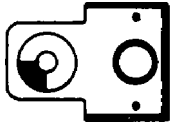

SC-40-029 Strike Marking Chisel
(Full Lip Strikes)

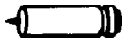

***SC-40-035** Strike Locator - 7/8"
(7/8" diameter)



***SC-40-016** Boring Bit - 7/8"
(7/8" diameter)

***Limited Supply.** These items have discontinued by factory. Call for close-out prices.

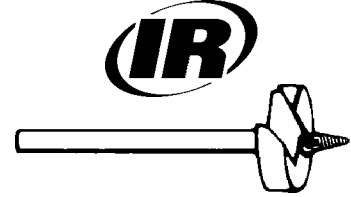

***SC-40-024** Boring Bit 2-1/8"
(For 40-056 jig)

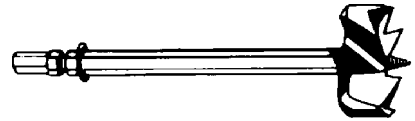

***SC-40-028** Boring Bit 1-1/2"



SC-40-080
AL & D-Series Lever Thru-bolt Jig
For use when installing AL or D Series Levers. This jig will make drilling the thru-bolt easy and accurate.



SC-M504-413
Installation Tool -
For interchangeable core.

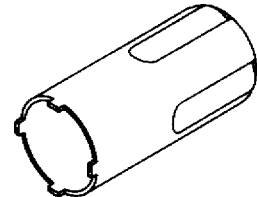

SC-40-017 AL & D-Series
Lever castle nut wrench.

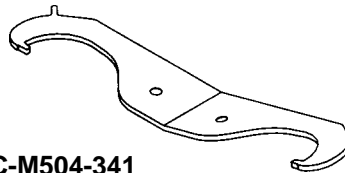

SC-M504-341
Spanner wrench for D Series knobs
and L Series.

PADLOCKS

PADLOCKS — STANDARD AND INTERCHANGEABLE CORE

SCHLAGE

Rolling change on padlocks. The name will be changing from Schlage to Kryptonite per Schlage.

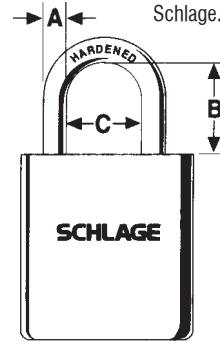

1-3/4" Wide Body, Standard 6-Pin C or E Keyway

Stock No.	"A"	"B"	"C"
PL1001KD	5/16"	1-1/8"	3/4"
PL1002KD	5/16"	2"	3/4"
PL1003KD	5/16"	3"	3/4"

Keyway: C or E.

2" Wide Body, Schlage Full Size Interchangeable Core

Stock No.	"A"	"B"	"C"
PL4002	3/8"	2"	3/4"

Keyway: C or E.

2" Wide Body, Primus Full Size Interchangeable Core

Stock No.	"A"	"B"	"C"	Restricted-
PL4742	3/8"	2"	3/4"	Call for Details

Keyway: CP+(1313), EP+(1318), C123 or C145.

TO ORDER: Specify Stock No. and Keyway.

452-Satin Brass Finish

PL1000 Series furnished 6-pin keyed 5-pin. Key Different.

PL4002 furnished 1-bitted with two 6-pin keys. Control keys must be ordered separately.

PL4742 furnished 0-bitted less keys. Control keys must be ordered separately.

PUSH/PULL/KICK PLATES

Solid Brass, stainless steel and aluminum plates, protect doors from marring or damage. All mounting screws included.



PULL PLATES PUSH PLATES

MAG-9041V(VisualPack)

Finishes: 605, 613, 630

PLATE: 3-1/2" x 15"

CAST PULL: 6-5/8" x

1-3/4" projection

C to C: 5-1/2"

ANSI: J405

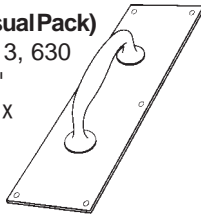

MAG-9051

Finishes: 613, 628, 630

PLATE: 3-1/2" x 15"

PULL: 3/4" Dia. round,
8-3/4" x 2-1/4" projection

C to C: 8"

ANSI: J405

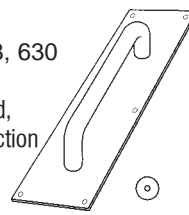

MAG-9031

Finishes: 605, 609, 613,

619, 620, 628, 630

PLATE: 3-1/2" x 15"

ANSI: J301

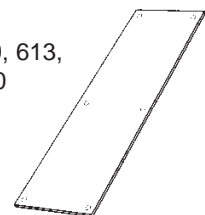

MAG-9045

Finishes: 605, 613, 628

PLATE: 3-1/2" x 15"

PULL: 5/8" Dia. round,
6-1/8" x 2" projection

C to C: 5-1/2"

ANSI: J405

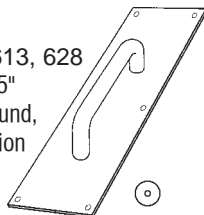

MAG-9053

Finishes: 630

PLATE: 3-1/2" x 15"

PULL: 1-1/4" flat,
6-3/8" x 2" projection

C to C: 6"

ANSI: J405

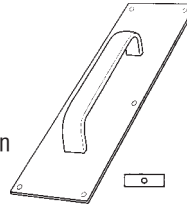

MAG-9031V(VisualPack)

Finishes: 605, 613, 630

PLATE: 3-1/2" x 15"

ANSI: J301

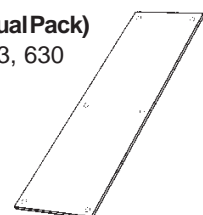

MAG-9049

Finishes: 605, 613, 619, 628

PLATE: 3-1/2" x 15"

PULL: 3/4" Dia. round,
6-3/4" x 2-1/4" projection

C to C: 6"

ANSI: J405

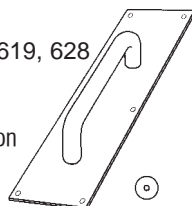

Specify Finish when ordering.

Mag Finishes:

- 605 Bright Brass
- 609 Antique Brass
- 613 Oil Rubbed Bronze
- 619 Satin Nickel
- 620 Antique Nickel
- 628 Aluminum
- 630 Satin Stainless Steel