

DOOR KNOCKERS & BUTTONS

DOOR KNOCKERS—

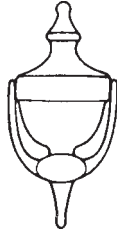

Stock No.
IV-3102-605
Finishes: 605

Door Knocker

- Knocker made from forged brass.
- Knocker Dimensions:
Length: 6-7/16"
Width: 2-15/16"
Projection: 15/16"
Mounting Hole Center-to-Center: 4-1/8"



Stock No. (*Specify Finish)
IV-3107- * -MAG

*Finishes: 505, 605

Door Knocker with Magnetic Mounting

- Knocker made from forged brass.
- Features magnetic mounting on metal doors.
- Knocker Dimensions:
Length: 8-1/2"
Width: 4-1/8"
Projection: 1"



Stock No.
IV-3122-605
Finishes: 605

Door Knocker

- Knocker made from wrought brass.
- Dimensions:
Length: 4"
Width: 2-3/16"
Projection: 9/16"
Mounting Hole Center-to-Center: 3-7/32"



IV-3125



IV-31252

Stock No. (Specify Finish)

IV-3125 No Viewer

Finishes: 505, 605, 609, 613, 619, 620, 626

IV-31252 With 701 Viewer (120°)

Finishes: 505, 605, 609, 613, 619, 620, 625, 626

Door Knocker with Optional Viewers

- Knocker made from forged brass.
- Viewers supplied in B4 or B26D. 120° angle of view. 1/2" hole.
- Dimensions:
Length: 5-15/16"
Width: 3"
Projection: 1-1/16"
Mounting Hole Center-to-Center: 3-15/16"

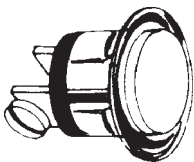

PUSH BUTTONS

Stock No.	Finish
TR-45A	Silver Rim
TR-45G	Gold Rim

UNLIGHTED—5/8" diameter.



PUSH BUTTONS

Stock No.	Finish
TR-71A	Silver Rim
TR-71G	Gold Rim

UNLIGHTED—2-3/4" L x 1"W x 3/4"H.

©ZIPF LOCK COMPANY

DOOR STOPS & BUMPERS

DOOR STOPS (Residential)—



Flexible Door Stops

Features:

- Utilizes heavy gauge spring to maintain rigid protections.
- Simple to install - only a screwdriver required.
- Rubber tip is replaceable (special order).
- Made from burnished wrought steel.
- Meets design requirements of ANSI/BHMA A156.16.
- Packed disassembled for quick installation.
- Projection: IV-060 3"; IV-061 4".



Stock No. (Specify Finish)

IV-060F 3" Projection

IV-061F 4" Projection

Finishes: 3, 5, 10B, 14

Base Door Stops

- Rubber tip is replaceable (special order).
- Projection: 3-1/8" on brass units. 3-3/16" on aluminum units.
- Made from solid brass, or aluminum.



Stock No. (Specify Finish)

IV-61A 3-3/16" Projection - Alum

Finishes: 3, 5, 10B, 14, 92

IV-61MB 3-1/8" Projection - Brass

Finishes: 3, 5, 10B, 15, 15A, 26, 26D

Hinge Pin Door Stop

- For use on hinged doors where the installation of a standard door stop is not desirable.
- Positive slip proof adjustment.
- Non-marring rubber tips.
- Removable bushings accommodate 1/4" to 5/16" diameter hinge pins.
- Easy installation - only a screwdriver required.
- Made from burnished wrought steel.
- Door Openings Adjustments: From 70° to 100°.



Stock No. (Specify Finish)

IV-69F 70° to 100° opening

Finishes: 3, 10B, 14, 15, 15A

Hinge Pin Door Stop

- For use on hinged doors where the installation of a standard door stop is not desirable.
- Designed for narrow trim installation.
- High quality rubber bumpers - shoulder on stud supports rubber through entire body for engineered cushioning.
- Replaceable, non-marring rubber tips (special order).
- Removable bushings accommodate 1/4" to 5/16" diameter hinge pins.
- Easy installation.
- Made from solid brass, aluminum or epoxy coated aluminum.
- Door Openings Adjustments: 85° to 125° opening

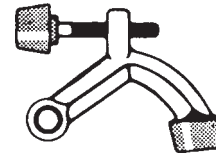

Stock No. (Specify Finish)

IV-70A Aluminum

Finishes: 3, 5, 10B, 14, 92, W

IV-70B Brass

Finishes: 3, 10B, 15, 15A, 26

FLOOR DOOR STOPS & HOLDERS—

Dome Stop

- For doors without threshold.
- Heavy-Duty Cast Dome Stops constructed of brass, bronze or aluminum.
- Gray, non-marring rubber bumper.
- Packed with wood screw and plastic anchor. Specify Tampin (TPN) or lead expansion shield (LS), if required. - **Special order only.**
- Meets ANSI/BHMA 156.6, L12141 for brass or bronze and L32141 for aluminum.

• Overall Height
1"

• Base Height
3/16"

• Base Diameter
1-3/4" x 2" Oval

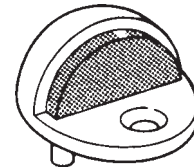

Stock No. (Specify Finish)

IV-FS436

Finishes: 3, 5, 10B, 15, 15A, 26, 26D, 28

©ZIPF LOCK COMPANY

See page 320 for finish descriptions.

317
(PL-26)

DOOR STOPS & BUMPERS

FLOOR DOOR STOPS & HOLDERS— (cont'd)



Dome Stop

- For doors with threshold or undercut doors.
- Heavy-Duty Cast Dome Stops constructed of brass, bronze or aluminum.
- Gray, non-marring rubber bumper.
- Packed with wood screw and plastic anchor, specify Tampin (TPN) or lead expansion shield (LS), if required. - **Special order only.**
- Meets ANSI/BHMA 156.6, L12141 for brass or bronze and L32141 for aluminum.

<u>Overall Height</u>	<u>Base Height</u>	<u>Base Diameter</u>
1-3/8"	9/16"	1-3/4" x 2" Oval

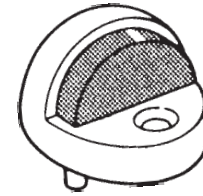

Stock No. (Specify Finish)

IV-FS438

Finishes: 3, 5, 10B, 15, 15A, 26, 26D, 28

Floor Stops

- Designed to blend well with all types of construction and provide a minimum of hindrance to cleaning efforts.
- Accommodates door undercut up to 1-1/2".
- Heavy-Duty cast brass or aluminum construction.
- Non-marring rubber bumper.
- Packed with expansion shield and tampin.
- Meets ANSI/BHMA 156.16, L12131 for brass and L32131 for aluminum.

<u>Overall Height</u>	<u>Base Height</u>	<u>Base Depth</u>
2-1/8"	2-7/8"	1-5/8"



Stock No. (Specify Finish)

IV-FS441

Finishes: 3, 10B, 15, 15A, 26, 26D

Floor Stops

- Burnished wrought steel.
- Soft, resilient gray rubber.
- For undercut doors up to 1-1/2".
- Packed with screws and plastic anchors.

<u>Overall Height</u>	<u>Base Size</u>
2-5/8"	1-1/2" W x 2-3/4" L

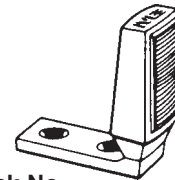

Stock No.

IV-FS434 2C

Finishes: 2C

Kick Down Holders

- Units provide simple hold and release, activated with a touch of the foot.
- Cast brass or aluminum construction.
- Non-marring rubber shoes have corrugated bottoms to provide secure grip and a shank which forms its own thread when screwed into threaded cavity of holder. When worn, shoes are easily replaced (special order).
- Door-to-floor clearances of 2" or less.
- Meets ANSI/BHMA 156.16, L11382 for brass and L31382 for aluminum.

<u>Door-to-Floor Clearance</u>	<u>Plate Height</u>	<u>Plate Width</u>
2" or less	1-3/4"	1-3/4"



Stock No. (Specify Finish)

IV-FS455

Finishes: 3, 3AL, 10B, 26D, 27/A92

Automatic Door Holders

- Automatic door holders ideal for heavy-traffic situations that require a simple, Hold-Open device.
- Cast brass construction.
- Holds door 3-3/4" from wall.
- Recommended installation is holder on door and strike on wall.
- Holder position on door is adjustable.
- Holder is tapered to prevent "child riding".
- Meets ANSI/BHMA 156.16, L11291 for brass.

US3, 4, 10, 10B, 26 Available by special order

Stock No.

IV-FS495 26D

Finishes: 26D

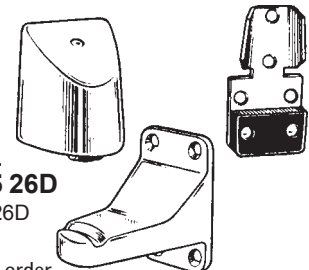

DOOR STOPS & BUMPERS

FLOOR DOOR STOPS & HOLDERS— (cont'd)

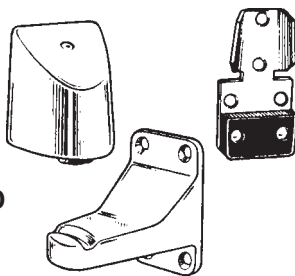

Stock No.
IV-FS496 26D
Finishes: 26D

US3, 4, 10, 10B, 26
Available by special order

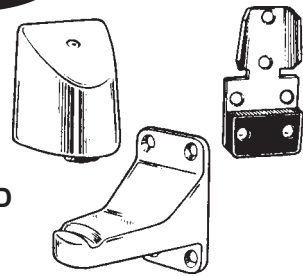

Stock No.
IV-FS497 26D
Finishes: 26D

Automatic Door Holders

- Cast brass construction.
- For door to floor clearances of 3/8" maximum.
- Meets ANSI/BHMA 156.16, L11301 for brass.

Automatic Door Holders

- Cast brass construction.
- For door to floor clearances of 1" maximum.
- Meets ANSI/BHMA 156.16, L11301 for brass.

WALL BUMPERS—

Concave Rubber Bumper

- Constructed in heavy-duty cast brass or aluminum base.
- Special retainer cup makes rubber tamper resistant.
- The IV-WS402CCV unit is designed with a concave rubber bumper which avoids damage to locks with projecting buttons and is packed with screw and drywall anchor.
- IV-WS402CCV meets ANSI/BHMA 156.16 L12251 for brass and L32251 for aluminum.
- Dimensions: Base Diameter: 2-1/2", Base Thickness: 3/8", Projection: 1"

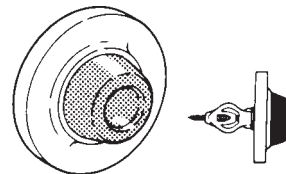

Stock No. (Specify Finish)
IV-WS402-CCV
Finishes: 3, 5, 10B, 26, 26D, 28

Convex Rubber Bumper

- Constructed in heavy-duty cast brass or aluminum base.
- Special retainer cup makes rubber tamper resistant.
- The IV-WS402CVX unit is designed with a convex rubber bumper packed with screw and drywall anchor.
- IV-WS402CVX meets ANSI/BHMA 156.16 L12101 for brass and L32101 for aluminum.
- Dimensions: Base Diameter: 2-1/2", Base Thickness: 3/8", Projection: 1"

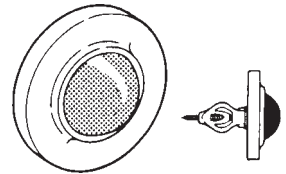

Stock No. (Specify Finish)
IV-WS402-CVX
Finishes: 3, 10B, 15, 15A, 26, 26D, 28

Compact Size Convex Rubber Bumper

- Constructed in cast brass.
- Compact size.
- Totally concealed mounting discourages vandalism or tampering.
- Unit furnished with grey convex rubber bumper.
- Packed with sheet metal screw, rawl plug and brad.
- Dimensions: Diameter: 1", Projection: 17/32"

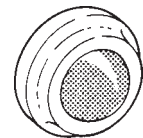

Stock No. (Specify Finish)
IV-WS404-CVX
Finishes: 3, 5, 10B, 15, 15A, 26, 26D

Economical Concave Rubber Bumper

- Constructed in sturdy yet economical wrought base of brass, aluminum or stainless steel construction.
- Feature concealed tamper-proof mounting.
- Shipped factory preassembled backplate to reduce installation cost.
- Easy installation by inserting screwdriver through small hole in rubber.
- The IV-WS407CCV unit is designed with a concave rubber bumper which avoids damage to locks with projecting buttons and is packed with screw and drywall anchor.
- IV-WS407CCV meets ANSI/BHMA 156.16 L22251 for brass and L42251 for aluminum, and L52251 for stainless steel.
- Dimensions: Base Diameter: 2-1/2", Base Thickness: 3/8", Projection: 1"

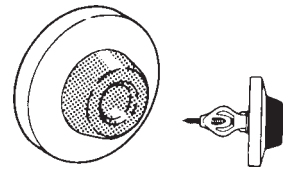

Stock No. (Specify Finish)
IV-WS407-CCV
Finishes: 3, 5, 10B, 15, 15A, 26, 26D, 28, 32D

©ZIPF LOCK COMPANY

See page 320 for finish descriptions.

DOOR STOPS & BUMPERS

WALL BUMPERS— (cont'd)



Economical Convex Rubber Bumper

- Constructed in sturdy yet economical wrought base of brass, aluminum or stainless steel construction.
- Feature concealed tamper-proof mounting.
- Shipped factory preassembled backplate to reduce installation cost.
- Easy installation by inserting screwdriver through small hole in rubber.
- The IV-WS407CVX unit is designed with a convex rubber bumper packed with screw and drywall anchor.
- IV-WS407CVX meets ANSI/BHMA 156.16 L22201 for brass, L42101 for aluminum and L52101 for stainless steel.
- Dimensions: Base Diameter: 2-1/2", Base Thickness: 3/8", Projection: 1"

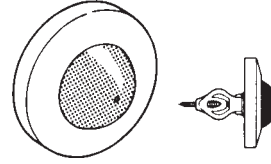

Stock No. (Specify Finish)
IV-WS407-CVX

Finishes: 3, 5, 10B, 15, 15A, 26, 26D, 28, 32D

Adhesive-Backed Rubber Bumper

- Adhesive-backed wall door stop for use on clean, smooth, flat surfaces only.
- Non-marring rubber available in gray or white.
- Concave design permits knob to strike stop without damaging or engaging lock mechanism.
- Dimensions: Base Diameter: 1-7/8", Base Thickness: 3/8", Projection: 1-1/16"

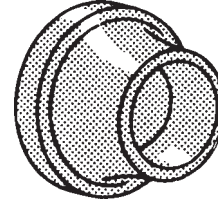

Stock No. (Specify Finish)
IV-411R-W

Finishes: W-White Rubber

WALL STOP—

Wall Stop

- Constructed in brass or aluminum.
- Ideal for interior or exterior use.
- Non-marring rubber tip.
- Furnished with 3 mounting holes for drywall mounting.
- Packed with wood screws.
- Meets ANSI/BHMA 156.16, L12011 for brass and L32011 for aluminum.
- Dimensions: Base Diameter: 2-1/4", Projection: 3-11/16"



Stock No. (Specify Finish)
IV-WS447

Finishes: 3, 10B, 15, 15A, 26, 26D, 28

—FINISHES—

Ives:

US-3	Bright Brass, clear coated
US-4	Satin Brass, clear coated
US-5	Antique Brass, clear coated
US-10B	Oil Rubbed Bronze
US-15	Satin Nickel, clear coated
US-15A	Antique Nickel, clear coated
US-26	Bright Chrome
US-26D	Satin Chrome
US-27	Satin Aluminum, clear anodized alum.
US-28	Satin Aluminum, clear anodized.
US-32D	Satin Stainless Steel
2C	Zinc Plated
3AL	Plated Bright Brass, clear coated
14	Bright Nickel Plated, clear coated
92	Aluminum clear coated
W	White Epoxy Coated

Cal Royal:

US-3	Bright Brass
US-4	Satin Brass
US-5	Antique Brass
US-10	Satin Bronze
US-10B	Oil Rubbed Bronze
US-15	Satin Nickel
US-15A	Satin Nickel Oxidized
US-26	Bright Chrome
US-26D	Satin Chrome
US-32D	Satin Stainless Steel
DURO	Duronodic

Don Jo:

605	Bright Brass
609	Antique Brass
613	Oil Rubbed Bronze
619	Satin Nickel
620	Antique Nickel
625	Bright Chrome
626	Satin Chrome
630	Satin Stainless Steel
AL	Sprayed Aluminum
BP	Brass Plated

MISCELLANEOUS PARTS

MISCELLANEOUS PARTS



SC-C503-347



LB-SC-C503-115



LB-SC-C503-116

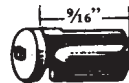

SC-B202-370



SC-B520-375



SC-B502-310



SC-C503-346



SC-B202-369



SC-B202-453



SC-B502-899



SC-C503-118



SC-B202-269
SC-B220-032 1"
SC-B220-036*

*See chart.



SC-B202-557 1-27/32"
SC-B202-558 2"



SC-A508-614 (sold as a set)
for ORB, COM, PLA designs



SC-A508-606 (sold as a set)
for other designs

BAR AND/OR DRIVER

Stock No.	Description (Pictured above)
SC-A508-606	A, H Series classic conventional 6-pin (not ORB).
SC-A508-614	A Series ORB classic conventional 6-pin (not A73 or A85).
SC-A700-031	AL Series-except hotel function: Bar and driver-not pictured.
SC-B202-269	BC162; B162: 5-pin 1-5/16" to 1-5/8" door; B252/B462: 6-pin 1-3/8", 2-1/4", 2-1/2" door.
SC-B202-369	B252/B462: 6-pin 1-5/8", 1-3/4", 3" door std bar.
SC-B202-370	B252/B462: 5-pin 1-3/8" door std, 6-pin 1-1/2", 2", 2-3/4" door.
SC-B202-453	B252/B462: 5-pin 2-1/2" door.
SC-B202-557	B160: 5-pin 1-3/8" to 1-3/4" door; 6-pin 1-5/8" to 1-3/4" door.
SC-B202-558	B160: 5 or 6-pin 1-13/16" to 2-1/4" door; B250/B460: 5 or 6-pin 1-3/8" to 2-3/4" door std bar; B560: 1-5/8" to 2-1/8" door; F160N; H110/H153 upper cylinder.
SC-B220-032	B162: 5-pin over 1-5/8" to 1-13/16" door, 6-pin over 1-11/16" to 2" door.
SC-B220-036	B162: 6-pin over 2" to 2-1/4" door; F162N.
SC-B520-375	BC100: Driver, classic conventional.
SC-B610-044	B660, B663 driver bar(s) and retainer. 1-3/8" to 2-1/2" doors-not pictured.
SC-B610-045	B662 driver bar(s) and retainer. 1-3/8" to 2" doors-not pictured.
SC-B610-046	B662 driver bar(s) and retainer. Greater than 2" to 2-1/2" doors-not pictured.
SC-C503-346	Spacer for 20-033, 20-066, 20-067, 20-069.
SC-C603-524	D Series: Bar and driver for ATH, RHO and SPA cylinder (23-013)-not pictured.
SC-C604-243	D Series: Bar and driver for knob cylinder (23-001)-not pictured.
SC-F206-437	Thick door kit for F/FA single cylinder handlesets, 2" to 2-1/2". Specify finish: 605, 609, 613, 619, 626.
SC-N523-023	ND Series: Bar and driver for lever cylinder (23-065)-not pictured.
SC-S605-192	S Series: Cylinder sleeve-not pictured.
SC-S605-228	S Series: Driver-not pictured.
SC-XB11-990	BC160P: for doors over 1-3/4" to 2-1/4". (2 ea. B600-101 and 1 ea. B502-999). Specify finish: 605, 626
SC-XB11-991	BC162P: for doors over 1-3/4" to 2-1/4". (2 ea. B600-056 and 2 ea. B220-036). Specify finish: 605, 626

RIM CYLINDER BAR

Stock No.	Description (Pictured above)
SC-B502-899	Rim Cylinder: Bar #1 for 20-021, Bar #2 for 20-002.

©ZIPF LOCK COMPANY

MISCELLANEOUS

BALL LATCHES

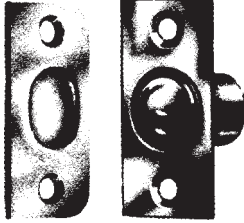

CR-BC97

US3, 5, 10B, 15A
Adjustable Ball Catch
(2-1/4" x 1") w/full lip round
corner strike plate (w/screws)

CAL-ROYAL

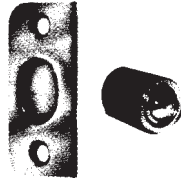

CR-DIB1

US3, 5, 10B, 15, 15A, 26, 26D
Adjustable Drive in Ball Catch w/full
lip round corner strike plate.
(w/screws)

\$-Discontinued. Call for
closeout prices.

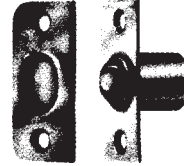

\$CR-NBC110

US3, 5
Ball Catch
(5/8"D x 3/4"W x 2-1/4"L).
For doors 1-3/8" thick
Non adjustable. (w/screws)

DON-JO

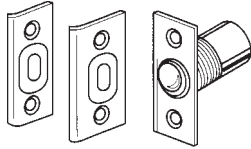

DJ-1712

Finishes: 605, 613, 620, 626
Dimensions: 2-1/8" x 1"; **Material:** Cast
Brass. Packed with narrow and wide
strike. Adjustable

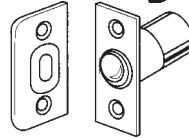

DJ-1714

Finishes: 605, 609
Dimensions: 2-1/4" x 1"; **Material:** Cast
Aluminum. Packed with full lip round
corner strike.

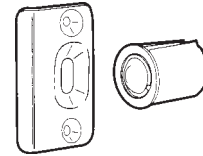

DJ-1716

Finishes: 605, 609, 613, 619, 620, 626
Dimensions: 1"; **Material:** Cast Brass.
Drive-in ball catch.

IVES

Roller Catch

- Smooth, positive latching action insured by powerful conical spring.
- Durable nylon roller insures quiet operation.
- Adjustable tension. Adjustments can be varied from 4 to 17 lbs. of holding power making possible a wide range of door performance.
- Easily installed on thin doors.
- Full lip style strike designed for simplified mortising.
- Made from wrought brass or wrought steel.
- Packed with sheet metal screws.
- Conforms to ANSI/BHMA A156.16 L27081 for brass and L87081 for steel.
- Dimensions:
Face Plate: 2-1/4" x 7/8"
Bore: 13/16" x 1-3/4"
Strike: 2-1/4" x 1-5/8" Lip 1-13/16" to center

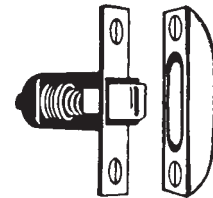

Stock No. (Specify Finish)

IV-335B Brass

Finishes: 3, 5, 10B, 15, 15A, 26, 26D

IV-335F Steel

Finishes: 3

Adjustable Ball Catch

- Ideal for cabinets and small interior doors.
- Free rolling ball insures smooth, positive and trouble-free action.
- Adjustable threaded barrel compensates for various door clearances.
- Adjustable spring tension.
- Made from wrought brass.
- Conforms to ANSI/BHMA A156.9 B23013.
- Dimensions:
Face Plate: 1-1/2" x 3/4"
Bore: 9/16" x 1"
Strike: 1-1/2" x 25/32". Lip 13/32" to center

IVES

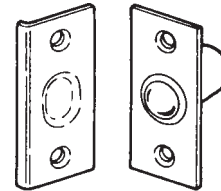

Stock No. (Specify Finish)

IV-345B

Finishes: 3, 5, 10B, 15, 15A, 26, 26D

MISCELLANEOUS

BALL LATCHES

IVES

Dual Adjustable Ball Catch

- For catch in jamb installations.
- Dual adjustment for door clearance and holding strength.
- Narrow strike is designed for use where strike is mounted in door.
- Free rolling ball insures smooth, positive and trouble-free action.
- Adjustable threaded barrel compensates for various door clearances.
- Adjustable spring tension.
- Made from wrought brass.
- Conforms to ANSI/BHMA A156.9 B23013.
- Dimensions:
Face Plate: 2-1/8" x 1"
Bore: 7/8" x 1-3/8"
Strike: 2-1/8" x 1-1/16". Lip 9/16" to center

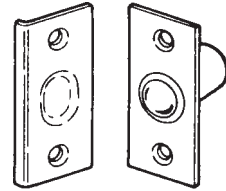

Stock No. (Specify Finish)

IV-346B

Finishes: 3, 10B, 15, 15A, 26, 26D

Dual Adjustable Ball Catch

- For catch in door installations.
- Dual adjustment for door clearance and holding strength.
- Lip strike is designed for use where strike is mounted in jamb.
- Free rolling ball insures smooth, positive and trouble-free action.
- Adjustable threaded barrel compensates for various door clearances.
- Adjustable spring tension.
- Made from wrought brass.
- Conforms to ANSI/BHMA A156.9 B23013.
- Dimensions:
Face Plate: 2-1/8" x 1"
Bore: 7/8" x 1-3/8"
Strike: 2-1/8" x 1-3/8". Lip 7/8" to center

IVES

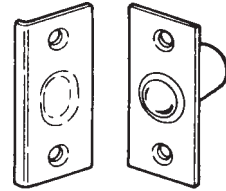

Stock No. (Specify Finish)

IV-347B

Finishes: 3, 5, 10B, 15, 15A, 26, 26D

Ball Catch

- For catch in jamb installations.
- Radiused corners allow easy installations with a router.
- Dual adjustment for door clearance and holding strength.
- Narrow strike is designed for use where strike is mounted in door.
- Free rolling ball insures smooth, positive and trouble-free action.
- Adjustable threaded barrel compensates for various door clearances.
- Adjustable spring tension.
- Made from wrought brass.
- Conforms to ANSI/BHMA A156.9 B23013.
- Dimensions:
Face Plate: 2-1/8" x 1"
Bore: 7/8" x 1-3/8"
Strike: 2-1/8" x 1-1/16". Lip 9/16" to center

IVES

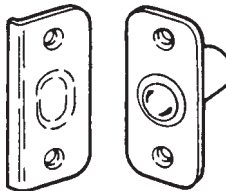

Stock No. (Specify Finish)

IV-348B

Finishes: 3, 10B, 15, 15A, 26, 26D

Ball Catch

- For catch in door installations.
- Radiused corners allow easy installation with a router.
- Dual adjustment for door clearance and holding strength.
- Lip strike is designed for use where strike is mounted in jamb.
- Free rolling ball insures smooth, positive and trouble-free action.
- Adjustable threaded barrel compensates for various door clearances.
- Adjustable spring tension.
- Made from wrought brass.
- Conforms to ANSI/BHMA A156.9 B23013.
- Dimensions:
Face Plate: 2-1/8" x 1"
Bore: 7/8" x 1-3/8"
Strike: 2-1/8" x 1-3/8". Lip 7/8" to center

IVES

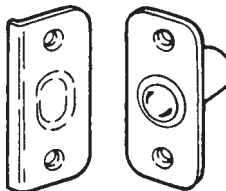

Stock No. (Specify Finish)

IV-349B

Finishes: 3, 5, 10B, 15, 15A, 26, 26D

See page 427 for Cal Royal, Don Jo, Ives finish descriptions.

MISCELLANEOUS

CABINET/CLOSET HARDWARE

CAL-ROYAL

CR-DIFP218

US3, 5, 15, 15A, 26, 26D
 Drive in
 Finger Pull
 2-1/8" Dia.
 No nails



DON-JO

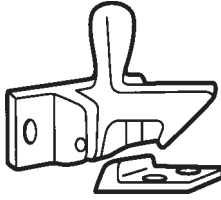

DJ-1590

Finishes: 605, 625
Material: Cast.

IVES

4 per bag.
 Sold by the bag

Finger Pull

- Ideal for use on sliding doors.
- Easy installation.
- Made from wrought brass.
- Conforms to design requirements of ANSI/BHMA A156.9 B22201 and A156.14 D2781.
- Dimensions: Inside Cup Diameter: 3/4"; Overall Diameter: 1"; Depth: 5/16"



Stock No. (Specify Finish)

IV-218BB

Finishes: 3, 15, 15A, 26

Flush Pull

- Low profile makes this pull ideal for louvered, bi-folding or wardrobe doors.
- Extra deep recess and reverse tapered grip provide for ease of pulling and gripping.
- Made from wrought brass.
- Conforms to design requirements of ANSI/BHMA A156.9 B22201 and A156.14 D2781.
- Dimensions: 1-5/16" H x 3-1/8" W x 7/16" D.

IVES



Stock No. (Specify Finish)

IV-22B

Finishes: 3, 10B, 15, 15A, 26, 26D

Flush Pull

- Ideal for use on sliding doors.
- Built-in prong design eliminates the need for screws or brads and facilitates installation.
- Packed with two escutcheon pins for added holding power.
- Made from wrought brass.
- Conforms to design requirements of ANSI/BHMA A156.9 B22201 and A156.14 D2781.
- Dimensions: Inside Cup Diameter: 2-1/8"; Overall Diameter: 2-7/16"; Depth: 7/16"

IVES



Stock No. (Specify Finish)

IV-221B

Finishes: 3, 5, 10B, 15, 15A, 26, 26D

Flush Pull

- Low profile makes this pull ideal for louvered, bi-folding or wardrobe doors.
- Reverse tapered grip provide for ease of pulling.
- Made from cast brass.
- Conforms to design requirements of ANSI/BHMA A156.9 B12201 and A156.14 D1781.
- Dimensions: 3-1/8" H x 1-5/8" W x 7/16" D.

IVES



Stock No. (Specify Finish)

IV-222B

Finishes: 3, 5, 10B, 15, 15A, 26, 26D

MISCELLANEOUS

CABINET/CLOSET HARDWARE

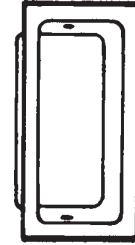

Stock No. (Specify Finish)
IV-223B

Finishes: 3, 5, 10B, 15, 15A, 26, 26D

Flush Pull

- Low profile makes this pull ideal for louvered, bi-folding or wardrobe doors.
- Made from wrought brass.
- Conforms to design requirements of ANSI/BHMA A156.9 B22201 and A156.14 D2781.
- Dimensions: 3-9/16" H x 1-5/16" W x 1/2" D

Stock No. (Specify Finish)
IV-227B

Finishes: 3, 5, 10B, 15, 15A, 26, 26D

Flush Pull

- Contoured for ease of pulling.
- Extra deep well.
- Deluxe quality.
- Made from wrought brass.
- Conforms to design requirements of ANSI/BHMA A156.9 B22201 and A156.14 D2781.
- Dimensions: 3-5/8" H x 1-3/4" W x 9/16" D

Elbow Catch

- Ideal for use on the inactive leaf of a pair of cabinet doors.
- Surface applied, making installation simple.
- Made from cast brass or cast aluminum.
- Conforms to design requirements of ANSI/BHMA A156.9.
- Dimensions:
Plate: 1-3/8" x 5/8"
Strike: 13/16" x 5/8"



Stock No. (Specify Finish)

IV-2A Aluminum

Finishes: 3, 10, 14, 92

IV-2MB Brass

Finishes: 3

Round Knob

- Two diameters stocked: 1" and 1-1/4".
- Made from wrought brass.
- Furnished with a No. 8-32 machine screw, 1-1/8" long.
- Conforms to ANSI/BHMA A156.9 B22131.
- | Model & Diameter | Projection |
|------------------|------------|
| 521 1" | 15/16" |
| 521 1 1/4" | 1-1/8" |



Stock No. (Specify Finish)

IV-521B * 1" 1" Diameter

IV-521B * 1-1/4" 1-1/4" Diameter

*Finishes: 3, 5, 10B, 15, 15A, 26, 26D

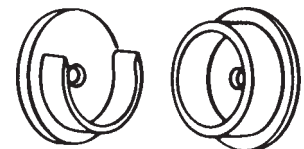
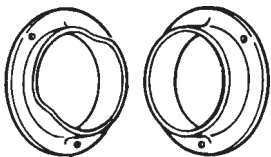

Stock No. (Specify Finish)

IV-585F3

Finishes: 3

Closet Pole Sockets

- Flange design prevents accidental knock out of pole.
- Made from wrought steel.
- Accommodates pole or pipe with outside diameter of 1-3/8".
- Packed in pairs.

Stock No. (Specify Finish)

IV-586P

Finishes: White Plastic

Closet Pole Sockets

- Made from a heavy duty plastic for long life and extra strength.
- Single screw mounting.
- Accommodates pole or pipe with outside diameter of 1-3/8".

©ZIPF LOCK COMPANY

See page 427 for Cal Royal, Don Jo, Ives finish descriptions.

431
(PL-42)

MISCELLANEOUS

DOOR BOLTS

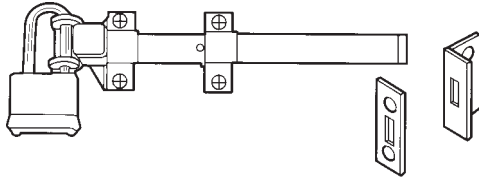

DON-JO

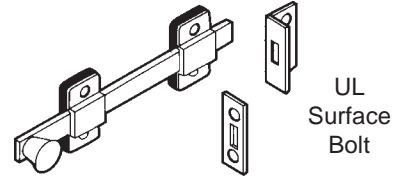

UL
Surface
Bolt

Stock No.	Finish	Size	Throw
DJ-1582	630	8"	1"

- All stainless steel construction.
- Padlock not included.

Stock No.	Finish	Size	ANSI
DJ-1580	626	8"	L84161

- Furnished with Rim and Mortise strikes.

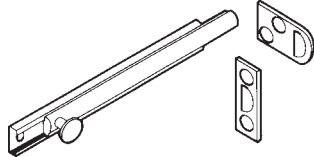

Stock No.	Finish	Size	ANSI
DJ-SB-4	605, 613, 619, 620, 625, 626	4"	L04151
DJ-SB-6	605, 613, 619, 620, 625, 626	6"	L04151

- Furnished with Rim and Mortise strikes.
- 619, 620 finishes are discontinued, Call for closeout prices.

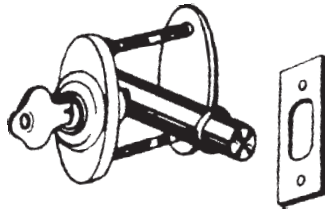

Locking Mortise Bolt
5051-04-51x
Satin Brass

Decorative Surface Bolts

- Concealed screw design enhances appearance and security.
- Exceptional strength and durability provided by interlocking construction of heavy gauge track and rod.
- Permanent stop prevents rod disengagement from track.
- Tension spring holds bolt in desired position.
- Track assures smooth operation and interlocks with side edges of rod to eliminate marring.
- Decorative 5/8" diameter knob designed to facilitate bolt operation.
- Made from extruded brass.
- Available in 4" and 6" lengths.
- Packed with both Universal and Mortise Strikes.
- Meets design requirements of ANSI/BHMA A156.16.
- Dimensions: Throw: 7/16"; Projection: 3/4" Width: 11/16"

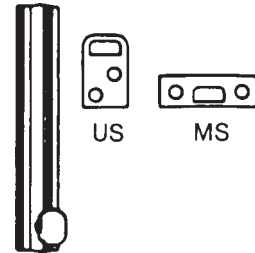

Stock No. (Specify Finish & Length)

IV-40B * 4" 4" length
*Finishes: 3, 5, 10B, 15, 15A, 26, 26D
IV-40B * 6" 6" length
*Finishes: 3, 5, 10B, 15, 15A, 26, 26D

Decorative Surface Bolts

- Features attractive 3/8" half-round rods and well-proportioned guides.
- Semi-concealed guides assure smooth operation and are positioned under the rod to eliminate marring the surface of the bolt.
- Stainless steel tension spring prevents rod disengagement from guide and provides permanent spring tension to hold bolt in desired position.
- Decorative 1/2" diameter knob designed to facilitate bolt operation.
- Made from solid brass or burnished steel.
- Available in 3", 4" and 6" lengths.
- Packed with both Universal and Angle Strikes.
- Meets design requirements of ANSI/BHMA A156.16.
- Dimensions: Throw: 3/4"; Projection: 3/4"; Half Round Rod: 3/8" Overall Width: 1-3/16".

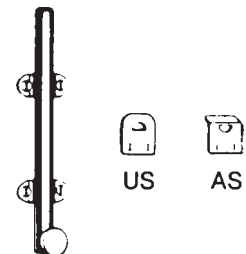

Stock No. (Specify Finish & Length)

IV-043B 4" or 6" length - Brass
Finishes: 3, 10B, 15, 15A, 26, 26D
IV-043F 3", 4", 6" length - Steel
Finishes: 3

©ZIPF LOCK COMPANY

See page 427 for Cal Royal, Don Jo, Ives finish descriptions.

433 v1
(PL-42)

MISCELLANEOUS

DOOR BOLTS

Decorative Surface Bolts

- Features attractive 1/2" half-round rods and well-proportioned guides.
- Semi-concealed guides assure smooth operation and are positioned under the rod to eliminate marring the surface of the bolt.
- Stainless steel tension spring prevents rod disengagement from guide and provides tension to hold bolt in desired position.
- Decorative **3/4" diameter knob** designed to facilitate bolt operation.
- Made from burnished steel.
- Available in 6" length.
- Packed with both Universal and Angle Strikes.
- Meets design requirements of ANSI/BHMA A156.16.
- Dimensions: Throw: 1"; Projection: 15/16"; Half Round Rod: 1/2"; Overall Width: 1-3/8".

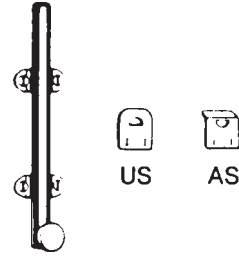

Stock No. (Specify Finish & Length)
IV-43F3 6" 6" length - Steel
Finishes: 3

Dutch Door Bolts

- Practical, rugged, attractive bolt for application on dutch doors as well as other areas.
- Chamfered rod end draws the two leaves of door tightly together.
- Sufficient tolerance provided in strike opening to allow for misalignment of door leaves and also prevents binding of bolt.
- Decorative 1" diameter knob designed to facilitate bolt operation.
- Made from solid brass.
- Packed with Standard Strike.
- Dimensions: Throw: 5/8"; Projection: 1-1/8"; Half Round Rod: 5/8"; Overall Width: 1-5/8"; Rod Length: 4-1/4"; Overall Length, including knob: 4-3/8"

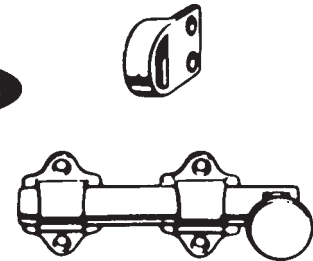

Stock No. (Specify Finish & Length)
IV-054MB 6" length - Steel
Finishes: 3, 26D

Surface Bolt

- Surface Bolt has 1-3/16" throw for maximum security.
- Strong tension springs prevent creep.
- Ideal for all types of doors.
- Available 12" length. (8", 18" and 24" by special order)
- Unit packed with standard screws for added security.
- Unit packed with both a universal top strike (T) and a mortise bottom strike (B).
- Constructed of heavy duty steel.
- 8" and 12" Bolts are UL listed up to 3 hours when used on the inactive door of a pair up to 10' in height.
- Meets ANSI/BHMA A156.16 L84161
- Dimensions: Bar: 3/4" Wide x 1/4" Thick; Overall Width: 2-1/32"; Overall Projection: 1-5/16"
 Top Strike: 1-1/2" x 1-1/2" Angle, 3/16" Thick; Bottom Strike: 3-1/2" Long x 1-5/8" Wide x 1/8" Thick.

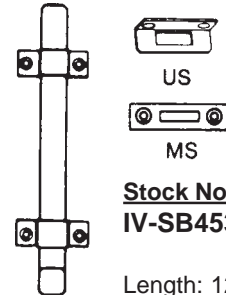

Stock No.
IV-SB453-12-TB 26D

Length: 12"
Finishes: 26D

Master Lock

DUAL FUNCTION DOOR SECURITY BAR

Adjusts to fit most Sliding and Hinged doors

Non-marring yoke (removable for sliding doors)
 Designed to fit most doors, simple push button adjustment.
 High strength steel tube. 20-gauge.
 Portable. Collapsible, to fit most suitcases and garment bags.
 Pivoting ball joint for full contact on floor.
 Padded foot provides sure grip on most floors.
 Lifetime Guarantee.

Stock No.
265D (White)

For Sliding Doors

For Hinged Doors

© ZIPP LOCK COMPANY

DOOR CHAINS

CAL-ROYAL

CR-DG22

US3 Solid Brass
 Chain Door Guard
 6-3/4" Chain

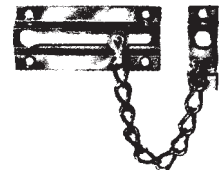

DOOR GUARDS

CAL-ROYAL

CR-BBDHG88

US3, 26D
 Zinc Diecast Swing Bar
 Door Guard with
 ball bearing
Limited supply of US-5.
Call for closeout price.

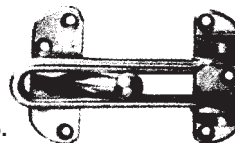

FLIP LOCK MAG-8705

For in-opening doors. Left or right hand.
 Heavy gauge steel.



MISCELLANEOUS

DOOR GUARDS

IVES

- Solid Bar Door Guard is for use on doors that are flush with frames.
- The solid bar, interlocking with the ball on the strike plate, permits the door to be slightly opened to allow viewing.
- The hinged bar allows the door guard to be positioned 180° away from the door when not in use.
- Edge guard, furnished with cast brass door guards, minimizes the chance for marring the door or frame.
- Strike plate is designed to prevent the solid bar from marring the inside of the door when in use.
- Easy installation.
- Meets ANSI/BHMA A156.16.
- Made from cast brass or cast aluminum.
- Packed with sheet metal screws.
- Dimensions of Cast Brass Door Guard: Strike Plate: 2-5/8" x 1-1/32"; Holder: 1-3/4" x 1-1/16"; Arm Length: 4-3/4"; Edge Guard: 1-1/8" x 1-1/32"
- Dimensions of Cast Aluminum Door Guard: Strike Plate: 2-1/2" x 7/8"; Holder: 2-1/2" x 15/16"; Arm Length: 3-13/16".

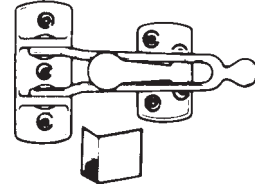

Stock No. (Specify Finish)

IV-482A Cast Aluminum

Finishes: 3, 26D

IV-482B Cast Brass

Finishes: 3, 5, 10B, 15, 26, 26D

DON-JO

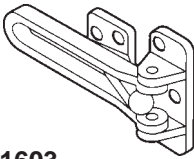

DJ-1603

Finishes: 605, 625, 626
Material: Aluminum. Edge protector included (1" x 1" x 1/2").
ANSI L33042.

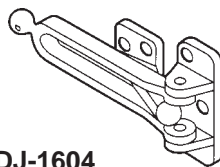

DJ-1604

Finishes: 605, 625, 626
Material: Brass. ANSI L13042.

DOOR SILENCERS

CAL-ROYAL

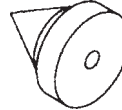

CR-DSM21

Rubber Door Silencer.
1/2" Dia. 11/16"
Length. For metal frames
(Sold in bags of 100)



CR-DSW85

Rubber Door Silencer.
3/8" x 3/4" Base, 3/4" length. For wood frames
(Sold in bags of 100)

DOOR VIEWERS

CAL-ROYAL



160° Door Viewer
1/2" Bore

CR-DV90 (plastic lens)

US3, 10B, 15, 26

CR-ULDV160* (glass lens)

US3, 26

*UL Listed



Door Viewer
9/16" Bore

CR-DV180 180° (plastic lens)

US3, 5, 10B, 15, 26

CR-ULDV200* 200° (glass lens)

US3, 10A, 26

*UL Listed

IVES

One-Way Wide Angle Viewer

- 190° Angle of View.
- Lens projects 1/4" from face of door.
- 4 optical glass lenses.
- For doors 1-3/8" to 2-1/8" thick.
- Solid brass body and barrel.
- Simple installation — only a 9/16" hole required.
- Conforms to ANSI/BHMA A156.16 L23172 and L23222.
- Suggested installation height: 60" from floor.

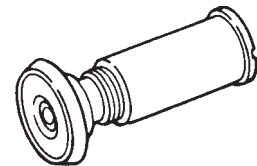

Stock No. (Specify Finish)

IV-698B

Finishes: 3, 26D

One-Way Viewer

- 120° Angle of View.
- For doors 1-3/8" to 2-1/16" thick.
- Secure, tamper-resistant.
- Solid brass body; glass lens.
- Simple installation — only a 1/2" hole required.
- Suggested installation height: 60" from floor.
- Conforms to ANSI/BHMA A156.16 L23173.

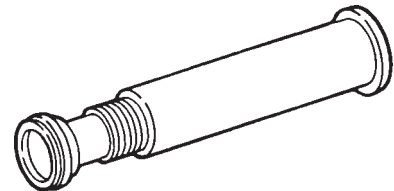

Stock No. (Specify Finish)

IV-700B

Finishes: 4, 26D

©ZIPF LOCK COMPANY

See page 427 for Cal Royal, Don Jo, Ives finish descriptions.

MISCELLANEOUS

DOOR VIEWERS



DOOR VIEWER

Solid Brass with Optical Glass Lens. Fits 1-3/8" to 2" doors. 160° Viewer, 1/2" diameter.

MAG-8720 Brass



DOOR VIEWER-WIDE ANGLE

Solid Brass with Optical Glass Lens. Fits 1-3/8" to 2" doors. 190° Viewer, 1/2" diameter.

MAG-8724 Brass



DOOR VIEWER

Solid Brass with Optical Glass Lens. Fits 1-3/8" to 2" doors. Super Viewer, 1" diameter.

MAG-8728 Brass

FLUSH BOLTS



CR-MB86S

US3, 10B, 15, 15A, 26D
6" Brass Flush Bolt
1" throw

CAL-ROYAL

CR-ULFB634

US3, 10B, 15A, 26, 26D
UL Listed Solid Brass Lever
Extension Flush Bolt
1" x 6-3/4"
12" extension

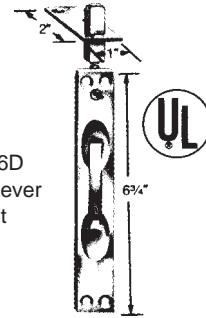

DON-JO

Stock No.	Finishes	Dimensions	ANSI
DJ-1555	626	6-3/4" x 1"	L14251, L14081
DJ-1557	605, 626	6-3/4" x 1"	--
DJ-1640	605, 609, 613, 619, 620, 626	6" x 3/4"	L04201
DJ-1640R	605, 609, 619, 620, 626	6" x 3/4"	L04201



DJ-1555
For Metal
Doors

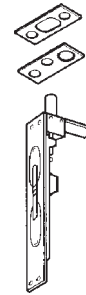

DJ-1557
For Wood
Doors

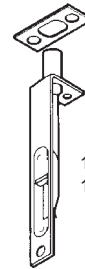

DJ-1640
For Wood
Doors

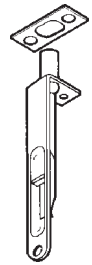

DJ-1640R
For Wood
Doors

Dust Proof Strikes - Threshold Only

- Designed for use with the bottom bolt of the Ives extension flush bolts on non-fire rated openings. For installation in thresholds up to 1/4" thick.
- 3/4" diameter plunger accepts up to 5/8" diameter round bolts or 1/2" square bolts.
- Can be locked in up position by rotating plunger with screwdriver or coin. Eliminates trapping of spiked heels.
- Made from polished wrought brass.
- Dimensions:
Faceplate: 1-3/8" Diameter
Body: 1-61/64" Overall Depth,
Fits Hole 1-1/16" in Dia.

Stock No.
IV-DP3 26D
Finishes: 26D

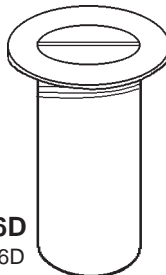

IVES

Manual Flush Bolt - Rounded Face Plate

- Designed with face plate rounded for simple, one-step router installation.
- Steel bolt head in nylon bushing combined with dual action spring lock to hold bolt projected or retracted provides easy, one-finger operation.
- Economically priced for the volume builder.
- Made from polished wrought brass.
- Dimensions:
Body Size: 3/4" Wide x 6-3/4" Long x 5/8" Deep
Strike Size: 5/8" Wide x 1-1/2" Long
Rod Backset: 3/8"
Diameter of Bolt Head: 5/16"
Throw: 3/4"

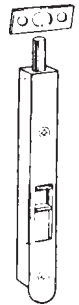

Stock No.
IV-260B3
Finishes: 3

©ZIPF LOCK COMPANY

MISCELLANEOUS

FLUSH BOLTS

Manual Flush Bolt - Square Corner Face Plate

- An exceptionally smooth working flush bolt with sharp, crisp lines.
- Double action spring design provides automatic holding of brass bolt in projected or retracted position, and assures ease of operation in conjunction with deep cup finger hole.
- Made from polished cast brass.
- Dimensions:
 Body Size: 3/4" Wide x 4" Long x 1-1/8" Deep
 Strike Size: 5/8" Wide x 1-1/2" Long
 Rod Backset: 15/32"
 Diameter of Bolt Head: 5/16"
 Throw: 3/4"

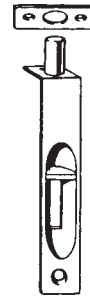

Stock No. (Specify Finish)

IV-261B

Finishes: 3, 5, 10B, 15, 15A, 26, 26D

Manual Flush Bolt - Square Corner Face Plate

- An exceptionally smooth working flush bolt with sharp, crisp lines.
- Double action spring design provides automatic holding of brass bolt in projected or retracted position, and assures ease of operation in conjunction with deep cup finger hole.
- Made from polished cast brass.
- Dimensions:
 Body Size: 3/4" Wide x 6" Long x 1-11/32" Deep
 Strike Size: 7/8" Wide x 1-3/4" Long
 Rod Backset: 15/32"
 Diameter of Bolt Head: 1/2"
 Throw: 1"



Stock No. (Specify Finish)

IV-262B

Finishes: 3, 5, 10B, 15, 15A, 26, 26D

Manual Flush Bolt - Rounded Face Plate

- A compact flush bolt designed specifically for easy, low cost installation.
- Rounded faceplate and lip for simplified installation.
- Double action spring design provides automatic holding of brass bolt in projected or retracted position, and assures ease of operation in conjunction with deep cup finger hole.
- Made from polished cast brass.
- Dimensions:
 Body Size: 3/4" Wide x 5" Long x 1-1/2" Deep
 Strike Size: 5/8" Wide x 1-1/2" Long
 Rod Backset: 15/32"
 Diameter of Bolt Head: 5/16"
 Throw: 3/4"



Stock No. (Specify Finish)

IV-263B

Finishes: 3, 5, 10B, 15, 15A, 26, 26D

Manual Flush Bolt - Rounded Face Plate

- A flush bolt with radiused bottom faceplate designed specifically for simple one-step router installation.
- Double action spring design provides automatic holding of brass bolt in projected or retracted position, and assures ease of operation in conjunction with deep cup finger hole.
- Faceplate is polished solid brass; bolt is made from aluminum zinc alloy.
- Dimensions:
 Body Size: 3/4" Wide x 6" Long x 1-7/16" Deep
 Strike Size: 7/8" Wide x 1-3/4" Long
 Rod Backset: 1/2"
 Diameter of Bolt Head: 1/2"
 Throw: 1"



Stock No. (Specify Finish)

IV-265B

Finishes: 3, 26D

©ZIPF LOCK COMPANY

See page 427 for Cal Royal, Don Jo, Ives finish descriptions.

MISCELLANEOUS

GUN LOCKS

- The world standard in trigger lock design.
- Steel and zinc body for maximum durability.
- 4-pin tumbler cylinder helps prevent picking.
- Durable metal construction
- Protective rubber parts shield gun from scatching or marring.
- Fits many handguns, rifles and shotguns.

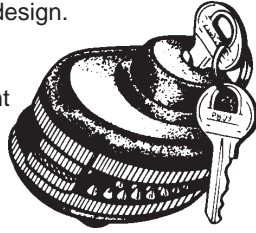

Master Lock



- Easy to install and set.
- Features positive locking with adjustable ratchet mechanism.
- Offers added convenience of a keyless resettable combination.
- Protective rubber parts shield gun from scatching or marring.
- Fits many handguns, rifles and shotguns.

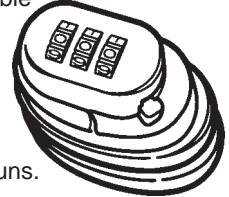

Keyed Different

90D

Keyed Alike*

90D KA

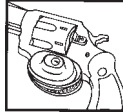

Resettable Combination

94DSPT

*KEYED ALIKE NUMBERS STOCKED:

90KA: P104.

HAND RAIL BRACKETS

CAL-ROYAL

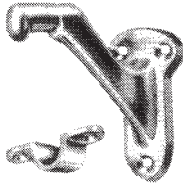

CR-HDHB40

US-3, 5, 10B, 15, 15A, 26, 26D
Heavy Duty Hand Rail Bracket
(2-1/4" H x 1-3/8"W)
(Ives #059)

DON-JO

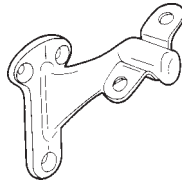

DJ-130

Finishes: 605, 609, 613, 619, 620, 625, 626

Material: Cast Aluminum. Base: 2-13/16" x 1-1/2". ANSI L33061.

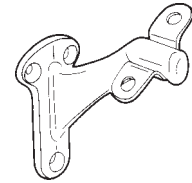

DJ-135

Finishes: 605, 613, 619, 620, 626
Material: Solid Brass. Base: 2-1/4" x 1-1/4". ANSI L13061.

IVES

Hand Rail Bracket

- 059 made from solid brass, cast aluminum or epoxy-coated aluminum.
- 59 made from cast brass or cast aluminum.
- Large faceplate for secure attachment to wall.
- Features solid construction for increased strength.
- 59 conforms to ANSI/BHMA A156.16 L13061 for brass and L33061 for aluminum.
- Dimensions:

IV-059A & IV-059B:

Base: 2-1/4" H x 1-3/8" W

Base to Center of Rail: 2-7/16"

IV-59A: Base: 2-13/16" H x 1-1/2" W

Base to Center of Rail: 2-3/4"

IV-59B: Base: 2-15/16" H x 1-1/2" W

Base to Center of Rail: 2-3/4"

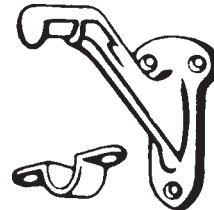

Stock No. (Specify Finish)

IV-059A Cast Aluminum

Finishes: 3, 5, 10B, 14, 92

IV-059B Solid Brass

Finishes: 3, 10B, 15, 15A, 26

Stock No. (Specify Finish)

IV-59A Cast Aluminum

Finishes: 3, 5, 10B, 14, 92

IV-59MB Cast Brass

Finishes: 3, 5, 10B, 15, 15A, 26, 26D

MISCELLANEOUS

HAND RAIL BRACKETS

Hand Rail Bracket

- For use on commercial applications.
- Exceeds OSHA and BHMA strength test requirements.
- Cast aluminum construction.
- Packed with toggle bolt and screws.
- Meets ANSI/BHMA A156.16, L33101.
- Dimensions:
3-1/8" Base Diameter
3-1/8" Base to Rail Center

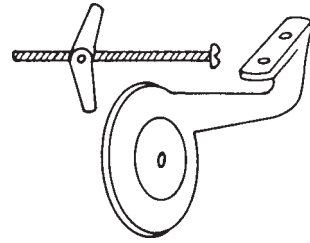

Stock No. (Specify Finish)
IV-HB158
Finishes: 3AL, 27

Hand Rail Bracket

- For use on commercial applications.
- Exceeds OSHA and BHMA strength test requirements.
- Packed with square head iron lag screw, expansion shield and screws.
- Cast Aluminum construction for the HB159A.
- HB159A meets ANSI/BHMA A156.16, L33081.
- Dimensions:
3-1/8" Base Diameter, 3-1/8" Base to Rail Center

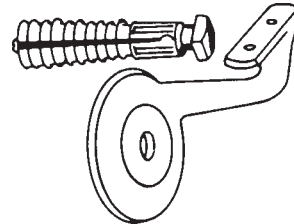

Stock No. (Specify Finish)
IV-HB159
Finishes: 3AL, 27

Adjustable Hand Rail Bracket

- For horizontal rail installations in institutional and commercial buildings.
- Rust resistant.
- Exceeds OSHA and BHMA strength test requirements.
- Adjustable brackets compensate for irregularities in wall, adjustable from 1-1/2" to 2" wall clearance.
- Stainless steel 1/4"-20 button head socket screw and stainless steel self-locking hex nut provide strong, rigid assembly.
- Extruded aluminum construction.
- Screws with expansion shields.
- Dimensions:
2-3/4" Tall x 1-3/4" Wide

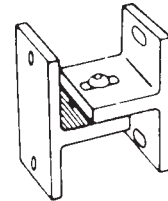

Stock No. (Specify Finish)
IV-HB162 28
Finishes: 28

HOOKS — COAT, HAT, ETC.

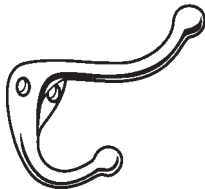

DON-JO

DJ-300
Finishes: 605, 613, 619, 620, 625, 626
Material: Cast Brass.

DJ-302
Finishes: 605, 613, 619, 620, 625, 626
Material: Cast Brass.



Stock No. (Specify Finish)
IV-571A
Finishes: 3, 92

Coat & Hat Hook

- All-purpose hook in traditional design.
- Made from cast aluminum.
- Conforms to ANSI/BHMA A156.16 L33113 for aluminum.
- Dimensions:
Base: 1-3/4" H x 1-1/4" W
Projection: 3"

©ZIPF LOCK COMPANY

See page 427 for Cal Royal, Don Jo, Ives finish descriptions.

MISCELLANEOUS

HOOKS — COAT, HAT, ETC.

Coat & Hat Hook

- Especially designed to accommodate large hats.
- Made from cast aluminum.
- Conforms to ANSI/BHMA A156.16 L33121.
- Dimensions:
Base: 2-1/4" H x 1-3/8" W
Projection: 3-5/8"
Overall Height: 5-3/4"



Stock No. (Specify Finish)
IV-575A3
Finishes: 3

Ceiling Hook

- Ideal for use in closets, attached to underside of shelves, or in storage lockers.
- Made from cast aluminum.
- Dimensions:
Base: 1" H x 1-7/8" W
Projection: 2-1/4"



Stock No. (Specify Finish)
IV-580A
Finishes: 3, 92

Wardrobe Hook

- Compact hook is perfect where space is limited, such as behind doors where low profile is needed.
- Made from cast aluminum.
- Dimensions:
Base: 1-1/4" H x 1-1/4" W
Projection: 1-5/8"



Stock No. (Specify Finish)
IV-581A
Finishes: 3, 92

Double Wardrobe Hook

- Compact double hook is perfect where space is limited, such as behind doors where low profile is needed.
- Made from cast brass or cast aluminum.
- Dimensions:
Base, Brass: 1-1/8" H x 1-1/4" W
Base, Aluminum: 1-1/16" H x 1-3/16 W
Projection, Brass: 1"
Projection, Aluminum: 1-3/32"

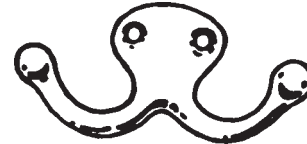

Stock No. (Specify Finish)
IV-582A Cast Aluminum
Finishes: 3, 92
IV-582MB Cast Brass
Finishes: 3, 5, 10B, 15, 15A, 26, 26D

KEY BLOK FOR LEVERS

Stock No	Description
A200 KD	Keyed Different
A200 KA	Keyed Alike

Portable! Light! Strong!

- Fits most lever handle locks.
- Prevents entry of any existing keys.
- Portable! Fits in the palm of your hand.
- Added protection! A new lock in just seconds.
- High strength aluminum alloy.
- **Silver Powdercoated Finish**

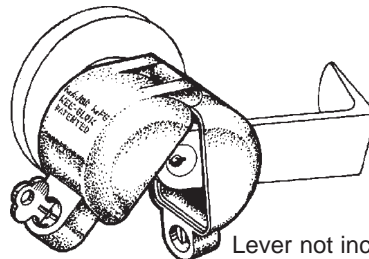

Lever not included

Blocks all existing keys to a lever handle in seconds!



FITS: Schlage Rhodes, Schlage Oly, Arrow Sierra, Sargent 10 Line Series, Falcon DG, Lockwood Lever, U.S. Lock, Cal Royal Appolo, LSDA Lever, S Parker Hardware, Sargent 6500 Series Lever, AND MANY OTHER MODELS

©ZIPF LOCK COMPANY

MISCELLANEOUS

HOUSE NUMBERS

Traditional House Numbers

- 4" High.
- Popular traditional styling for easy readability.
- Made from solid wrought brass.
- Conforms to ANSI/BHMA A156.16 L13181.
- Brass brads included.

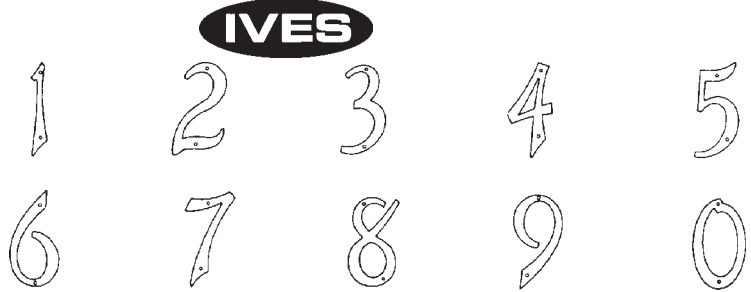

To Order, Specify Stock# & Finish

EX: IV-3004-619

Finishes: 605, 619, 620

Stock#	House Number	Stock#	House Number
IV-3004-	#0	IV-3054-	#5
IV-3014-	#1	IV-3064-	#6
IV-3024-	#2	IV-3074-	#7
IV-3034-	#3	IV-3084-	#8
IV-3044-	#4	IV-3094-	#9

Contemporary House Numbers

- 5" High.
- Bold, thick design is easy to see from a distance.
- Made from cast brass.
- Mounting screws included.

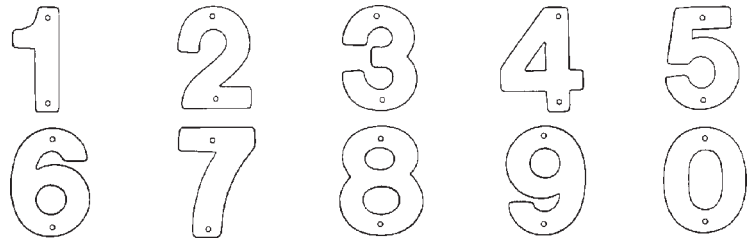

To Order, Specify Stock# & Finish

EX: IV-3005-619

Finishes: 505, 605, 613, 619, 620, 625

Stock#	House Number	Stock#	House Number
IV-3005-	#0	IV-3055-	#5
IV-3015-	#1	IV-3065-	#6
IV-3025-	#2	IV-3075-	#7
IV-3035-	#3	IV-3085-	#8
IV-3045-	#4	IV-3095-	#9

KEY BLOKS

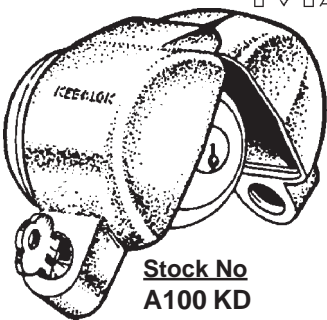

Stock No	Description
A100 KD	Keyed Different
A100 KA	Keyed Alike

- Prevents entry of any existing keys.
- Portable! Fits in the palm of your hand.
- Added protection! A new lock in just seconds.
- High strength aluminum alloy. Silver powdercoat finish.
- A100 fits 90% of all knob locks.

LETTER BOX PLATES



Sleeves for use with Letter Box Plates

- Made of stainless steel.
- For 1-3/4" hollow core doors.

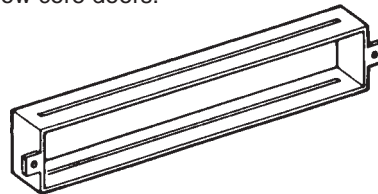

Stock No.	For Letter Box Plates:
IV-601 1-3/4	620, 621, 622 Plates
IV-602 1-3/4	618, 619, 623, 624 Plates

For use with Letter Box Plates on next page.

MISCELLANEOUS

LETTER BOX PLATES



Weather Tite®—

- Weather-Tite construction featuring interlocking flap and frame gives added protection from weather.
- 620 Series models feature spring loaded front plate features bronze spring to insure tightly closed position. Can be installed in vertical position.
- Rugged construction. Made of heavy gauge wrought brass, bronze or aluminum.
- Template for door cut-out packed with all letter box plates.

Magazine Size Letter Box Plate with Covered Back Plate

- Spring-loaded front plate.
- Dimensions: Overall Size: 13" x 3-9/16"
Plate Opening: 11" x 2"

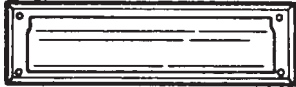

Stock No. Specify Finish)

IV-621B

Finishes: 3, 5, 10B, 15, 15A, 26, 26D

Letter Box Plate with Covered Back Plate

- Spring-loaded front plate.
- Dimensions: Overall Size: 10" x 3"
Plate Opening: 7-1/2" x 2"



Stock No. Specify Finish)

IV-624B

Finishes: 3, 5, 10B, 15, 15A, 26D

MAGNETIC CATCHES

Triple Pole Magnetic Catches

- Self-aligning magnet insures maximum pull.
- Case design allows easy magnet adjustment on cabinet or small door applications.
- Aluminum case.
- Packed with sheet metal screws.
- Conforms to ANSI/BHMA A156.9.
- Dimensions:
Case: 2-1/16" Long x 1-5/32" Deep x 7/8" Thick
Load Capacity: 6 lbs.

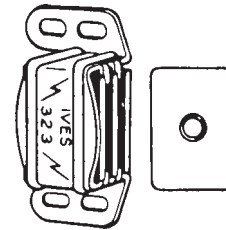

Magnetic Catch

IV-323A92

Finishes: Aluminum Clear Coated

Double Pole Magnetic Catches

- High impact plastic case is tan colored to blend with wood.
- Easy to adjust.
- Packed with sheet metal screws.
- Conforms to ANSI/BHMA A156.9 B03141.
- Dimensions:
Case: 1-3/4" Long x 9/16" Deep x 1/2" Thick
Load Capacity: 5 lbs.

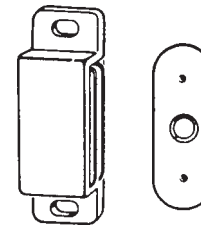

Magnetic Catch

IV-324P69

Finishes: Dark Bronze Painted

Double Pole Magnetic Catches

- Self aligning magnet insures maximum pull.
- Case design allows easy magnet adjustment on cabinet or small door applications.
- Aluminum case.
- Packed with sheet metal screws.
- Conforms to ANSI/BHMA A156.9.
- Dimensions:
Case: 2-1/16" Long x 1-1/8" Deep x 5/8" Thick
Load Capacity: 5 lbs.

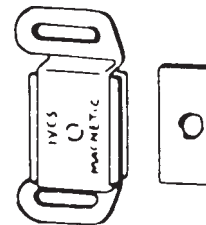

Magnetic Catch

IV-325A

Finishes: 3, 92

MISCELLANEOUS

MAGNETIC CATCHES

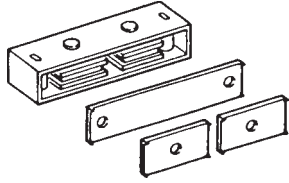

**Magnetic Catch
IV-326A**
Finishes: 3, 92

Mighty-Mite Heavy Duty Magnetic Catch

- Dual double pole.
- Self-aligning magnets insure maximum pull.
- Can be surface mounted or mortised.
- Aluminum case.
- Packed with sheet metal screws, 2 short strikes and 1 long strike.
- Conforms to ANSI/BHMA A156.9 B43161.
- Dimensions:
Case: 3-1/8" Long x 1" Deep x 9/16" Thick
Load Capacity: 9 lbs.

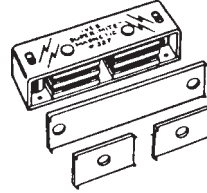

**Magnetic Catch
IV-327A**
Finishes: 3, 92

Super-Mite Heavy Duty Magnetic Catch

- Dual triple pole.
- Self-aligning magnets insure maximum pull.
- Can be surface mounted or mortised.
- Aluminum case.
- Packed with sheet metal screws, 2 short strikes and 1 long strike.
- Conforms to ANSI/BHMA A156.9 B43161.
- Dimensions:
Case: 3-1/8" Long x 1" Deep x 3/4" Thick
Load Capacity: 14 lbs.

PATIO DOOR LOCKS

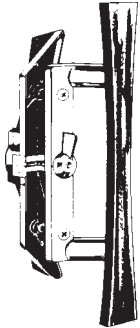

SURFACE MOUNTED PATIO SET

Very popular style. Handsome wood handle. Has internal latching. Is reversible for left or right hand application. Comes with various screw lengths to accommodate different door thicknesses.

V1104
VK1104 With Keylock



SURFACE MOUNTED PATIO HARDWARE — INSIDE HANDLE ONLY

Replaces the inside portion of the V1104 patio set. Installs easily with two attaching screws.

V1104IS



FLUSH MOUNTED PATIO SET

Most popular style. Is reversible for left or right hand application. Comes with seven different latches to meet all latching requirements. Easy installation.

V1195
VK1195 With Keylock



INSIDE HANDLE FOR V1195 SET

Handsome wood grained handle is designed for use with V1195 patio set. Wood screws are also included for use as a pull on large cabinet doors, etc.

V1147H

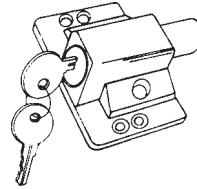

PATIO DOOR KEY LOCK

Key lock protection for inside or outside sliding door. Deadlocks door for maximum security. Easily locked by pushing bolt to engage. Requires key to unlock. Aluminum finish.

V104

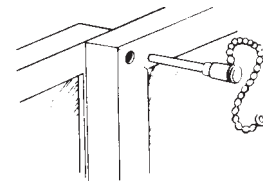

PATIO PIN LOCK

Install easily by drilling hole through sliding door and into one side of stationary door. Has pin holder for storage while not in use.

V108

Also see page 434 for Master's
Patio Door Locking Bar.

Also see page 251 for Major's
Octopod Lock.



Sliding Door Pin Lock MAG-8752

Prevents sliding and lifting of doors. Locks or vents.

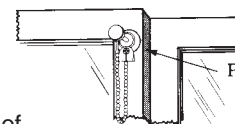

Pin Retainer Cap

©ZIPF LOCK COMPANY

See page 427 for Cal Royal, Don Jo, Ives finish descriptions.

MISCELLANEOUS

POCKET DOOR LOCKS & PULLS

CAL-ROYAL

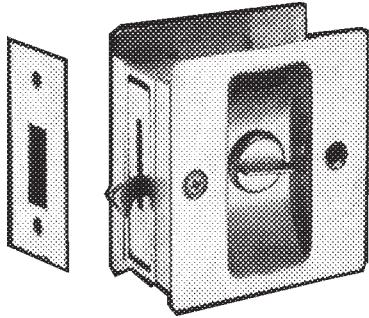

For Pocket Doors

- *Adjustable for 1-3/8" to 1-3/4" door thickness.
- Fully reversible.
- Simple to install.
- Individually polybagged & boxed.

*Privacy for 1-3/4" requires Rocker Pin-SPECIFY

Stock No.

SDL-16-

Description

Privacy Lock

SDL-17-

Passage Lock

•Privacy has emergency release.

FINISH: US3(605)

Bright Brass

5(609)

Antique Brass

15(619)

Satin Nickel

15A(620)

Antique Nickel

26(625)

Bright Chrome

26D(626)

Satin Chrome

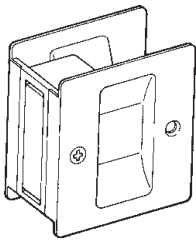

IVES

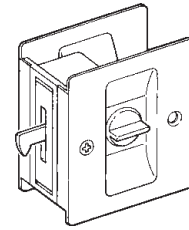
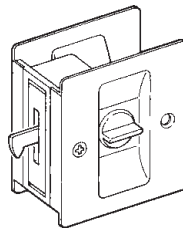

Stock No. (Specify Finish)

IV-990B

Finishes: 3, 5, 26, 613, 619, 620

Sliding Door Pull - Passage

- Fits doors 1-3/8" to 1-1/2".
- Decorative coined edges.
- Pre-assembled for doors opening left to right. Plates are reversible.
- Body and strike made from solid brass.
- Dimensions: 1-3/4" deep x 2-1/4" high

Stock No. (Specify Finish)

IV-991B

Finishes: 3, 5, 26, 613, 619, 620

Sliding Door Lock - Privacy

- Fits doors 1-3/8" to 1-1/2".
- Decorative coined edges.
- Pre-assembled for doors opening left to right. Plates are reversible.
- Body, turn knob and strike made from solid brass.
- Dimensions: 1-3/4" deep x 2-1/4" high

Stock No. (Specify Finish)

IV-992B

Finishes: 3

Sliding Door Lock - Double Sided

- Fits doors 1-3/8" to 1-1/2".
- Decorative coined edges.
- Pre-assembled for doors opening left to right. Plates are reversible.
- Body, turn knobs and strike made from solid brass.
- Dimensions: 1-3/4" deep x 2-1/4" high

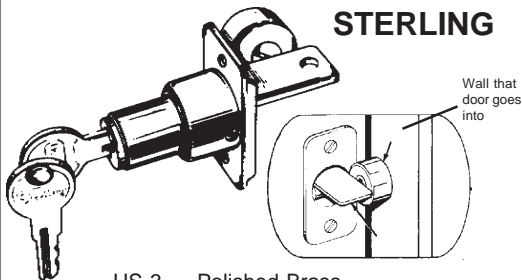

US-3 Polished Brass
US-26D Satin Chrome

Stock No

ST-1062

Finishes

US-3 or 26D

Keying

KD or KD

This sturdy lock provides a simple low-cost means of locking pocket doors. May be installed in almost any pocket door. All exterior surfaces are plated for good appearance. Quick and easy to install. No Mortising. Fits doors 1-3/8" to 1-3/4" thick. Jamb strike furnished. Two keys.

CAL-ROYAL

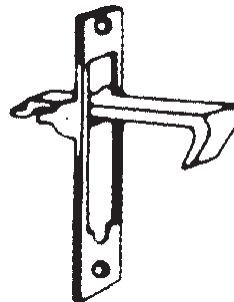

CR-EP23

US3

Edge Pull, Flush Mount, Size 3"

DON-JO

Edge Pull

DJ-104

Finishes: 605, 613, 626

Material: Solid Brass.

Dimensions: 3-7/8" x 3/4"



©ZIPF LOCK COMPANY

446 v1

(PL-42)

See page 427 for Cal Royal, Don Jo, Ives finish descriptions.

MISCELLANEOUS

POCKET DOOR LOCKS & PULLS



Sliding Door Edge Pull

- 3/4" width allows installation on narrow as well as standard doors.
- Spring automatically returns lever flush with plate.
- Made from solid brass.
- Conforms to design requirements of ANSI/BHMA A156.14 D2801.
- Dimensions: 3-7/8" H x 3/4" W

Stock No. (Specify Finish)

IV-230B

Finishes: 3, 5, 10B, 15, 15A, 26, 26D



Round Pocket Door Lock

- Fits standard 2-1/8" prep.
- Installs in minutes.
- Auto Catch Lock Mechanism.
- Lifetime Mechanical Warranty.
- 10-year Finish Warranty.

Stock No. Description

KW-334 Passage

KW-335 Privacy

Specify Stock No. and Finish.

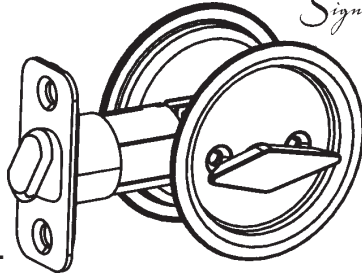

12 locks per case.

SPECIFICATIONS

DOOR THICK: 1-3/8" to 1-3/4"

BACKSET: 2-3/8"

BORE: 2-1/8" x 1"

FINISHES: **US-3** (605) Polished Brass

US-5 (609) Antique Brass

US-10B (613) Oil Rubbed Bronze

US-15(619) Satin Nickel

US-15A (620) Antique Nickel

US-26D (626) Satin Chrome

US-32 (629) Bright Stainless Steel

STORM DOOR LOCKS



Storm Door Latch

- For wood storm doors 7/8" to 1-1/8" thick.
- Reversible: fits right or left hand, inswinging or outswinging doors.
- Security lock feature operates from inside rose.
- Solid brass safety strike assures latching and is designed to compensate for air pressure build-up between doors.
- Made from wrought brass.
- Dimensions:
Backset: 1-3/4"
Rose Diameter: 1-7/8"
Knob Diameter: 1-3/4"
Knob Projection: 2"
Lever Length: 1-3/4"
Lever Projection: 1-7/8"

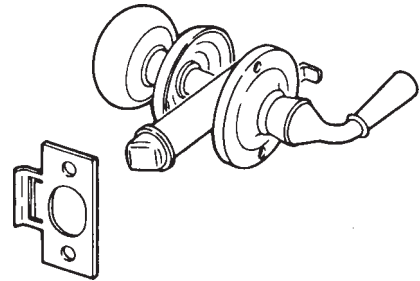

Stock No. (Specify Finish)

IV-980B

Finishes: 3, 5, 10B, 15, 15A, 26, 26D

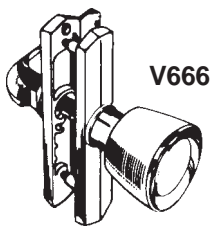

TULIP KNOB LATCH

- For outswinging wood or metal doors.
- Fits doors 7/8" to 1-1/8" thick.
- Installation hole spacing 3".
- Installs in three 1/4" holes.
- Backset from jamb (door stop) 1".

- Installs with spring loaded strike plate.
- Covers most previous installation drillings in door.

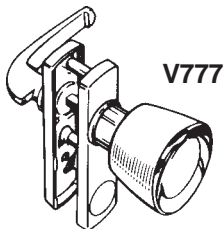

TULIP KNOB LATCH

- For outswinging wood or metal doors.
- Fits doors 7/8" to 1-1/8" thick.
- Installation hole spacing 1-3/4".
- Installs in three 1/4" holes.
- Backset from jamb (door stop) 7/8".
- Installs with spring loaded strike plate.



©ZIPF LOCK COMPANY

See page 427 for Cal Royal, Don Jo, Ives finish descriptions.

447
(PL-42)

MISCELLANEOUS

WINDOW HARDWARE



Window Lock

- Spring actuated lever provides positive direct pull which pulls rails together.
- Stops rattles and drafts.
- When unlocking, lever automatically returns to opened position.
- Made from wrought steel.
- Meets design requirements of ANSI/BHMA 156.16.
- Dimensions: Base: 1-3/8" x 2-5/16"; Strike: 9/16" x 2-1/4"

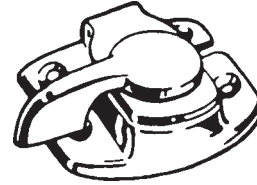

Stock No. (Specify Finish)

IV-4F3

Finishes: 3

Window Lock

- Designed low to the sash for superior strength and greater resistance to breakage.
- Vertical and horizontal camming action for snug, non-rattling fit.
- Heavy gauge springs provide long-wearing action.
- Made from solid brass or aluminum.
- Meets design requirements of ANSI/BHMA 156.16.
- Dimensions:
Base: 15/16" x 2-9/16"
Strike: 5/8" x 2-9/16"

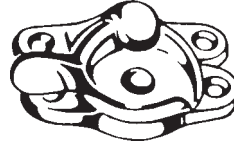

Stock No. (Specify Finish)

IV-07A3 Aluminum

Finishes: 3

IV-07MB Solid Brass

Finishes: 3, 10B, 15, 15A, 26

Bar Window Lift

- Facilitates opening of window in a safe manner.
- Can also be used as a drawer or utility pull.
- Made from solid brass or aluminum.
- Meets ANSI/BHMA A156.16.
- Dimensions:
Base: 1-1/8" x 4"
Projection: 1-1/16"



Stock No. (Specify Finish)

IV-026A3 Aluminum

Finishes: 3

IV-026MB Solid Brass

Finishes: 3, 14

Casement Fastener (2 sizes)

- For use on windows to provide weather-tight fastening and security.
- Also ideal for securing louvered doors and small doors.
- Made from solid brass or aluminum.
- Meets ANSI/BHMA A156.16.
- Dimensions:

IV-066

Base: 1-5/8" x 7/8"

Projection: 1-3/8"

IV-66

Base: 2-1/16" x 1-1/16"

Projection: 1-7/8"

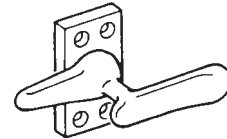

Stock No. (w/rim & mortise strikes)

IV-66A3 RS MS Aluminum

Finishes: 3

Stock No. (w/mortise strike)

IV-66B * MS Solid Brass

Finishes: 3, 10B, 15, 15A, 26, 26D

Stock No. (w/rim strike)

IV-66B * RS Solid Brass

Finishes: 3, 10B, 15, 15A, 26, 26D

Stock No. (w/surface strike)

IV-66B * SS Solid Brass

Finishes: 3, 10B, 15, 15A, 26, 26D

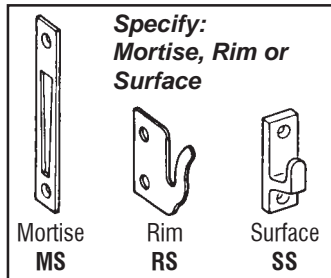

Stock No. (w/rim & mortise strikes)

IV-066A3 RS MS Aluminum

Finishes: 3

Stock No. (w/mortise strike)

IV-066B * MS Solid Brass

Finishes: 3, 10B, 15, 15A, 26, 26D

Stock No. (w/rim strike)

IV-066B * RS Solid Brass

Finishes: 3, 10B, 15, 15A, 26, 26D

Stock No. (w/surface strike)

IV-066B * SS Solid Brass

Finishes: 3, 10B, 15, 15A, 26, 26D

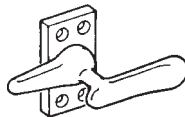

MISCELLANEOUS

WINDOW HARDWARE



Casement Adjuster

- Securely holds casement window in any position.
- Can also be used to hold cabinet lids and drafting table tops in various positions.
- Made from burnished steel or solid brass.
- Available in 10" and 12" lengths.
- Dimensions: Tube: 3/8" x 5/8"; Projection: 1"
Sash Plate: Brass: 1-5/8" x 5/8"; Steel: 2 x 5/8"
Sill Plate: 2-1/4" x 15/16"



Stock No. (Specify Finish & Length)

IV-71B3 10"	Length 10" - Brass
IV-71B3 12"	Length 12" - Brass
Finishes: 3	
IV-71F3 10"	Length 10" - Steel
IV-71F3 12"	Length 12" - Steel
Finishes: 3	



Transom Catch

- Independent latch action; transom can be closed by pushing directly on ring.
- Reversible: latch bolt can be easily reversed by removing back plate.
- Narrow base accommodates 1-1/4" rail.
- Made from cast aluminum.
- Conforms to design requirements of ANSI/BHMA A156.16.
- Dimensions:
Size: 2-1/4" x 1-1/4"
Latch Throw: 5/16"

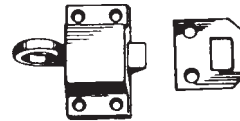

Stock No. (Specify Finish)

IV-80A4 US	Universal Strike
Finishes: 4	

Transom Chain

- Available in 10", 12" (15" special order) chain lengths to meet varying opening requirements and transom sizes.
- Made from wrought steel.
- Plate Size: 1-1/2" x 1".

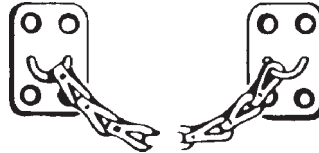

Stock No. (*Specify Finish & Length)

IV-82F * 10"	Length 10"
*Finishes: 3, 14	
IV-82F * 12"	Length 12"
*Finishes: 3, 14	



HEAVY DUTY

For door or window. 2 per card.
MAG-8732 Aluminum



HEAVY DUTY

Fits wide or narrow tracks.
No-Mar, 2 per card.
MAG-8746 Aluminum

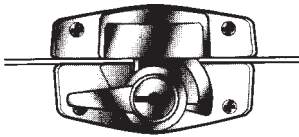

KEYED WOOD SASH WINDOW LOCK

MAG-8758 KA Brass

For double hung wood windows

PUSH/PULL/KICK PLATES

KICK PLATES

COMMERCIAL KICK PLATES—

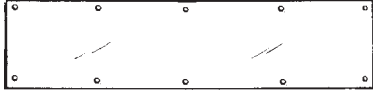

.050 Metal (BT finish .040).
ANSI J102

DON-JO

- Individually Packaged with screws.
- Full threaded to the head stainless steel sheet screws with plated finish.
- Commercial grade thickness.

Stock No.	Finishes	Size
DJ-90 6X28	605	6" x 28"
DJ-90 6X30	605, 609, 613, 619, 620, 628, 629, 630, BT, DB	6" x 30"
DJ-90 6X34	605, 609, 613, 619, 620, 628, 629, 630, BT, DB	6" x 34"
DJ-90 8X28	605, 630	8" x 28"
DJ-90 8X30	605, 609, 613, 619, 620, 628, 629, 630, BT, DB	8" x 30"
DJ-90 8X34	605, 609, 613, 619, 620, 628, 629, 630, BT, DB	8" x 34"
DJ-90 10X34	605, 613, 628, 630	10" x 34"

• See previous page for finish descriptions.

KICK PLATES

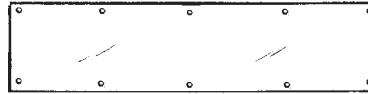

Residential Kick Plate - .037" Thickness

- All plates are .037" thick.
- The majority of kick plates are carded. Some are packaged in strong kraft paper.
- Selected sizes and finishes available in magnetic form for easy installation on hollow metal doors.
- Each non-magnetic plate is packed with #6 x 5/8" oval head, undercut sheet metal screws plated to match, for installation on hollow metal, laminate or wood doors.

Stock No.	Size	*Finishes
8400B * 6X30	6" x 30"	3, 5, 505, 613, 619, 620, 625
8400B-605 RG630MAG	6" x 30"	605
8400PA * 6X30	6" x 30"	3, 28
8400B * 6X34	6" x 34"	3, 5, 505, 613, 619, 620, 625
8400B-605 RG634MAG	6" x 34"	605
8400PA * 6X34	6" x 34"	3, 28
8400B3 8X30	8" x 30"	3
8400PA * 8X30	8" x 30"	3, 28
8400B * 8X34	8" x 34"	3, 5, 505, 613, 619, 620, 625
8400B3 8X34MAG	8" x 34"	3
8400B-505 RG8X34MAG	8" x 34"	505
8400PA * 8X34	8" x 34"	3, 28
8400PA3 8X34 MAG	8" x 34"	3

*Specify Finish.
MAG-Magnetic Kick Plate.

- SPECIAL NOTES—**
- * -Specify Finish.
 - MAG** -Magnetic Kick Plate. Stainless Steel or Solid Brass Material.
 - PA** -Aluminum Material.
 - 505** -Stainless Steel Material- Lifetime Brass Finish
- Balance of finishes are Solid Brass Material

Magnetic Kick Plates Available

Ives Finishes:

- US-3** Bright Brass, clear coated
- US-5** Antique Brass, clear coated
- US-28** Satin Aluminum, clear anodized.
- 605** Polished Brass
- 505** Polished Brass-Lifetime
- 613** Oil Rubbed Bronze
- 619** Satin Nickel, clear coated
- 620** Antique Nickel, clear coated
- 625** Bright Chrome

Commercial Kick Plates - .050" Thickness

- Door Protection Plates are fabricated from the finest architectural aluminum, brass, and stainless steel.
- All aluminum, brass, bronze and stainless steel Door Protection Plates meet ANSI A156.6 requirements for .050" thickness.
- Each plate is packaged carefully wrapped in strong kraft paper with #6 x 5/8" oval head, undercut sheet metal screws plated to match, for easy installation on hollow metal, laminate, or wood doors.
- Use No. 8401 Kickplate Gasket Tape (*Special Order*) as a buffer between brass kickplates and metal doors to help prevent tarnishing which may result from electrolytic oxidation. One package provides enough double-sided adhesive-backed foam tape for the perimeter of an 8" x 34" plate.

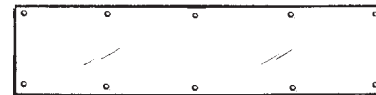

Stock No.	Size	*Finishes
8400B * 6X34 050	6" x 34"	3, 5
8400B * 8X34 050	8" x 34"	3, 5

*Specify Finish.

Other sizes from 4" x 22" to 48" x 48" available by special order.

©ZIPF LOCK COMPANY

STRIKES



WELDABLE GATE BOXES

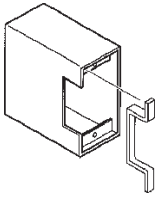

KD-K-BXES1

For installing Trine 005 and Rofu 1106 electric strikes.

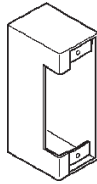

KD-K-BXES2

For installing Rofu 1402, 1702 and 3402 electric strikes. Also Rutherford 7 Series.

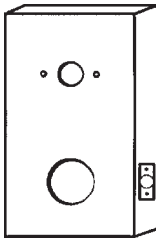

KD-K-BXSIM

For installing Simplex/Unican 1000 Series.



Stock No.

MAG-747-3

Finish

Brass

The ONLY strike to use when installing deadbolts.

- For use with any deadbolt. (Box is 1-5/8" high x 3/4" wide x 1-1/4" deep).
- Standard ASA 1-1/4" x 4-7/8".
- One piece construction.
- Secured by 4—2" long hardened screws.
- 2 screws at bottom of box are offset and installed at a 25° angle allowing screws to enter the stud closer to the center for maximum holding strength. Prevents bolts from being pushed in with punch.
- Box made of heavy 16 gauge steel.

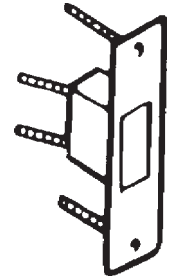

ADJUST-A-STRIKE

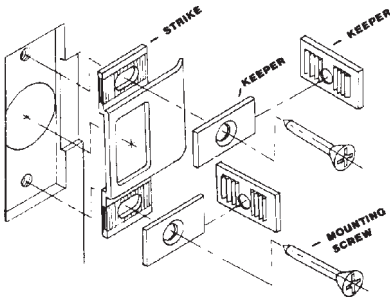

This strike eliminates door rattle, bind on lock bolt, and provides for a snug fit against weather-strip for energy conservation.

Stock No.

MAG-450-B

Finish

Brass

2-3/4" x 1-1/4" Lip Strike

Stock No.

MAG-454-C

Finish

Chrome

4-7/8" x 1-1/4" Lip Strike For Metal Frame

Stock No.

MAG-721-B

Finish

Brass

Large Lip Strike with 2" screws.(4-7/8" x 1-1/4").

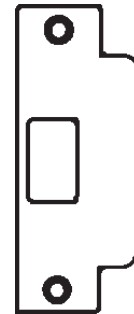
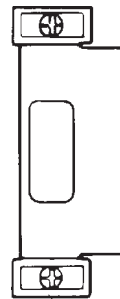

progressive

SECURITY STRIKES

- Heavy gauge steel.
- Brass plated.
- Supplied with 1-1/2" screws.
- Individual poly bagged.



PG-9620

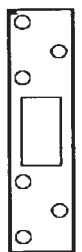

PG-9630

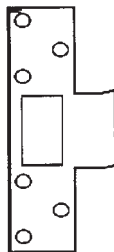

PG-9640

Stock No.

PG-9620

Size

10" x 1-1/4"

PG-9630

5-7/8" x 1-1/8"

PG-9640

5-7/8" x 1-1/8"

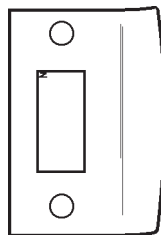

\$PG-73

Passage Strike-Curved Lip Brass Plated

\$-Discontinued. Call for closeout prices

IVES

FLUSH BOLT STRIKE—

Dust Proof Strikes - Threshold Only

- Designed for use with the bottom bolt of the Ives extension flush bolts on non-fire rated openings. For installation in thresholds up to 1/4" thick.
- 3/4" diameter plunger accepts up to 5/8" diameter round bolts or 1/2" square bolts.
- Can be locked in up position by rotating plunger with screwdriver or coin. Eliminates trapping of spiked heels.
- Made from polished wrought brass.
- Dimensions:
Faceplate: 1-3/8" Diameter
Body: 1-61/64" Overall Depth,
Fits Hole 1-1/16" in Dia.

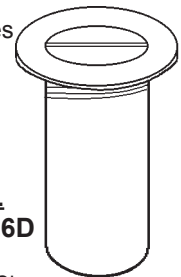

Stock No.

IV-DP3 26D

Finish:

26D Satin Chrome