

EXIT DEVICES

S1250

Rim Exit Device

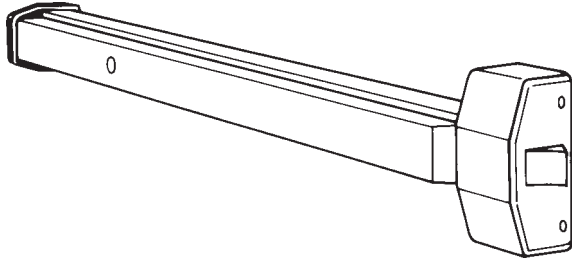

<u>Stock No.</u>	<u>Finish</u>
AR-S1250 AL	Powder Coat Aluminum
AR-S1250 BRZ	Powder Coat Bronze

Specifications

Conforms to ANSI A156.3 Type 1 Grade 1

For Doors	Wood or hollow metal 1-3/4" thick.
Stile	4-1/2" minimum stile.
Covers	Nonferrous alloy.
Chassis	Nonferrous alloy.
Rail Assembly	Steel. Furnished standard for doors 32" to 36".
End Cap	Metal.
Hand	Non handed.
Latch Bolt	3/4" throw stainless steel.
Strike	S38 strike, surface applied, standard for S1250. Not for fire exit hardware.
Dogging Feature	Hex key dogging standard. Cylinder dogging special order only.
UL/CUL Listed	For panic, standard.
Cylinder	Brass Material. SR & TA trim supplied standard with cylinder.
Finishes	AL - Powder Coat Aluminum BRZ - Powder Coat Bronze



S1250

Rim Exit Device Trims

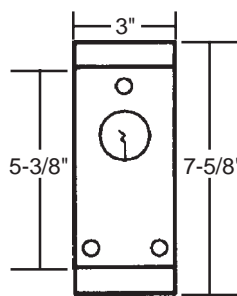

Trim is furnished with mortise nuts and screws for 1-3/4" doors. Covers 161 cutout.

<u>DESCRIPTION</u>	<u>Stock No.</u>	<u>Finish</u>
Blank Plate(no pull)	AR-SF01	AL
Pull w/o cyl. or hole	AR-SF02	AL or BRZ
Pull <u>with</u> cylinder	AR-SF12	AL or BRZ

•Specify Stock No. and Finish when ordering.



<u>DESCRIPTION</u>	<u>Stock No.</u>	<u>Stock No.</u>
Passage	—	AR-SR01
Storeroom	AR-TA12	AR-SR12
Storeroom-IC	—	AR-SR12-IC
Classroom	AR-TA17	AR-SR17
Classroom-IC	—	AR-SR17-IC

•Available in 26D-Dull Chrome finish only
IC=Interchangeable core. Furnished less core.

DON-JO

PULL PLATE FOR S1250

DJ-7015 ARROW 630

Stainless steel finish. Pull with cylinder hole. Cylinder not included. Plate is 3" x 13-1/2"

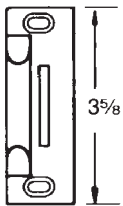
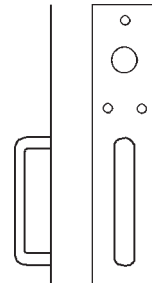

The S38 strike is the standard strike that is included in the S1250 Rim Exit Device.

Surface Applied
Nylon Coated

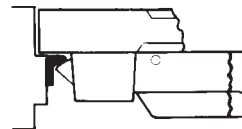

Minimum Stile Requirements
Single Door

4-1/2" MIN. STILE

©ZIPF LOCK COMPANY

EXIT DEVICES

NARROW STILE SURFACE VERTICAL ROD EXIT DEVICES - 8200 SERIES



- For aluminum doors.
- ANSI/BHMA A156.3 Grade 1.
- Patented top latching mechanism interlocks door to frame.
- Adjustable steel rods protected in contour covers.
- Pushbar clad or anodized, not plated, finish.
- Easy to install.
- Clean, unobtrusive design.
- Strong, durable construction for high level of security.

Stock No. AR-8222-36 313 **Finish** Dark Bronze Anodized



Handing: Device is non-handed. **Pushbar Length:** For 36" doors. Can be cut for 30" doors. **Bar Height:** Adjust from 30" to 44". **Door Height:** Fits up to 8ft. door with bar height at 40" - 44". **Door Thickness:** For 1-3/4" thick doors. **Stile Width:** Minimum 2" stile. Fits narrow, medium and wide stile aluminum doors. **Projection:** 2-15/16" when fully projected. 1-15/16" when dogged. **Dogging:** Standard dogging with hex key. **Materials:** Pushbar made of extruded aluminum, clad or anodized finish. **Fasteners:** Standard self-tapping screws. **Strike:** Made of hardened steel. Supplied. **Warranty:** 2-year limited warranty.



Standard Strike

NARROW STILE MORTISE EXIT DEVICES - 8400 SERIES

- For wood or hollow steel doors.
- ANSI/BHMA A156.3 Grade 1.
- Heavy duty deadlatching mechanism.
- Pushbar clad or anodized, not plated, finish.
- Easy to install.
- Clean, unobtrusive design.
- Strong, durable construction for high level of security.



<i>628-Aluminum Finish</i>				<i>313-Bronze Finish</i>			
<u>Stock#</u>	<u>Backset</u>	<u>Hand</u>	<u>Width</u>	<u>Stock#</u>	<u>Backset</u>	<u>Hand</u>	<u>Width</u>
AR-8410-27136	31/32"	RHR	36"	AR-8420-28236	31/32"	LHR	36"
AR-8410-28136	31/32"	LHR	36"	AR-8420-38236	1-1/8"	LHR	36"
AR-8410-37136	1-1/8"	RHR	36"	AR-8420-38242	1-1/8"	LHR	42"
AR-8410-38136	1-1/8"	LHR	36"				

• Designed to fit standard cutout used for the Adams Rite MS® Deadbolt on aluminum stile glass doors •

Handing: Specify handing and bevel if applicable. **Pushbar Length:** For 36" doors. Can be cut for 30" doors. **Door Thickness:** For 1-3/4" thick doors. **Stile Width:** Minimum 2" stile. Fits narrow, medium and wide stile aluminum doors. **Projection:** 2-5/8" when fully projected. 1-5/8" when dogged. **Dogging:** Standard dogging with hex key. **Materials:** Pushbar made of extruded aluminum, clad or anodized finish. **Fasteners:** Standard self-tapping screws. **Strike:** Made of stainless steel. Supplied. **Warranty:** 2-year limited warranty.

EXIT DEVICES

NARROW STILE CONCEALED VERTICAL ROD EXIT DEVICES - 8600 SERIES



- For aluminum doors.
- ANSI/BHMA A156.3 Grade 1.
- Patented top latching mechanism interlocks door to frame.
- Top and bottom adjustable steel rods.
- Pushbar clad or anodized, not plated, finish.
- Easy to install.
- Clean, unobtrusive design.
- Strong, durable construction for high level of security.

Stock No. AR-8622-36 313 **Finish** Dark Bronze Anodized



Handing: Device is non-handed. **Pushbar Length:** For 36" doors. Can be cut for 30" doors. **Bar Height:** Adjust from 30" to 44". **Door Height:** Standard unit adjustable for doors up to 66" above the selected bar height. **Door Thickness:** For 1-3/4" thick doors. **Stile Walls:** Doors with stile walls other than 1/8" require modification. **Stile Width:** Minimum 2" stile. Fits narrow, medium and wide stile aluminum doors. **Projection:** 2-5/8" when fully projected. 1-5/8" when dogged. **Dogging:** Standard dogging with hex key. **Materials:** Pushbar made of extruded aluminum, clad or anodized finish. **Fasteners:** Standard self-tapping screws. **Strike:** Made of hardened steel. Supplied. **Warranty:** 2-year limited warranty.



NARROW STILE RIM EXIT DEVICES - 8800 SERIES

- For aluminum doors.
- ANSI/BHMA A156.3 Grade 1.
- Patented "Starwheel" bolt interlocks door to frame.
- Pushbar clad or anodized, not plated, finish.
- Easy to install.
- Unobtrusive design for clean sight lines.
- Strong, durable construction for high level of security.



Stock No. AR-8801-36 **Finish** Satin Aluminum
 AR-8801-36-CD **Finish** Satin Aluminum
 AR-8802-36 **Finish** Dark Bronze Anodized
 AR-8802-36-CD **Finish** Dark Bronze Anodized

Handing: Device is non-handed. **Pushbar Length:** For 36" doors. Can be cut for 30" doors. **Bar Height:** Adjust from 30" to 44". **Door Thickness:** For 1-3/4" thick doors. **Stile Width:** Minimum 2" stile. Fits narrow, medium and wide stile aluminum doors. **Projection:** 2-5/8" when fully projected. 1-5/8" when dogged. **Dogging:** Standard dogging with hex key or optional cylinder dogging. **Materials:** Pushbar made of extruded aluminum, clad or anodized finish. **Fasteners:** Standard self-tapping screws. **Strike:** Made of hardened steel. Standard and narrow version supplied. **Warranty:** 2-year limited warranty.

"CD" Cylinder dogging for non rated exit devices. For management control of dogging. Any standard 15/16" to 1-1/8" long mortise cylinder with MS® cam can be used in a pushbar prepared at the factory with cylinder dogging kit.

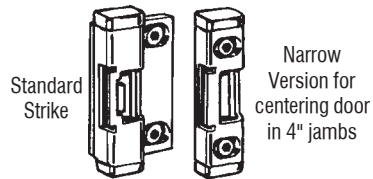

EXIT DEVICE PARTS

DOGGING KEYS FOR ADAMS-RITE EXIT DEVICES

 **AR-25-0052** Replacement spindle

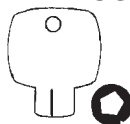

AR-25-0480 Plastic



AR-29-0480 5/32" key size
AR-29-0481 1/8" key size



AR-25-0471



AR-41-0801-01



AR-41-0801-08

Replacement End Caps

AR-25-0471 For inactive end of 8400/8600/8800 bars.
AR-41-0801-01 For active end of 8400/8600 bars.
AR-41-0801-08 For active end of 8800 bars.

EXIT DEVICES

PILFERGARD PG-10

- Mini-Burglar Alarm.
- Low-Cost.
- Twin Action Horns.
- Easily Installed.



ALARM LOCK

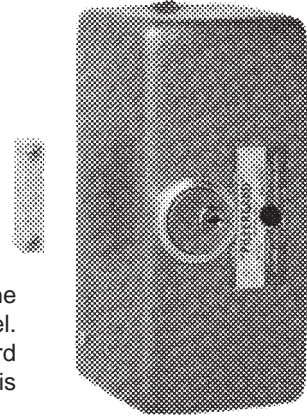

AK-PG-10

Stock No. **Finish**
AK-PG-10 Metallic Silver

The Pilfergard model AK-PG-10 is an exit door alarm designed to deter the use of the secured door by sounding a twin action alarm when opened by unauthorized personnel. The alarm can be bypassed from inside or outside by use of a key. (Requires standard mortise cylinder not supplied.) This durable surface mount unit is easily installed and is tamper-supervised with two separate tamper switches. Its test button verifies battery.

SIRENLOCK™

- Narrow stile door alarms.
- Convenient plug-in No-Cut jumpers.
- Improved 95db sweeping siren.
- Visual magnetic alignment mode, eliminates templates.
- Self-contained and dual-tamper supervised.
- 9v-battery powered (supplied) with low battery alert.

Stock No **Finish**
AK-PG-21 MB Duronodic
AK-PG-21 MS Metallic Silver

Sleek model design key-activated door alarm for use on standard size and narrow stile doors. Unauthorized use of door will cause alarm to sound and will activate the LED indicator. User selectable options include: continuous alarm, minute shutdown with auto reset and exit/entry delay. Only key carrying employees can disable the alarm; uses standard mortise cylinder (not included). (For exterior key control, an optional RIM cylinder may also be used.) Finishes: metallic silver or Duronodic.

Cylinder pictured
NOT included

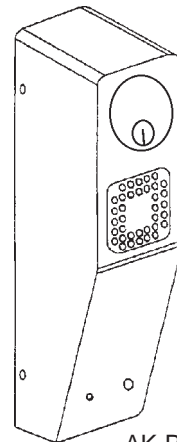

AK-PG-21

EXIT DEVICES

SIRENLOCK™

- Deadbolt & Deadlatch meet relatching requirements.
- Free retrofit cover plates conceal mounting holes from models 11A and 230.
- Blaring 95db dual tone piezo siren.
- Selectable 2-minute alarm or constant alarm.
- 9V battery Powered & audible low battery warning.
- Meets or exceeds UL, CFM, ADA, NYC Housing.

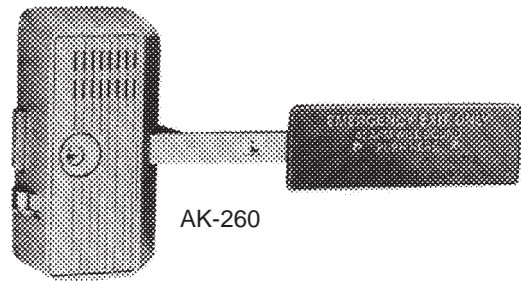

AK-260

Stock No.

AK-260 MS Changeable 2-minute auto reset or manual reset. Model 260 is a UL Listed panic alarm deadbolt device which restrict unauthorized use of exit doors by sounding an alarm, while providing instant egress in emergencies. High security deadlatch and deadbolt for extra protection.

Stock No.

AK-700 MS Changeable 2-minute alarm cutoff or manual reset.
AK-710 MS Changeable 2-minute auto reset or manual reset. Models 700 & 710 are UL Listed panic alarm deadbolt devices which restrict unauthorized use of exit doors by sounding an alarm, while providing instant egress in emergencies. High security deadlatch and deadbolt for extra protection.

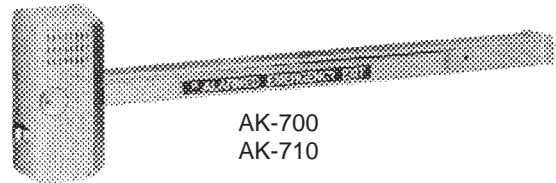

AK-700
AK-710

SIRENLOCK™ w/DELAY

<u>Stock No.</u>	<u>Finish</u>
AK-715 US28	Metallic Silver
AK-715 US312	Duranodic

Features:

- 15-Second delayed egress with instant 95db dual piezo horn alarm (Meets UL specifications).
- Instant alarmed exit in case of actual emergency or fire (Meets NFPA 1012 Life Safety Code).
- Monitoring output for simultaneous use of CCTV camera, secondary siren, remote monitoring console, etc.
- Smoke detector input can be used to power existing system's or stand-alone smoke detector(s). (includes armored door cord and cables for wiring)
- 9-Volt battery back-up powers siren in event of power failure.

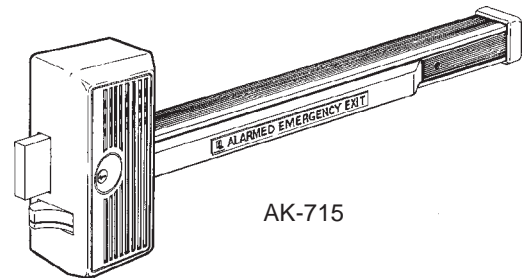

AK-715

Easy-to-install, surface mount unit in a standard panic bar deadbolt/deadlatch design

EXIT DEVICES

ACCESSORIES



ALARM LOCK

Battery Pack (6-Volt) *Not Shown.*

AK-BP6

For use with: Models AK-PG-10, 11A and PG20.

Outside Access Door Pull

AK-707 MS Metallic Silver Finish

For access from building exteriors. Installed on the outside of the door and linked to the lock. After deadbolt is retracted by outside key, a slight pull will release the deadlatch and open the door. 8" x 1-1/2". (For use with all models except AK-11A).

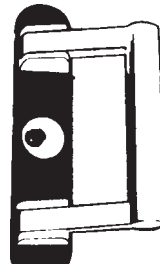

AK-707



AK-711

Cylinder Finger Pull

AK-711 MS Metallic Silver Finish

For use with: Models AK-11A, 250, 260, 700 and 710. An inexpensive door pull for use when outside key only access is required.

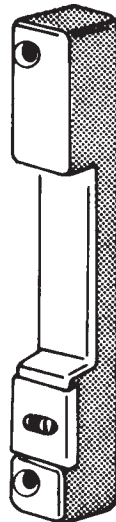

AK-732

Double Door Strike

AK-732

FINISHES: US28-Aluminum

For use with models 250, 700 and 80.

EXIT DEVICES

9800 SERIES EXIT DEVICES

- Rim Type Exit Device
- ANSI A156.3 Grade 1, UL & ULC Listed
- 1-year Mechanical Warranty

CAL-ROYAL

9800EO—

- Rail assemblies and end caps are brass, bronze or stainless steel and rail travels in direction of the door swing.
- Trims are thru bolted for additional security.
- Chassis mounted unit construction. Rim and vertical rod devices are nonhanded and easily reversible.
- Lever and escutcheon trims are grade 1 construction with clutch freewheeling mechanism. Rose and escutcheon covers 161 cut out.

SPECIFICATIONS—

- **FOR DOORS:** For 1-3/4" door thickness. 4-1/2" minimum stile width required for single or double door applications using standard 239 strike and pull or lever, thumbpece and escutcheon trims.
- **CHASSIS:** Nonferrous alloy.
- **COVER:** Brass, bronze or stainless steel. Covers stock hollow metal doors with 161 cutout.
- **MOUNTING:** Furnished with wood and machine screws.
- **END CAP:** Brass, bronze or stainless steel construction.
- **ALARM:** Available.
- **HAND:** Non handed, center hub.
- **LATCHBOLT:** Stainless steel 3/4" throw.
- **SPRING:** Stainless steel throughout.
- **ANSI STANDARD:** A156.3, Grade 1.
- **RAIL ASSEMBLY:** Heavy gauge brass, bronze or stainless.
- **STRIKE:** 239 packed standard.
- **DOGGING FEATURE:** Allen-type key furnished standard.
- **MULLION:** Special order.
- **DOOR SIZE:** 9800EO36 for 36" doors. (2'9" to 3' doors)
- **CENTER CASE:** 8-1/2" x 2-1/2" x 2"

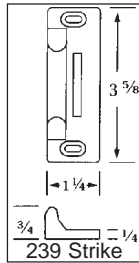

9860V 3684—Same as above unless listed below.

- **FOR DOORS:** For 1-3/4" door thickness. 3-3/4" minimum stile width required for single door applications. 3-1/2" minimum stile width for double door applications.
- **ALARM:** Available by special order.
- **HAND:** Easily field reversible. Specify LHRB or RHRB for convenience.
- **LATCHBOLT, SPRING:** Stainless steel.
- **DOOR SIZE:** 9860V 3684 for 36" x 84" doors. (2'9" to 3' doors)
- **STRIKES:** 221 & 227 packed standard.
- **TOP AND BOTTOM RODS:** Top rod 43-1/4", bottom rod 37-3/4".
- **VERTICAL RODS:** 1/2" round tubing.
- **TOP AND BOTTOM CASES:** 3-15/16" x 2-1/8" x 1-3/8".

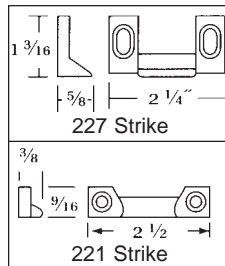

ALARM EXIT HARDWARE—

Alarm units has an internal horn. When the push rail is depressed, the horn sounds to provide an audible means of signaling that the door has been opened and violated.

The unit has changeable 2 minute alarm cutoff or manual reset. Preset at the factory for 2 minute alarm cutoff. Jumper cable is provided to switch to continuous alarm.

The key switch to turn the alarm off is a standard 1-1/4" cylinder with "C" keyway. The alarm operates on one standard 9 volt transistor battery. When battery is weak the horn will emit an intermittent signal.

Alarmed units are supplied with two switches. One switch monitors the push rail and the other switch monitors the latchbolt for full proof security.

Unit includes "EMERGENCY EXIT ONLY ALARM WILL SOUND" decals for application on door or unit.



9800EO 36"

Also stock Vertical Bar (9860V 3684)



ALRM9800EO 36"

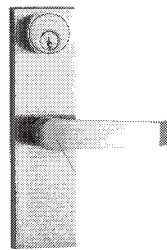

**Clutch Freewheeling
ESC9800 Entrance
ESC9830 Passage**



**98TP00
Entrance
2-5/8"x15"**



**9800DTP
2-5/8"x15"**



**9800NL
2-5/8"x15"**

Stock No.
9800EO 36"
9860V 3684
ALRM9800EO 36"

Description
Exit Only
Vertical Bar-Exit Only
Exit Only w/alarm

98TP00
9800DTP
9800NL
ESC9800
ESC9830

Exterior Trim-see above
Exterior Trim-see above
Exterior Trim-see above
Exterior Trim-see above
Exterior Trim-see above

TO ORDER, SPECIFY:

FOR BAR-

Stock No. and Finish

Finishes:
US-3 Bright Brass
US-10B Oil Rubbed Bronze
US-32D Stainless Steel

FOR TRIM-

Stock No. and Finish

Finishes:
US-3 Bright Brass
US-10B Oil Rubbed Bronze
US-26D Satin Chrome

EXIT DEVICES

2200 SERIES EXIT DEVICES

CAL-ROYAL

- Rim Type Exit Device
- ANSI A156.3 Grade 1, UL & ULC Listed
- 1-year Mechanical Warranty

2200EO—

- Chassis mounted unit construction.
- Lever and escutcheon trims are grade 1 construction with clutch freewheeling mechanism. Rose and escutcheon covers 161 cut out.

SPECIFICATIONS—

- **FOR DOORS:** For 1-3/4" door thickness. 4-1/2" minimum stile width required for single or double door applications using standard 239 strike and pull or lever trims.
- **CHASSIS:** Nonferrous alloy.
- **COVER:** Nonferrous alloy. Covers stock hollow metal doors with 161 cutout.
- **MOUNTING:** Furnished with wood and machine screws.
- **END CAP:** Steel construction.
- **ALARM:** Available.
- **HAND:** Non handed, center hub.
- **LATCHBOLT:** Stainless steel 3/4" throw.
- **SPRING:** Stainless steel throughout.
- **ANSI STANDARD:** A156.3, Grade 1.
- **RAIL ASSEMBLY:** Heavy gauge steel, painted.
- **STRIKE:** 239 packed standard.
- **DOGGING FEATURE:** Allen-type key furnished.
- **MULLION:** Special order.
- **DOOR SIZE:** 2200EO36 for 36" doors. (2'9" to 3' doors)
- **CENTER CASE:** 5-1/8" x 2-3/4" x 2"

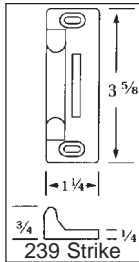

2260V 3684—Same as above unless listed below.

- **FOR DOORS:** For 1-3/4" door thickness. 3-3/4" minimum stile width required for single door applications. 3-1/2" minimum stile width for double door applications.
- **ALARM:** Available by special order.
- **HAND:** Easily field reversible. Specify LHRB or RHRB for convenience.
- **LATCHBOLT, SPRING:** Stainless steel.
- **DOOR SIZE:** 2260V 3684 for 36" x 84" doors. (2'9" to 3' doors)
- **STRIKES:** 221 & 227 packed standard.
- **TOP AND BOTTOM RODS:** Top rod 43-1/4", bottom rod 37-3/4".
- **VERTICAL RODS:** 1/2" round tubing.
- **TOP AND BOTTOM CASES:** 3-15/16" x 2-1/8" x 1-3/8".

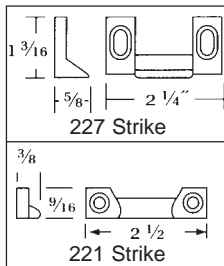

ALARM EXIT HARDWARE—

Alarm units has an internal horn. When the push rail is depressed, the horn sounds to provide an audible means of signaling that the door has been opened and violated.

The unit has changeable 2 minute alarm cutoff or manual reset. Preset at the factory for 2 minute alarm cutoff. Jumper cable is provided to switch to continuous alarm.

The key switch to turn the alarm off is a standard 1-1/4" cylinder with "C" keyway. The alarm operates on one standard 9 volt transistor battery. When battery is weak the horn will emit an intermittent signal.

Alarmed units are supplied with two switches. One switch monitors the push rail and the other switch monitors the latchbolt for full proof security. Unit includes "EMERGENCY EXIT ONLY ALARM WILL SOUND" decals for application on door or unit.

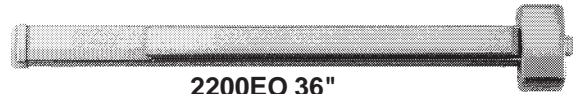

2200EO 36"

Also stock Vertical Bars (2260V 3684)



ALRM2200EO 36"



2-5/8" x 15"

- THP00 Entrance
- THP05 Storeroom
- THP30 Passage
- THP40 Dummy



ENT00L Entrance with clutch
3-1/2" rose diameter

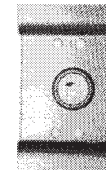

2200NL
3" x 7-3/4"

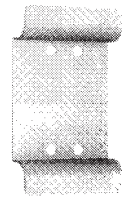

2200DTP
3" x 7-3/4"

Stock No.

- 2200EO 36"**
- 2260V 3684**
- ALRM2200EO 36"**
- 2200DTP**
- 2200NL**
- ENT00L**
- THP00**

Description

- Exit Only
- Vertical Bar-Exit Only
- Exit Only w/alarm
- Exterior Trim-see above
- Exterior Trim-see above
- Exterior Trim-see above
- Exterior Trim-see above

TO ORDER, SPECIFY:

FOR BAR-

Stock No. and Finish

FOR TRIM-

Stock No. and Finish

- Finishes:** ALUM Aluminum
DURO Duronodic
GOLD Gold

ENT00L—

- Finishes:** US-3 Bright Brass
US-10B Oil Rubbed Bronze
US-26D Satin Chrome

EXIT DEVICES

5000 SERIES EXIT DEVICES

- Rim Type Exit Device
- ANSI A156.3 Grade 2, UL Listed
- 1-year Mechanical Warranty

CAL-ROYAL

5000EO SPECIFICATIONS—

- **FOR DOORS:** 1-3/4" thick standard. 4-1/2" minimum stile width required for single or double door application using standard 239 strike and pull or lever trims.
- **CHASSIS:** Steel.
- **COVER:** Covers stock hollow metal doors with 161 cutout.
- **MOUNTING:** Furnished standard with metal & machine screws.
- **END CAP:** Steel construction.
- **HAND:** Non handed, center hub.
- **LATCH BOLTS:** Stainless steel 3/4" throw.
- **SPRING:** Steel throughout.
- **ANSI STANDARD:** A156.3, Grade 2.
- **RAIL ASSEMBLY:** Heavy gauge steel, painted.
- **STRIKE:** 239 strike standard. Shown at right.
- **DOGGING:** Allen-type key furnished standard on the non-fire-labeled devices.
- **U.L. LISTED:** 5000 Series for panic.
- **PROJECTION:** Neutral: 2-1/2", depressed 1-3/4".
- **BACKSET:** 2-3/4".
- **DOOR WIDTH:** For doors 2' 9" to 3' 0" wide.
- **MOUNTING HEIGHT:** 41" at center.
- **CYLINDER:** Schlage "C" keyway.
- **OPERATION:** Inside by slight pressure on any point on the push bar at all times.
- **DOOR SIZE:** For 36" door.

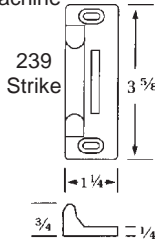

5000V SPECIFICATIONS—

- **FOR DOORS:** 1-3/4" thick standard. 3-3/4" minimum stile width required for single door applications. 3-1/2" for double doors.
- **HAND:** Easily field reversible. Specify LHRB or RHRB for convenience.
- **STRIKE:** 221 and 227 strikes standard, at right.
- **LATCH BOLT, SPRING:** Stainless steel.
- **PROJECTION:** Neutral: 2-1/2", depressed 1-3/4".
- **DOOR WIDTH:** For doors 2' 9" to 3' 0" wide.
- **MOUNTING HEIGHT:** 41" at center.
- **TOP & BOTTOM ROD LENGTH:** Top: 43-1/4", Bottom: 37-3/4".
- **VERTICAL ROD:** 1/2" round tubing.
- **DOOR SIZE:** For 36" x 84" doors.

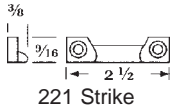
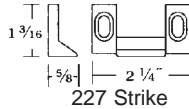

5000EO 36" ALUM
5000EO 36" 32D



5000V 3684 ALUM
5000V 3684 32D



Entrance "C" Keyway
8000L 26D (pictured)
CLU5000L 26D*

*Picture is similar for CLU5000L but has a clutch and Rose dia. is 3-1/2".

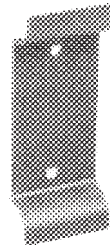

5000 DTP 26D
3" x 7-3/4"

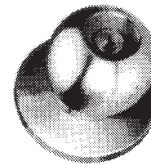

Entrance
8000K 32D
"C" Keyway
3" rose

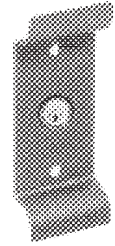

5000 NL 26D
"C" Keyway
3" x 7-3/4"

TO ORDER, SPECIFY:

FOR BAR-
Stock No. and Finish

FOR TRIM-
Stock No. and Finish

Finishes: ALUM Aluminum
US-32D Stainless Steel

Trims—
Finishes: US-26D Satin Chrome
US-32D Stainless Steel

EXIT DEVICES



- ANSI A156.3, Type 1, Grade 1
- A117.1 Accessibility Code
- 3-year limited warranty

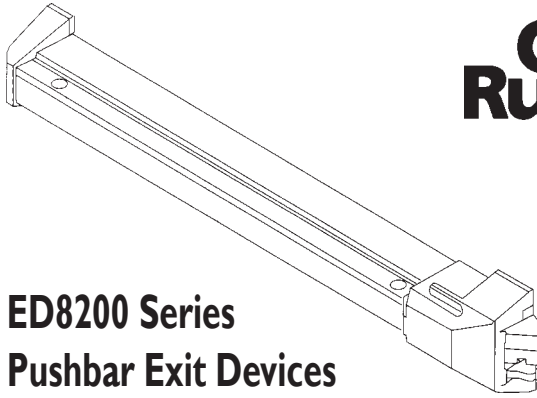

ED8200 Series Pushbar Exit Devices

- Heavy duty steel construction and Grade 1 performance, priced for outstanding value. Meets rigorous life safety and security requirements, while offering pleasing aesthetics and trouble-free operation. Designed for high-use, high-abuse situations, ED8000 Pushbar Exit Devices can be teamed with a variety of Corbin Russwin trims to provide desired functions, styles and finishes in new construction and renovations.
- **U.L.** listed for safety as panic hardware..
- **ANSI:** Meets A156.3, Type 1, Grade 1, and A117.1 Accessibility Code.
- **ADA:** Exit Devices, lever trims and pulls comply.
- **Handing:** Non-handed. ▪ **Fasteners:** Machine screws.
- **Bar Length:** Easily field cut to size. 36" bar fits 31" - 36" door; 42" bar fits 37" - 42" door.
- **Door Thickness:** 1-3/4". ▪ **Stile:** Minimum width 5".
- **Backset:** 2-3/4". Device and trim cover standard ANSI A115.2 (Type 161) cylindrical lock preparation.
- **Latchbolt:** 3/4" stainless steel pullman type with stainless steel deadlocking latch.
- **Projection:** 2-1/2" low profile for barrier-free access.
- **Material:** Heavy duty wrought steel chassis and pushpad: aluminum front and rear bar covers; stainless steel springs; nylon bearings.
- **Dogging:** Single point 1/4 turn dogging.
- **Cylinder:** Brass, 6-pin L4 keyway, 0-bitted.
- **Warranty:** Three-year limited.

Complete Devices

Stock No.	Type of trim
RE-ED8200	Exit Only
RE-ED8200B	Exit Only-Fire Rated-see below

For complete device with trims not listed above order RE-ED8200 bar and the outside trim you need shown below. (EX: RE-ED8200 and RE-P850)

Trims (for complete device order with RE-ED8200)

Stock No.	Type of trim
RE-F150	Flat Plate-Dummy
RE-F157	Flat Plate-Nightlatch w/rim cylinder
RE-G1055	Global Knob-Classroom function
RE-N655	Newport Lever-Classroom Function
RE-P850	Wing Pull-Dummy
RE-P857	Wing Pull-Nightlatch w/rim cylinder

Finishes

For F150, G1055, N655 products:

- 612 Satin Bronze
- 613 Dark Oxidized Satin Bronze oil rubbed
- 626 Satin Chrome Plated

For ED8200, F157, P850, P857 products:

- 689 Silver Aluminum Painted
- 690 Dark Bronze Painted

Dogging Key

Stock No.	Description
RE-123F538	Size: 3/16", dogging key

RE-ED8200B 1-1/2 Hour Fire Rated Rim Exit Device
Complies with NFPA 80 Fire Doors. Warnock Hersey International(WHI)-rated for B label and lesser class 4' x 8' single or 8' x 8' double doors. Furnished with sex nuts and bolts. Dogging not available.

TO ORDER, SPECIFY

Stock No., Finish and Width (EX: RE-ED8200 689 36") AND OUTSIDE TRIM, IF NEEDED (EX: RE-N655 626)

RIM STRIKE SUPPLIED (386F45)



Standard strike supplied with ED8200

—OUTSIDE TRIM—

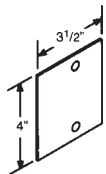

RE-F150 (Shown)
RE-F157 w/ rim cylinder

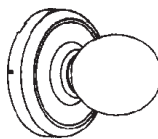

RE-G1055 w/key-in-knob cylinder



RE-N655 w/key-in-lever cylinder

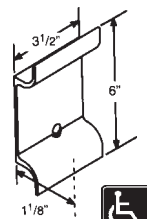

RE-P850 (Shown)
RE-P857 w/ rim cylinder

©ZIPF LOCK COMPANY

EXIT DEVICES



- ANSI A156.3, Type 2, Grade 1
- A117.1 Accessibility Code
- 3-year warranty

ED8400 Series

Vertical Rod Pushbar Exit Devices

▪ Heavy duty steel construction and Grade 1 performance, priced for outstanding value. Meets rigorous life safety and security requirements, while offering pleasing aesthetics and trouble-free operation. Designed for high-use, high-abuse situations, ED8000 Pushbar Exit Devices can be teamed with a variety of Corbin Russwin trims to provide desired functions, styles and finishes in new construction and renovations.

- **U.L.** listed for safety as panic hardware..
- **ANSI:** Meets A156.3, Type 2, Grade 1, and A117.1 Accessibility Code.
- **ADA:** Exit Devices, lever trims and pulls comply.
- **Handing:** Handed-SPECIFY hand LHR or RHR.
- **Fasteners:** Machine screws.
- **Bar Length:** Easily field cut to size. 36" bar fits 31" - 36" door;
- **Door Thickness:** 1-3/4".
- **Stile:** Minimum width 5".
- **Backset:** 2-3/4". Device and trim cover standard ANSI A115.2 (Type 161) cylindrical lock preparation.
- **Door Height:** All top rods easily field cut to size. Top rod for 7'6" door.
- **Projection:** 2-1/2" low profile for barrier-free access.
- **Latchbolts:** Top: 1/2" interlocking drop latch;
Bottom: 5/8" pivoted.
- **Vertical Rods:** Inverted U-shaped rectangular.
- **Material:** Heavy duty wrought steel chassis and pushpad: steel vertical rods; aluminum bar and latch covers; stainless steel springs; nylon bearings.
- **Dogging:** Single point 1/4 turn dogging.
- **Cylinder:** Brass, 6-pin L4 keyway, 0-bitted.
- **Warranty:** Three-year limited.

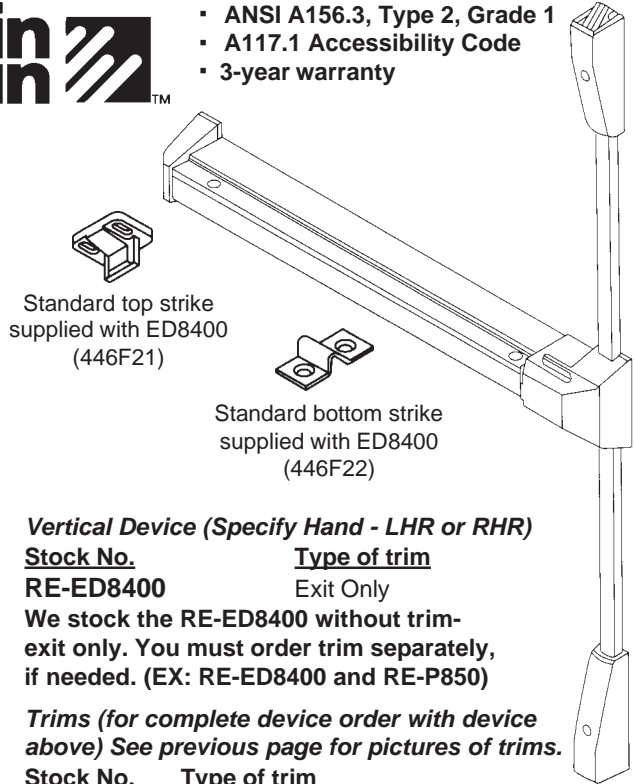

Standard top strike supplied with ED8400 (446F21)

Standard bottom strike supplied with ED8400 (446F22)

Vertical Device (Specify Hand - LHR or RHR)

Stock No.	Type of trim
RE-ED8400	Exit Only

We stock the RE-ED8400 without trim-exit only. You must order trim separately, if needed. (EX: RE-ED8400 and RE-P850)

Trims (for complete device order with device above) See previous page for pictures of trims.

Stock No.	Type of trim
RE-F150	Flat Plate-Dummy
RE-F157	Flat Plate-Nightlatch w/rim cylinder
RE-G1055	Global Knob-Classroom function
RE-N655	Newport Lever-Classroom Function
RE-P850	Wing Pull-Dummy
RE-P857	Wing Pull-Nightlatch w/rim cylinder

Strike for Inactive Door

Stock No.	Description
RE-468F30	Use on inactive door of pair of doors

Finishes

For F150, G1055, N655 products:

- 612 Satin Bronze
- 613 Dark Oxidized Satin Bronze oil rubbed
- 626 Satin Chrome Plated

For ED8400, F157, P850, P857, 468F30 products:

- 689 Silver Aluminum Painted
- 690 Dark Bronze Painted

Dogging Key

Stock No.	Description
RE-123F538	Size: 3/16", dogging key

Need a Corbin Russwin Exit Device not shown here??

Give us a call with your needs

1-800-848-1577

OPTIONAL STRIKE

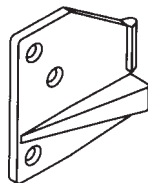

RE-468F30 Required for ED8200 devices when used on a pair of doors with ED8400 device.

HANDING

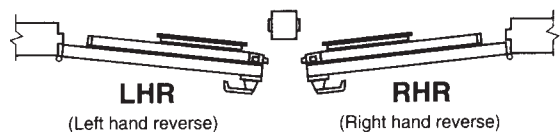

Outside

EXIT DEVICES

EXIT CONTROL LOCK

DETEx

Meets ADA
Requirements



BENEFITS—

- Deters unauthorized exit.
- Reduces employee and customer theft.
- Proven durability, reliability and long service life at a reasonable price.
- Best in class attack resistance from the outside: withstands over 2200 lbs. static load (outside pull force).
- Time tested construction resists attack from the inside.
- UL Listed panic hardware exceeds life safety, ADA, CA Title 19, ANSI/BHMA requirements for all building codes.
- 5-year limited warranty.

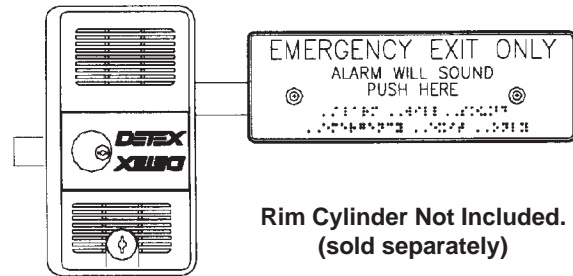

Rim Cylinder Not Included.
(sold separately)

FEATURES—When armed, pressing the exit bar retracts the deadbolt and sounds the alarm to allow exit. An authorized key simultaneously projects the bolt, secures the door and resets the alarm.

Use of the control key permits unlocking the door without sounding the alarm.

Approximately 100db alarm commands attention even in the noisiest environment. Powered by one standard 9 volt battery. 1" throw, saw resistant deadbolt. Rugged housing with key lock. Corrosion resistant alloy lock body. Non handed.

Stock No. **Description**
DET-ECL230D Exit Control Unit

SPECIFICATIONS

- SIZE:** 10-3/8" H x 5-3/4" W x 3-3/4" D (lock case)
3-1/8" H x 12-7/8" W (push plate and bar)
- PADDLE:** 3" H x 8-7/8" L. Florescent orange.
- BACKSET:** For door preparation of 2-3/4"
- STRIKES:** 1ea ECL437K Adjustable Surface (standard)
1ea ECL439K Mortise Strike Plate Kit
- FINISH:** Die-cast aluminum alloy housing with Corvel Detex Silverado finish. Florescent orange paddle.

EXIT CONTROL LOCK - FIRE RATED

BENEFITS—(same as above, plus...)

- Automatic relatching for added security and fire rating.
- Warnock Hersey Labeled fire exit hardware exceeds life safety, ADA, CA Title 19, ANSI/BHMA requirements for a building codes.
- May be used on 36" - 48" wide doors.
- 5-year limited warranty.

Rim Cylinder Not Included.
(sold separately)

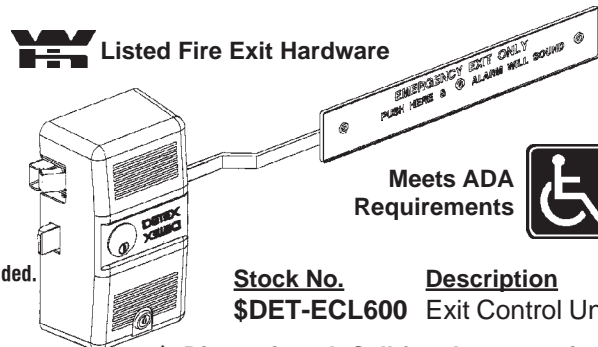

Meets ADA
Requirements



Stock No. **Description**
\$DET-ECL600 Exit Control Unit

\$=Discontinued. Call for closeout prices.

FEATURES—The deadbolt and deadlocking latch bolt retract simultaneously and sounds the alarm when the paddle bar is pushed to exit.

To reset the alarm, an authorized key projects the bolt, secures the door and resets the alarm. Use of the control key permits unlocking the door without sounding the alarm.

Approximately 100db alarm commands attention even in the noisiest environment. Powered by one standard 9 volt battery. 1" throw, saw resistant deadbolt. Rugged housing with key lock. Corrosion resistant alloy lock body. Non handed.

- SIZE:** 10-3/8" H x 5-3/4" W x 3-3/4" D (lock case)
2-1/2" H x 24-1/8" W (push plate and bar)
- PADDLE:** 2-1/2" H x 16" L. Florescent orange.
- BACKSET:** For door preparation of 2-3/4"
- STRIKES:** Keeper & strike kit included.
- FINISH:** Die-cast aluminum alloy housing with Corvel Detex Silverado finish. Florescent orange paddle.

MISCELLANEOUS

DET-ECL475K
Decorative Back
Plate Kit.

DET-PP5572-15
Replacement Cover Lock.

DET-ECL435K
Adjustable surface keeper. "L" & "Z"
bracket for double door applications.

DET-ECL2111K
9 volt adapter kit for the 230C & D
exit alarms with a 6 volt battery.
Use this kit to convert from 6V to
9V. Includes 9V battery, replace-
ment horn, wiring & instructions.

©ZIPF LOCK COMPANY

EXIT DEVICES

VALUE SERIES EXIT



Meets ADA
Requirements



BENEFITS—

- Best value for durable attractive loss prevention door hardware.
- Reduces employee and customer theft.
- Controls foot traffic, deters unauthorized exits and meets building code requirements for panic and fire exit hardware.
- Patented installation eliminates the need for a paper template, providing precise alignment with the door and frame.
- Fast, easy, secure installation prevents costly mistakes and enhances overall security.
- Tamper resistant housing protects electronics, battery and internal hardware, preventing manipulation.
- Relatching bolt automatically relocks the device when the door closes.
- Low profile keeps the opening clear while the door is open.
- Cylinder dogging is standard.
- Grade 1, UL Listed fire and panic exit hardware exceeds life safety, ADA, CA Title 19, ANSI/BHMA requirements for all building codes.
- 3-year limited warranty with 1-year electronics warranty.

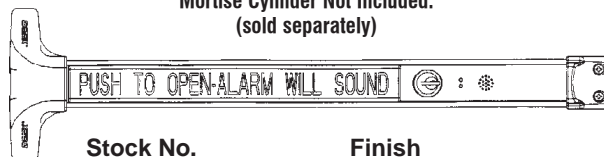

Mortise Cylinder Not Included.
(sold separately)

Stock No.	Finish
DET-V40 EB AL 36"	Aluminum (628)
DET-V40 EB BK 36"	Black (711)

AL Aluminum (628) baseplate, red push pad with white warning letters, and black (711) cover, filler plate and end cap.
BK Black (711) baseplate, red push pad with white warning letters, and black (711) cover, filler plate and end cap.

FEATURES:

- Stainless steel self-latching bolt
- Tamper-resistant housing
- Delayed arming feature
- Field selectable manual rearming or auto-rearming
- Powered by standard 9-volt battery
- Low battery alert

OPERATION: Alarm is armed or disarmed by key. A mortise cylinder with standard cam is required (sold separately). The 100db alarm will sound with any unauthorized exit.

EAX-500 SERIES EXIT

BENEFITS—

- Low-cost, self-contained door alarm with piezo horn that sounds to warn unauthorized use of a door.
- Patented plastic template allows for foolproof alignment of internal magnetic door contact and an accurate installation.
- Tapered cover allows for installation on narrow stile doors, 2" minimum.
- An intelligent circuit that automatically senses the "hanging" of the alarm location on the door.
- Patented cam assembly automatically adjust for different sizes of cylinders without the use of spacers.
- Extended bypass now a standard feature - user may deactivate if necessary.
- Low battery alert. LED visual/audible arming indicators.
- Field selectable: 2-minute auto rearm, status indicators.
- Easy to install using common tools.

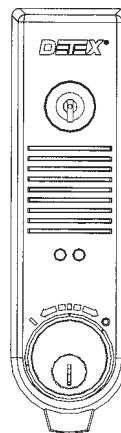

Mortise Cylinder
not included - order
separately

Stock No.	Description
DET-EAX-500	Surface Door Mount

PHYSICAL SPECIFICATIONS:

Dimensions:
2.10"W x 2.375"D x 7.70"L

Housing:
Grey finish polymer case

Battery:
9V Energizer battery included

Warning Sign:
1 ea red and white pressure sensitive sign reading "EMERGENCY EXIT ONLY ALARM WILL SOUND". (11" x 3-3/8")

Cylinder: (not included)
Alarm accepts 5, 6, and 7 pin standard and interchangeable core mortise cylinders with a standard Yale cam for inside control. Rim cylinder required for outside control.

OPERATION: To arm - Insert and rotate the key counterclockwise until the green LED illuminates, remove key. The green LED light will illuminate for 15 seconds during the arming sequence followed by 3 chirps indicating the alarm is armed. To disarm - Insert and rotate the key clockwise until the red LED flashes twice, remove key. The red LED will flash twice periodically indicating the unit is disarmed.

©ZIPF LOCK COMPANY

EXIT DEVICES

NON-HANDED RIM DEVICE MO-19-R SERIES

UL Listed
ANSI A156.3, 1994, Grade 1



The Monarch 19-R Series Rim Device meets the demand for superior panic hardware. This durable economical device is designed to meet the needs for modern touchbar styling by eliminating the need for lever arms and crossbars. This non-handed device covers a 161 cutout and may be used on 1-3/4" narrow stile aluminum doors. The "EO" (exit only) device is ready to accept any trim function pictured on page 355.

EXIT ONLY—(Pictured above)

Stock No.	Door Width
MO-19-R-EO 3'	For 2' 5" to 3' 0" wide doors (Short)
MO-19-R-EO 4'	For 2' 11" to 4' 0" wide doors (Long)

EXIT ONLY (with alarm)—

Stock No.	Door Width
MO-EA19-R-EO 3'	For 2' 5" to 3' 0" wide doors (Short)

EXIT ONLY FIRE RATED—(SP28 ONLY)

Stock No.	Door Width
MO-F19-R-EO 3'	For 2' 5-1/4" to 3' 0" wide doors (Short)

FINISHES: SP28(MAL) Lacquer Sprayed Aluminum
SP313(M13) Sprayed Duranodic

TO ORDER, SPECIFY: Device Stock No. and Finish.
Trim Stock No. and Finish (if trim is needed)

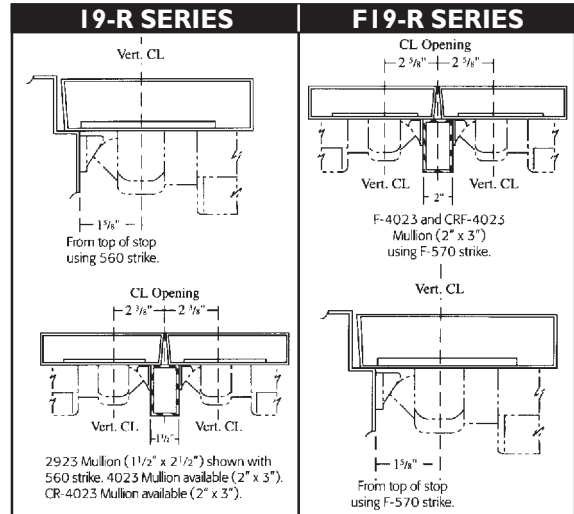

See page 355 for trims and accessories.

SPECIFICATIONS:

Hand: Non-Handed.

Functions: All functions built into "EO" device. All 19 Series trim works with rim or vertical devices.

Finishes: SP28-Lacquer Sprayed Aluminum; SP313-Sprayed Duranodic.

Strikes: 560 standard.

Latchbolt: Stainless steel, 3/4" throw.

Deadlocking Latchbolt: Standard.

Dogging Feature: 1/2 turn cam dogging standard. No threaded parts to wear out.

Stock Sizes: Short—2' 5" to 3' 0" wide doors; Long—2' 11" to 4' 0" wide doors

Doors: 1-3/4" thick, wood or metal. Other sizes are special order only.

Overall Length: Short: 30-1/2", Long: 44-1/8". (19-R add 3/4" for latchbolt projected)

Narrow Stile Door: Must order optional strike **MO-565** x finish. Also see NOTE.

Projection: 2-1/2" maximum; 1-7/8" dogged.

Fasteners: All mounting screws are concealed. Furnished with machine screws.

Sex Bolts: 3-#4122 (1/4-20) SNB standard. 

ANSI: Certified ANSI A156.3-1994 Grade 1 standards.

161 Cutout: Device covers 161 cutout with KIK/KIL, Centron and Trident trims. Other trim requires cover plate.

FIRE RATED SPECIFICATIONS: (Same as above unless listed below)

Strikes: Stainless steel, F570 standard.

Stock Sizes: Short—2' 5-1/4" to 3' 0" wide doors.

Dogging: Not available.

Projection: 2-1/2" maximum.

Fasteners: All mounting screws are concealed. Furnished with machine screws and SNB. 



NOTE: When using on narrow stile glass doors order the 4" (long) bar and cut down to size required.

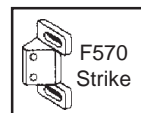

EXIT DEVICES

REVERSIBLE VERTICAL ROD DEVICE MO-19-V SERIES

UL Listed
ANSI A156.3, Grade1

MONARCH
Exit Devices & Door Hardware



Manufactured with the same outstanding quality as the 19 Rim, the 19-V Exit Device complies with most exit door requirements. The 19-V is fully reversible and surface applied. The device is regularly furnished with pullman latch top which contains the deadlocking and latch retention feature. The "EO" (exit only) device is ready to accept any trim function shown on page 355.



EXIT ONLY—

Stock No. **Door Width**
MO-19-VEO 3' For 2' 5-1/4" to 3' 0" wide doors (Short)

EXIT ONLY FIRE RATED—(Special Order)

Stock No. **Door Width**
MO-F19-VEO 3' For 2' 5-1/4" to 3' 0" wide doors (Short)

FINISHES: **SP28(MAL)** Lacquer Sprayed Aluminum
SP313(M13) Sprayed Duranodic

See page 355 for trims and accessories.

TO ORDER, SPECIFY:
Device Stock No., Finish and Hand(LHR or RHR)
Trim Stock No. and Finish (if trim is needed)

SPECIFICATIONS:

- Hand:** Field reversible.
- Functions:** All functions built into "EO" device. All 19 Series trim works with rim or vertical devices.
- Finishes:** **SP28**-Lacquer Sprayed Aluminum; **SP313**-Sprayed Duranodic.
- Strikes:** Surface applied 4163 strike is standard. 2130 strike is mortised into floor.
- Latchbolt:** Top Stainless steel, 3/4" throw.
- Deadlocking Latchbolt:** Standard.
- Dogging Feature:** 1/2 turn cam dogging standard. No threaded parts to wear out.
- Stock Sizes:** Short—2' 5-1/4" to 3' 0" wide doors.
- Doors:** 1-3/4" thick, wood or metal. Other sizes are special order only.
- Overall Length:** Short: 30-1/2", Long: 44-1/8".
- Narrow Stile Door:** To 1-3/4" N.S. aluminum. With control trim-1/4" min stile. 4' (long) device is recommended (special order only).
- Projection:** 2-1/2" maximum: 1-7/8" dogged.
- Fasteners:** All mounting screws are concealed. Furnished with sheet metal screws for mounting rods. #2729 sex bolts (special order) required if mounting on hollow core wood, light gauge hollow metal, etc.
- Sex Bolts:** 3-#4122 (1/4-20) SNB standard for mounting bar. 
- ANSI:** Certified ANSI A156.3, Grade 1 standards.
- 19-v1 x 2130:** Pullman latch top and bottom. 4163 strike top, 2130 flush strike bottom.
- 161 Cutout:** device covers 161 cutout with KIK/KIL, centron and trident trims. Other trim requires cover plate.



FIRE RATED SPECIFICATIONS: (Same as above unless listed below)

- Strikes:** 3788 surface applied strike standard. 2130 strike is mortised into floor.
- Stock Sizes:** Short—2' 5-1/4" to 3' 0" wide doors.
- Dogging:** Not available. **Projection:** 2-1/2" maximum. 
- Fasteners:** All mounting screws are concealed. Furnished with machine screws and SNB.

Need a Monarch Product not shown?? Just give us a call — 1-800-848-1577

EXIT DEVICES

TRIMS—For 19 Series

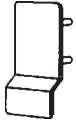

Trident Pull
MO-920DT*
(Old# 1953DT)
SP28, SP313

*Specify Hand:
LHR or RHR

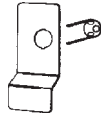

Trident Pull
MO-920NL*
(Old# 1955P)
SP28, SP313



Centron Trim
MO-930C
(Old# 2302)
SP28, SP313



Centron Trim
MO-930NL
(Old# 2305)
SP28, SP313



T-Control
MO-910TP
(Old# 1906RVL)
SP28, SP313



P-Control
MO-910NL
(Old# 1909)
SP28, SP313

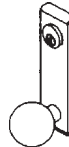

K-Control
MO-911K
(Old# 1907RVL)
SP28, SP313

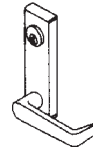

L-Control
MO-912L LHR or RHR
(Old# 1910RVL, 1910RR)
SP28, SP313

Specify
Hand

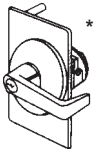

Key-in-lever
MO-914KIL-KD*
(Old# 2400KD)
US-32D, SP313

*Field Reversible Handing
Cylinders included on
MO-914 and MO-913
Schlage C keyway

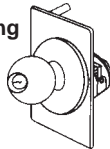

Key-in-knob
MO-913KIL-KD*
(Old# 2410KD)
US-32D

FUNCTION:

Keyed trims lock or unlock trim. Lever/knob/thumbturn retracts latchbolt when trim is unlocked.

CYLINDERS NOT INCLUDED

FINISHES:

SP28 (MAL) Lacquer Sprayed Aluminum
SP313 (M13) Sprayed Duranodic
US-32D Satin Stainless Steel

STRIKES—Specify Finish

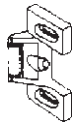

Roller Strike
MO-490
Unfinished

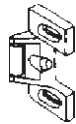

Fire Rated Roller Strike
MO-F490



Rim Strike
MO-565
SP28, SP313



Rim Strike
MO-570
32D



Fire Rated Rim Strike
MO-F570
32D



Rim Strike on
Double Doors
MO-571
SP28, SP313

COVER PLATES—Specify Finish



MO-4167 SP28, SP313
For 19 Series T and DT control



MO-4170 SP28, SP313
For 19 Series K, L, DT-K, DT-L
control

HEX KEY—

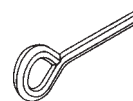

MO-2789 7/32" Hex key for 19 Series.

EXIT DEVICES

VON DUPRIN

22 SERIES TOUCH BAR EXIT DEVICE

UL Listed
ANSI A156.3, 1994, Type 1, Grade 1

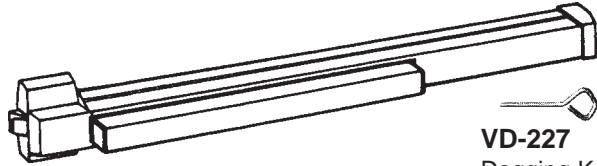

VD-227
Dogging Key
Size: 5/32"

Stock No.	Description
VD-22EO 3'	EXIT ONLY (2'6" to 3' wide doors)
VD-22EO 4'	EXIT ONLY (3'1" to 4' wide doors)

FINISHES: **SP28** Sprayed Aluminum
SP313 Sprayed Dark Bronze (duranodic color)

TRIMS — (Optional)

Rim Cylinder
Not Included

Mortise Cylinder
Not Included

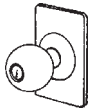

VD-210K
Key unlocks knob.
3" x 4-25/32"



VD-230NL
Key retracts
latch bolt
3" x 12-1/16"



VD-230TP
Key unlocks
thumbpiece.
3" x 12-1/16"

VD-210NL
Pull with cylinder
Key retracts
latchbolt
5-3/4" x 4-25/32"



VD-230L
Key unlocks
lever
3" x 6-3/8"



DESCRIPTION —

22 rim device for all types of single and double doors with mullion, UL Listed for accident hazard installations. Covers most stock hollow metal doors with 161 cutouts. Fits 1-3/4" or 2-1/4" doors.

FEATURES: •Non-handed •Field sizeable •3/4" throw latch bolt •Latch bolt deadlocking •Hex key dogging.

DIMENSIONS: •Touch bar height to finished floor—39-13/16" at center •Touch bar projection, neutral—3-3/4", depressed—3" •Center case—4-3/16" x 2-3/8" x 2-3/4" •Minimum door stile: 3-13/16".

STRIKE: Device is furnished standard with 299 strike in dull black finish.

FINISHES: **SP28** Sprayed Aluminum
SP313 Sprayed Dark Bronze (duranodic color)

22 SERIES EXIT ALARM KIT

\$-Discontinued, Call for closeout price.



Stock No.	Description
\$VD-22ALK	EXIT ALARM KIT
FINISHES: SP28	Sprayed Aluminum
SP313	Sprayed Dark Bronze (duranodic color)

DESCRIPTION —

The VD-22ALK battery alarm kit is a simple yet effective way to monitor the use of an exit device. While still a means of egress, the unit contains an internal horn. When the touch bar is depressed, the horn sounds to provide an audible means of signaling that the opening has been violated.

The key switch uses a standard 1-1/4" mortise cylinder. The unit operates on one standard 9-volt transistor battery. When the battery is weak the horn will emit an intermittent signal.

The alarm kit comes standard with the S1 switch that monitors the touchpad.

The VD-22ALK kit also includes "EMERGENCY EXIT ONLY, ALARM WILL SOUND" decal for application on door.

Due to the special VD-22ALK dogging cover, the dogging feature and other electrical options are NOT available.

The VD-22ALK can be easily installed on existing VD-22 bars. The VD-22ALK simply replaces the existing dogging cover on the VD-22 bar.

22 SERIES SURFACE MOUNTED VERTICAL ROD

UL Listed
ANSI A156.3, 1994, Type 2, Grade 1

\$-Discontinued, Call for closeout price.

Stock No.	Description
VD-2227EO 3'	EXIT ONLY (2'6" to 3' wide doors)
\$VD-2227EO 4'	EXIT ONLY (3'1" to 4' wide doors)
Uses same trims as 22 Series touch bar at left.	

DESCRIPTION —

2227 surface mounted vertical rod device for all types of single or double doors, UL Listed for accident hazard installations. Covers stock hollow metal doors with 161 cutouts and fits door stiles as narrow as 3-5/8". Fits 1-3/4" or 2-1/4" doors.

FEATURES: •Non-handed •Field sizeable •5/8" throw latch bolt •Latch bolt deadlocking •Hex key dogging.

DIMENSIONS: •Touch bar height to finished floor—39-13/16" at center •Touch bar projection, neutral—3-3/4", depressed—3" •Center case—4-3/16" x 2-3/8" x 2-3/4" •Top & bottom latch case—4-1/2" x 2-1/8" x 1-1/2" •Vertical Rods—1/2" square tubing. Max. door undercut: 1/4" •Minimum stile: 3-5/8".

STRIKE: Device is furnished standard with 248L-4, 304L and 299 strikes in dull black finish.

©ZIPF LOCK COMPANY

EXIT DEVICES

VON DUPRIN

33A SERIES TOUCH BAR EXIT DEVICE

For Narrow Stile Doors (Aluminum, etc)

UL Listed
ANSI A156.3, 2001, Grade1

\$-Discontinued, Call for closeout price.

Now with deadlocking latchbolt

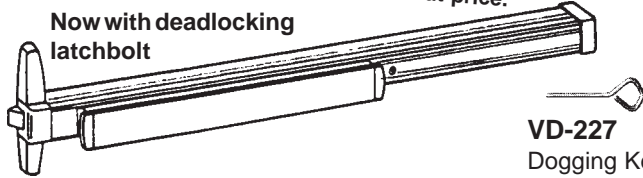

VD-227
Dogging Key
Size: 5/32"

Stock No.	Description
\$VD-33AEO 3' US28	EXIT ONLY (2'4" to 3' wide doors)

FINISHES: US-28 Anodized Aluminum

DESCRIPTION —

33A rim device for all types of single and double doors with mullions, UL Listed for Panic Exit Hardware. Device is non-handed, and fits doors with stiles as narrow as 1-3/4"

FEATURES: •Non-handed •Field sizeable •Deadlocking 3/4" throw latch bolt •Hex key dogging.

DIMENSIONS: •Touch bar height to finished floor—39-13/16" at center •Touch bar projection, neutral—3-13/16", depressed—3-1/16" •Center case—8-3/16" x 2-13/32" x 1-9/16" •Minimum door stile: 1-3/4".

STRIKE: Device is furnished standard with 1439 strike in dull black finish.

\$-Discontinued, Call for closeout price.

TRIMS — (Optional)

Rim Cylinder
Not Included

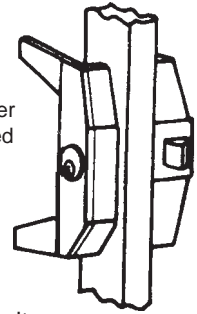

Stock No.
\$VD-336NL 26D

NL-Night latch. Key retracts latchbolt.

FINISHES: US-26D Dull Chrome

2670 EXIT ALARM LOCK

Secure, alarmed code-compliant protection for secondary exits

UL Listed
ANSI A156.3, Grade1
Panic Hardware (UL305)

Comples with NFPA 101®



Rim cylinder not included. Order separately.

Stock No.	Description
VD-2670 US28	EXIT ONLY (36" to 48" door width range)

FINISHES: US-28 Anodized Aluminum

DESCRIPTION —

The 2670 Series exit alarm lock provides secure protection through a large stainless steel deadbolt, which is 2" x 1/2" and has over a 3/4" throw. The engagement area into the strike is over 1-1/4" square inches. The cast aluminum latch case protects the internal mechanism and resists tampering or vandalism from inside the door. This unit has been tested to withstand up to 1600 pounds of static load force against the door. The GUARD-X does not allow relatching or resetting the alarm after an unauthorized exit, other than by an authorized person with a key. A 100-decibel alarm provides a clear, attention-getting warning for an unauthorized exit or attempted exit. The armed indicator light informs the owner that the alarm is armed, and an audible low-battery alert signals the owner to replace the 9 volt battery when necessary.

OPERATION: GUARD-X is armed and disarmed by key, using a standard rim cylinder. It can be operated from the building exterior by a standard rim cylinder, so an authorized user can easily arm and disarm it to enter or exit the building when required. When using exterior operation a pull trim is recommended, see trims above. Rim cylinders must be ordered separately.

DIMENSIONS: •Touch bar height to finished floor—40" at center •Touch bar projection, neutral—4-1/8", depressed—2-3/4" •Latch case housing—7" x 4-1/16" x 4-1/8" •Device length: 32-1/2"

STRIKE: Device is furnished standard with 267 roller strike.

GUARD-X

TRIMS — (Optional)

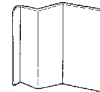

VD-210DT
Dummy pull
5-3/4" x 4-25/32"
1-31/32" projection

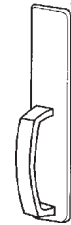

VD-230DT
Dummy pull
3" x 12-1/16"
2" projection

EXIT DEVICES

VON DUPRIN

88 SERIES CROSS BAR EXIT DEVICE

UL Listed
ANSI A156.3, 1994, Grade1

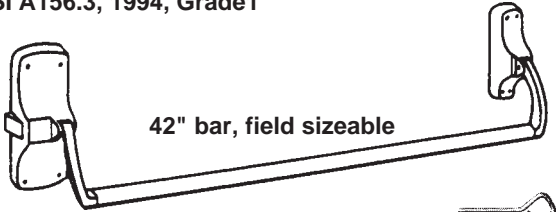

42" bar, field sizeable



VD-227
Dogging Key
Size: 5/32"

Stock No	Description
VD-88EO	EXIT ONLY (Nothing outside)
VD-88NL-R	NIGHT LATCH
\$VD-88TP	THUMB PIECE

FINISHES: US-4 Dull Brass
US-26D Dull Chrome

**\$-Discontinued, Call for
closeout price.**

88 SERIES SURFACE MOUNTED VERTICAL ROD

UL Listed
ANSI A156.3, 1994, Grade1

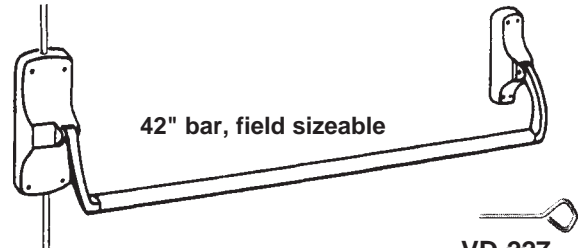

42" bar, field sizeable



VD-227
Dogging Key
Size: 5/32"

Stock No.	Description
VD-8827EO	EXIT ONLY (Nothing outside)
VD-8827TP 26D	THUMB PIECE

FINISHES: US-4 Dull Brass
US-26D Dull Chrome

TRIMS —



NL-R
Key retracts
latch bolt

Rim Cylinder
Not Included
order separately



TP
Key locks
thumb piece

TRIMS —

Rim Cylinder
Not Included
order separately



TP
Key locks
thumb piece

DESCRIPTION —

88 cross bar device for all types of single and double doors with mullion, UL Listed for accident hazard installations. Covers stock hollow metal doors with 86 or 161* (*not applicable with all strike and mullion combinations, consult factory) cutouts. Fits 1-3/4" thick doors

FEATURES: •Fully reversible •Field sizeable •3/4" throw latch bolt •Hex key dogging.

DIMENSIONS: •Cross bar height to finished floor—36-13/16" at center •Cross bar projection, neutral—4-3/4", depressed—4" •Cross bar length—42" field sizeable •Lock stile case—8-1/4" x 2-3/4" x 15/16" •Hinge stile case—6" x 1-3/4" x 15/16" •Crossbar tubing—1".

STRIKE: Device is furnished standard with 299 strike in dull black finish.

FINISHES: US-4 Dull Brass
US-26D Dull Chrome

DESCRIPTION —

8827 surface mounted vertical rod device is for all types of single and double doors, UL Listed for accident hazard installations. Covers stock hollow metal doors with 86 or 161 cutouts and fits door with stiles as narrow as 3-1/2". Fits 1-3/4" thick doors

FEATURES: •Fully reversible •Field sizeable •5/8" throw latch bolt •Hex key dogging.

DIMENSIONS: •Cross bar height to finished floor—36-13/16" •Cross bar projection, neutral—4-7/8", depressed—4" •Cross bar length—42" field sizeable •Lock stile case—8-1/4" x 2" x 15/16" •Hinge stile case—6" x 1-3/4" x 15/16" •Cross bar tubing—1" •Top and bottom latch cases—4" x 2" x 1-7/8" •Vertical rod—1/2" tubing •Up to 7" high doors.

STRIKE: Device is furnished standard with 299 (in dull black), 248L-4 and 304L.

FINISHES: US-4 Dull Brass
US-26D Dull Chrome

©ZIPF LOCK COMPANY

EXIT DEVICES

VON DUPRIN

99 SERIES TOUCH BAR EXIT DEVICE

UL Listed
ANSI A156.3, 2001, Type 1, Grade 1



VD-227
Dogging Key
Size: 5/32"

Stock No. Description

VD-99EO 3' EXIT ONLY (2'4" to 3' wide doors) US-3, 4, 26D, 28.

VD-99EO 4' EXIT ONLY (2'10" to 4' wide doors) US-26D, 28.

FINISHES: **\$US-3** Polished Brass **\$-Discontinued, Call for closeout price.**
\$US-4 Satin Brass
US-26D Satin Chrome
US-28 Anodized Aluminum

99 SERIES SURFACE MOUNTED VERTICAL ROD

UL Listed
ANSI A156.3, 2001, Grade 1

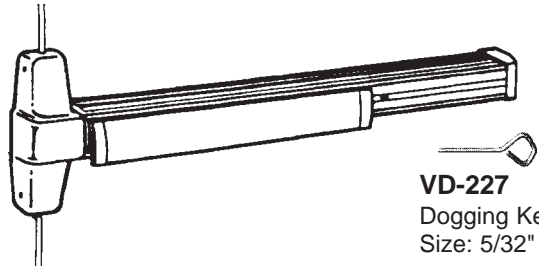

VD-227
Dogging Key
Size: 5/32"

Stock No Description

VD-9927EO 3' EXIT ONLY (2'4" to 3' wide doors)

FINISHES: **US-3** Polished Brass
US-26D Satin Chrome
US-28 Anodized Aluminum

TRIMS FOR 99 AND 9927 — (Optional)



VD-990DT R/V/M
Pull when dogged.
3"x14-3/16"x3/32"

Rim Cylinder
Not Included



VD-990NL R/V
Key retracts
Latch bolt.
3"x14-3/16"x3/32"

Rim Cylinder
Not Included



VD-990TP R/V
Key locks/unlocks
thumbpiece.
2-3/4"x10-3/4"x27/32"

Rim Cylinder
Not Included

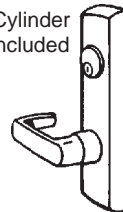

VD-992L R/V
Key locks lever
2-3/4"x10-3/4"x27/32"

Specify Hand:
LHR or RHR

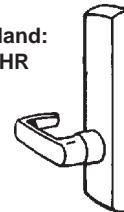

VD-992L BE R/V
Blank escutcheon, lever
always operable.
2-3/4"x10-3/4"x27/32"

Specify Hand:
LHR or RHR

DESCRIPTION —

99 rim device for all types of single and double doors with mullion, UL Listed for Panic Exit Hardware. Covers stock hollow metal doors with 86 or 161 cutouts on single doors. Fits 1-3/4" and 2-1/4" thick doors

FEATURES: •Non-handed •Field sizeable •Deadlockin 3/4" throw latch bolt •Hex key dogging.

DIMENSIONS: •Touch bar height to finished floor—39-13/16" at center •Touch bar projection, neutral—3-13/16", depressed—3-1/16" •Center case—8" x 2-3/4" x 2-3/8".

STRIKE: Device is furnished standard with 299 strike in dull black finish.

DESCRIPTION —

9927 surface mounted vertical rod device for all types of single and double doors, UL Listed for Panic Exit Hardware. Covers stock hollow metal doors with 86 or 161 cutouts. Fits 1-3/4" & 2-1/4" thick doors

FEATURES: •Non-handed •Field sizeable •Deadlocking anti-friction top & bottom bolt, 5/8" throw •Hex key dogging.

DIMENSIONS: •Touch bar height to finished floor—39-5/8" at center •Touch bar projection, neutral—3-13/16", depressed—3-1/16" •Center case—8" x 2-3/4" x 2-3/8". Top and bottom latch case—4-1/2" x 2-1/8" x 1-1/2" •Vertical rods—1/2" square tubing •Up to 7' doors. Max undercut: 1/4".

STRIKE: Device is furnished standard with 299, 248L and 304L strikes.

Need a Von Duprin product not shown here?? Just give us a call — 1-800-848-1577

EXIT DEVICES

VON DUPRIN

SPECIFICATIONS FOR STRIKES FURNISHED IN EXIT DEVICES

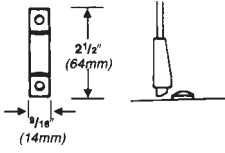

248L-4

Projection: 3/8"

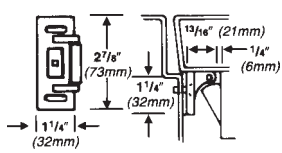

299

Projection: 13/16"

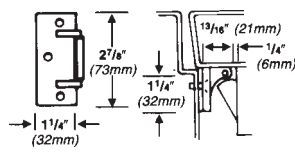

299F

Projection: 13/16"

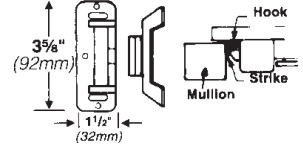

499F

Projection: 15/16"

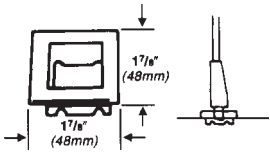

304L

Mortise: 13/16"

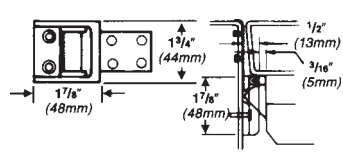

1439 Blade Stop

Projection: 1/2"

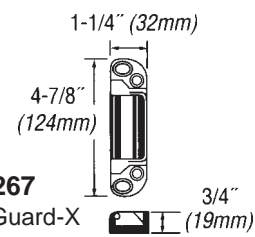

267

For Guard-X

EXIT DEVICE HANDING CHART

