

ALUMINUM DOOR LOCKS

HALT Narrow Stile Locks

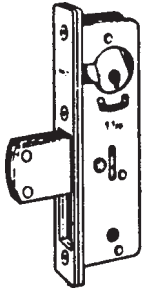

DEADBOLT (LOCK ONLY)

STOCK#	BACKSET
908506	7/8"
908507	31/32"
908508	1-1/8"
908509	1-1/2"

DEADLATCH (LOCK ONLY)

STOCK#	BACKSET
908516	7/8"
908517	31/32"
908518	1-1/8"
908519	1-1/2"

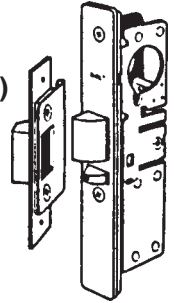

HOOKBOLT (LOCK ONLY)

STOCK#	BACKSET
908511	7/8"
908512	31/32"
908513	1-1/8"
908514	1-1/2"

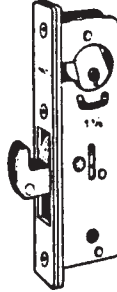

FINISHES:

10	Satin Bronze
27	Satin Aluminum

FACEPLATES ONLY, with screws, for (1" x 6-7/8")—

DEADBOLT	HOOKBOLT	DEADLATCH	DESCRIPTION
908521	908526	908531	FLAT
908522	908527	908532	RADIUS
908523-LHD	908528-LHD	908533-LHD	LEFT-HAND BEVEL
908523-RHD	908528-RHD	908533-RHD	RIGHT-HAND BEVEL
908524	908529	908534	WEATHER STRIP

FACEPLATES	
	FLAT
	RADIUS
	LEFT BEVEL
	RIGHT BEVEL
	RADIUS WITH WEATHERSTRIP

NOTE: To get complete lock, you must order all 3 parts and specify finish.

EX.: 908518 DEADLATCH 1-1/8" BACKSET
908532 RADIUS FACEPLATE
908536 SMALL STRIKE

DEADLATCH STRIKES with mounting plate and screws

STOCK#	DESCRIPTION
908536	SMALL
908537	LARGE

—Being Discontinued—
Limited Supply
CALL FOR CLOSEOUTS PRICES

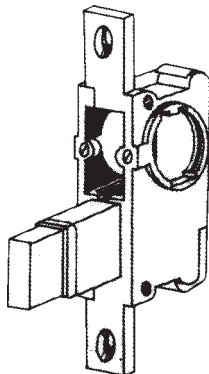
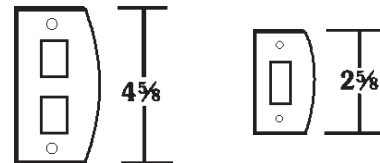

AL-77 Amarlite Lock Replacement

This lock is the only exact replacement for the original Amarlite Telescopic Bolt Lock that can be purchased as a regular stock item on a continual basis. Manufactured to the exact specifications of the Original Amarlite Lock, it allows for a rapid installation and eliminates all need for additional difficult and time consuming alterations to the door.

Locks supplied less cylinders. Cylinder holes are threaded for the Original Amarlite cylinder as well as any standard size mortise cylinders.

CAM LOCKS

TRUCK BODY UTILITY TOOL BOX PLUNGER LOCK

- 5 wafer tumbler cylinder.
- Regularly furnished with 1 key, ES8 keyblank.
- Standard package includes 2 locks KA with 2 keys.
- Regularly furnished with 3/4-24 mounting nut.
- Standard replacement for Contico and Delta Truck Body tool boxes.

Stock No.
ES-1062STD

• **Operation** — Key turns 90° CW allowing spring loaded plunger to be depressed for striking action. Plunger returns to starting position when pressure is released. Key is removable in locked and unlocked position.

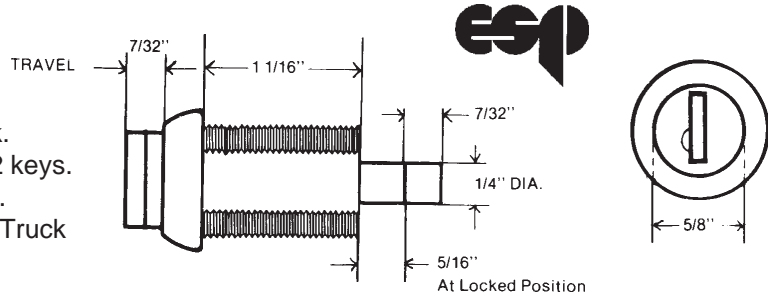

SINGLE BITTED CAM LOCKS

- Single bitted.
- IN8 Keyway.
- Finish: Stainless Steel or brass.
- Two keys furnished per lock.



Contains:
Lock 90° Stop Washer
Cylinder Ring Straight Cam
Spur Washer 1/4" Bent Cam
3/4" Nut 1/4" Nut
180° Stop Washer

STAINLESS STEEL FINISH

Stock No.	A	Keyed Alike Numbers Available
JT-CM7161	7/16"	330, 331, 332, 334
JT-CM0581	5/8"	330, 331, 332, 334
JT-CM0781	7/8"	330, 331, 332, 334
JT-CM1181	1-1/8"	330, 331, 332, 334
JT-CM1381	1-3/8"	330, 331, 332, 334
JT-CM1341	1-3/4"	330, 331, 332, 334

BRASS FINISH

Stock No.	A	Keyed Alike Numbers Available
JT-CM0582	5/8"	330
JT-CM0782	7/8"	330
JT-CM1182	1-1/8"	330
JT-CM1382	1-3/8"	330

Most Locks available **KD**-Keyed Different or **KA**-Keyed Alike. *Specify KD or KA*

TUBULAR CAM LOCKS

- Two keys furnished per lock.

Contains:
Lock 90° Stop Washer
Spur Washer(2) Straight Cam
3/4" Nut 1/4" Bent Cam
180° Stop Washer 1/4" Nut



THUMBTURN CAM LOCKS

CHROME FINISH

Stock No.	A
JT-TT0781	7/8"

Contains:
Lock
Spur Washer
3/4" Nut
90° Stop Washer
Straight Cam
1/4" Bent Cam
Screw



CHROME FINISH

Stock No.	A	Keyed Alike Numbers Available
JT-TB11161	11/16"	1248,0759,7901
JT-TB15161	15/16"	1248,0759,7901
JT-TB19161	1-3/16"	1248,0759,7901
JT-TB23161	1-7/16"	1248,0759,7901

CONVERSION CHART

Jet	Fort	All-Lock	CCL	Chicago	ESP	National
CM7161	MFW23038	C8199			437	C8051
CM0581, 2	MFW23058	C8499	15751	C1725	625	C8052
CM0782, 2	MFW23078	C8599	15752	C1701	875	C8053
CM1181, 2	MFW23118	C8699	15753	C1702	1125	C8054
CM1381, 2	MFW23138	C8799	15760	C1704	1375	C8055
CM1341	MFW23168		15259			C8060
TT0581	MFWTT058				TT625STD	
TT0781	MFWTT078				TT875STD	
TT1181					TT1125STD	
TB11161	MFW1058	C7100		4153		
TB15161	MFW1078	C7200		4152		
TB19161	MFW1118	C7300		4160		
TB23161	MFW1148	C7400		4160-25		

We also stock Jet's Desk Locks, Showcase Locks, Drawer Locks, Mail Box Locks, File Cabinet Locks

©ZIPF LOCK COMPANY

CYLINDERS



Replacement Cylinders

AJ-PTC 12

For American Series 700, Series 1000 and Series 5000 padlocks with protective cover plate. Keyed Alike Numbers Stocked: 22327, 22337, 22347, 43737, 78378.

AJ-PTC 14

6 Pin Cylinder for Series 700, 1000 & 5000. Keyed Alike Numbers Stocked: 52438, 85462.

AJ-HTC 2

For American Tumbler Padlocks Series 7000, KA or KD only. Keyable to ACE, ACEII, Gem Cylinders. Keyed Alike Numbers Stocked: 01034, 01152, 01274.

AJ-BTC 1 KA

For American Blade Tumbler Padlocks available Keyed Alike only (with 2 keys). Keyed Alike Numbers Stocked: D219, D221, D312, D376, D379, D640, E102, E445.

AJ-BTC 1U

For American Blade Tumbler Padlocks Uncoded Cylinders only (less keys).



CYLINDER PLUGS

FOR RE-CK4200 SERIES (6 pin)

488K98- * - **

*Keyway Options: 59A1, 60, 6L4, 981

**Finishes: 605, 626

FOR RE-CK4400 SERIES (6 pin) not CK4429

574K05- * - **

*Keyway Options: 59A1, 60, 6D1, 6L4, 981

**Finishes: 605, 626

FOR RE-CL3400, 3600, 3800 SERIES (6 pin) not CL3429, CL3629.

585K24- * - **

*Keyway Options: 59A1, 60, 6L4, 981

**Finishes: 605, 626

NOTE: Many Corbin-Russwin cylinders are being phased out. Call for closeout prices. See pages 283-287 for Ilco cylinders with Corbin-Russwin keyways.



CT-1

For L66 & L77 locks

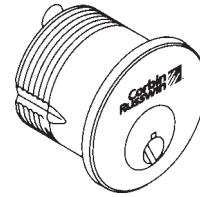

1" MORTISE (5 pin)

1000-100- * -626

*Keyway Options: 5D1, 5L4, 852, 981

1-1/8" MORTISE (6 pin)

1000-118- * - **

*Keyway Options: 6L4, 6D1, 852, 981

**Finishes: 605, 612, 613, 626

TO ORDER, Specify:

Cylinder No.	Keyway	Finish
1000-100	5D1	626

=
1000-100-5D1-626

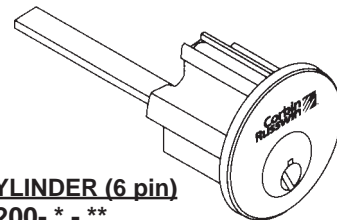

RIM CYLINDER (6 pin)

3000-200- * - **

*Keyway Options: 6L4, 6D1, 852, 981

**Finishes: 605, 626 (6L4 also 612, 613)

852 keyway available in 605 only

TO ORDER, Specify:

Cylinder No.	Keyway	Finish
3000-200	6L4	626

=
3000-200-6L4-626

FILE CABINET LOCKS

DISC TUMBLER FILE CABINET LOCK

APPLICATION—Used internally on filing cabinets to gang lock drawers.

OPERATION—Key removable in locked position only.

KEYING—Keyed only to "Pundra" keyway.

KEY BLANK—D8776.

PACKAGING—Supplied with two keys.

FINISHES—26-Bright Chrome.

CompX
NATIONAL

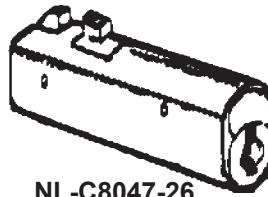

NL-C8047-26

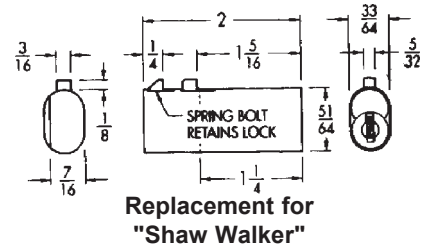

Stock #	Installation	Bolt Type	Cylinder Length	Bolt Travel	Keyed Alike Numbers Available
NL-C8047-26	File Cabinet	Spring	—	1/8"	P141A

Available **KD**-Keyed Different or **KA**-Keyed Alike. *Specify KD or KA*

ES-1750 Series Pin Tumbler File Cabinet Locks



- 4 pin tumbler cylinder.
- Regularly furnished with 2 keys, ES1 key blanks.
- Available keyed alike (KA) or keyed different (KD).

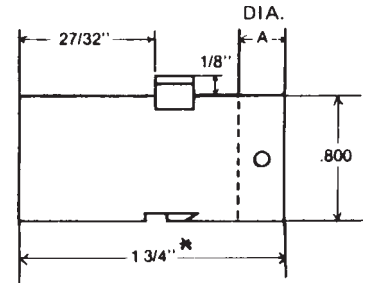
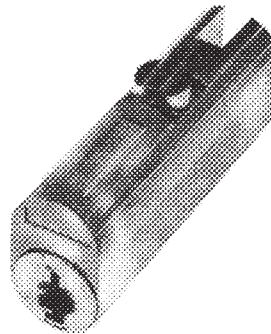
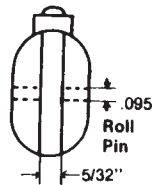
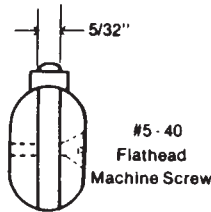

Stock No	Mounting	"A" Dimension	Keyed Alike Number Available
ES-1750P312	roll pin	5/16"	L009
ES-1750S312	machine screw	5/16"	L009
ES-1750P500	roll pin	1/2"	L006
ES-1750S500	machine screw	1/2"	L008

TO ORDER: Specify Stock No. and keying (KA or KD)

NOTE: 312 Series replacement for Hon. Equivalent to Chicago 5001LP.
500 Series replacement for Anderson Hickey. Equivalent to Chicago 5001-50LP.

CHROME FILE CABINET LOCK

- Single bitted.
- Keyway: HL1
- 1-3/4" length.

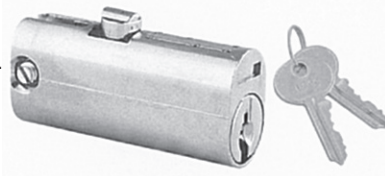

TET

CONVERSION CHART
For **FD1341**:
Chicago: C5001-LP
ESP: 1750S312
National: C8150
For **FR1341**:
ESP: 1750S500

Stock No.	Slot Depth	Keyed Alike Number Available
JT-FD1341	1/2"	L009
JT-FR1341	5/16"	L009

Available **KD**-Keyed Different or **KA**-Keyed Alike.
Specify KD or KA

PRO-LOK®



PK-LTFC9505
Fire Cabinet Lock

Self contained trip lever cylinder lock assembly fits glass fire cabinet doors. Keyed alike LL24.

©ZIPF LOCK COMPANY

KEY ACCESSORIES



MAGNETIC KEY HIDER



Rugged black plastic holds two large keys. Will not rust. Two heavy duty, superior magnets hold to any steel surface. Ideal for use on all vehicles, or any magnetic surface where you want to hide key for emergencies. Supplied in black with silver imprint. Measures 3" x 1-7/8" x 5/8".

Stock No.	Packaging
LKC-91001	1 per card/Minimum of 5 cards.
LKC-91010	10 per metal card display.
LKC-91012	12/box (great for refilling display)

MAGNETIC KEY HIDERS

EXTRA LARGE MAGNETIC KEY HIDER



Rugged plastic case holds even large rubber headed keys. Will not rust. Two heavy duty superior magnets hold to any steel surface. Ideal for use on all vehicles, or any magnetic surface where you want to hide a key for emergencies. Supplied in black with silver imprint. Measures 4" x 2-1/8" x 5/8".

Stock No.	Packaging
LKC-91201	1 per card/Minimum of 5 cards.
LKC-91210	10 per metal card display.
LKC-91200	6/box (great for refilling display)

POUCH KEY HIDER

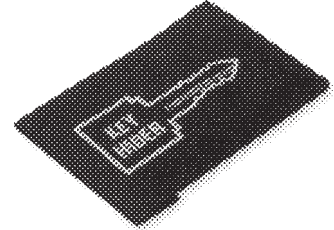

Tear resistant nylon pouch attaches keys or cash to non-magnetic surfaces. Water resistant adhesive anchors mounting pad to any clean surface. Effective hook and loop system secures pouch to pad, makes pouch removal easy. Supplied in black with teal imprint. Measures 2" x 4" x 1/8".

Stock No.	Packaging
LKC-91410	10 per easel card display.

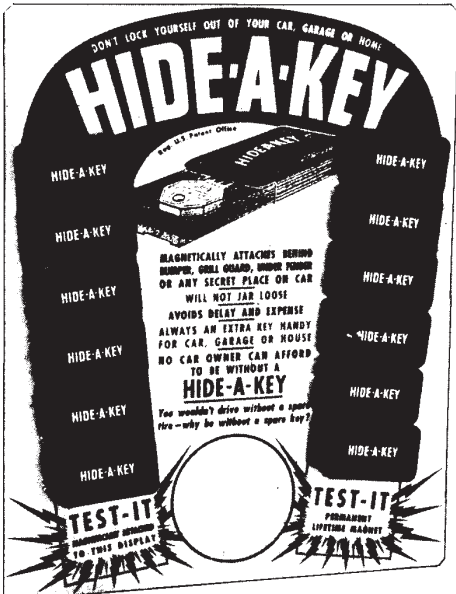

HAK-1 (Pictured above)
Each dozen Hide-A-Keys is magnetically attached to a handsome three color metal counter display stand, size: 11-5/8" X 15-1/8". Metal display stand with one dozen Hide-A-Keys attached packed in individual cartons.
HAK-3 Individually boxed. Sold by the dozen.

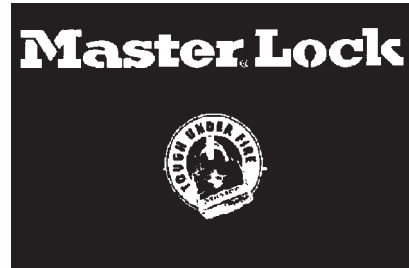

MAGNETIC KEY CASE

Stock No.	Packaging
206DAT	Sold in boxes of 12 only.

For car, home, garage. Use to hide spare key, or as handy coin holder on car dash. Snaps closed. Won't open accidentally. Magnet grips any steel surface. Rust-free case eliminates corrosion of case and key common to conventional all-metal units. Individually blister packed. Measures: 3-1/4" x 2-1/8" x 13/16".

KEY ACCESSORIES



KEY IDENTIFIERS

IDENTA-KEY

Stock No. **Packaging**
IDK-1-8 200 units per display

- 8 Brilliant, flourescent-like colors assure immediate recognition! (red, blue, green, orange, black, brown, grey and yellow)
- A permanent key identification that won't wear out.
- Made of rubber-like vinyl—stretches to fit virtually all key head sizes.

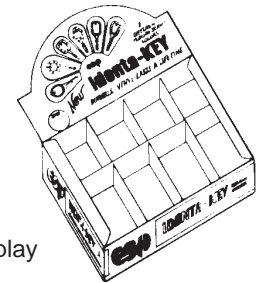
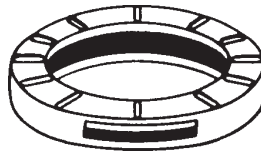
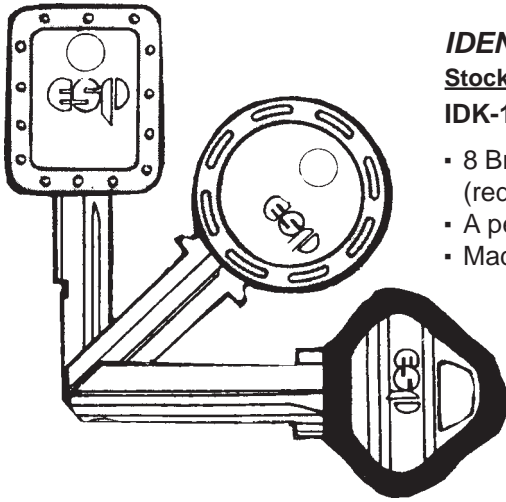

IDK-1 Display

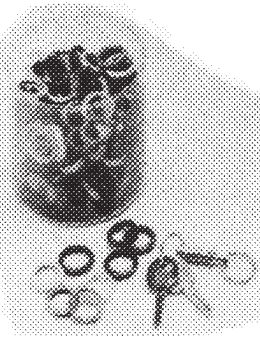

High powered sales in a minimum amount of space. Geared for high impulse sales! We've taken one of our most popular-selling products and packaged it in a eye-catching transparent counter top display. The display measures approximately 3-1/2" X 4".

Stock No. **Description**
ES-BID-200 Indenta Key Rings
 These are the ever-popular vinyl key identifiers. 8 colors, packed 200 per display.

KEY IDENTIFIERS

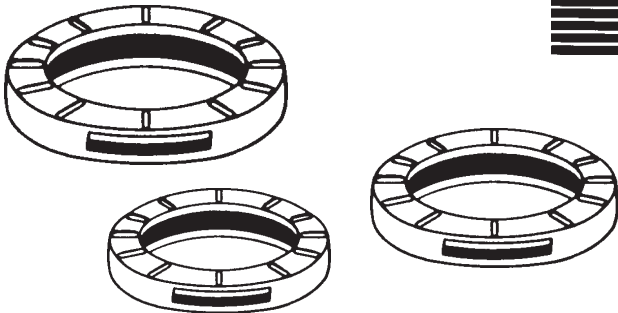

Made of rubber-like vinyl. Key Identifiers will stretch and fit over most key heads. Available in 7 bright colors (red, yellow, green, blue, purple, black and magenta). Packaged 200 pieces per counter display, 25 pieces each color.

Stock No.	Head Size	Packaging
LKC-16400	Small	200/counter display
LKC-16700	Medium	200/counter display
LKC-16615	Large	150/counter display

KEY CAPS

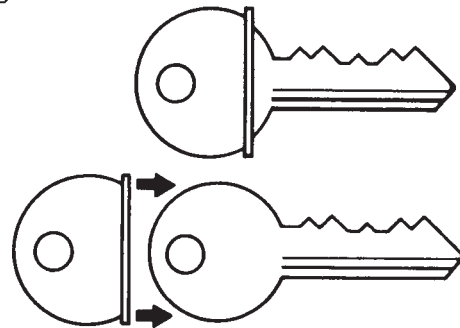

Made of rubber-like vinyl. Key Caps will stretch and fit over round and other key head shapes. Available in 7 bright colors (red, yellow, green, blue, purple, black and magenta). Packaged 200 pieces per counter display, 25 pieces each color.

Stock No.	Packaging
LKC-16500	200/counter display

KEY ACCESSORIES

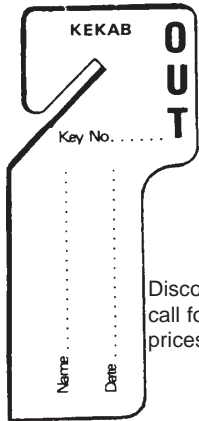

OT-100
OUT TAGS
100 per pack
Sold by the pack

Discontinued—
call for closeout
prices

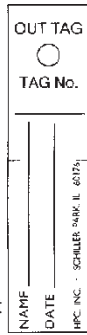

OT-2T
OUT TAGS
20 per pack
Sold by the pack
For 2-tag Kekabs

KEY TAGS

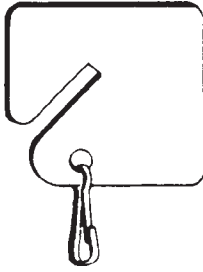

PLT-1
PLASTIC
PLAIN TAGS
100 per pack
Sold by the pack

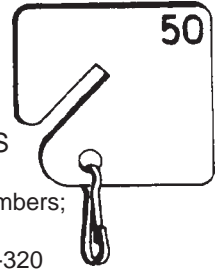

NT-1
NUMBERED TAGS
with Snap Hooks
Packed in series of 20 numbers;
i.e. 1-20, 21-40, etc.
We stock 1-20 thru 301-320

SPECIFY numbers when ordering.
Ex: **NT-1 (41-60)**

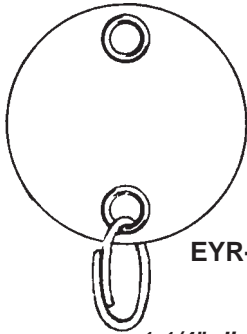

EYR-5

1-1/4" diameter—
Stock No. Description
EYR-5 with 5/8" rings

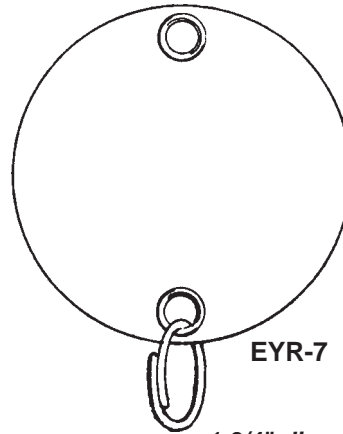

EYR-7

1-3/4" diameter—
Stock No. Description
EYR-7 with 5/8" rings

Packed 100 per box. Tags are white in color except OT-100 are yellow.



Paper key tags (white)
with metal rims.

Stock No.	Diameter
34MR	1-9/16"
35MR	1-7/8"
36MR	2-1/4"

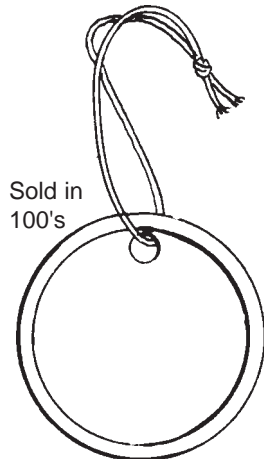

Sold in
100's



Stock No.	Diameter
LKC-27000	15/16"
LKC-27200	1-1/4"

High powered sales in a mini-
amount of space. Geared
for high impulse sales! We've
taken one of our most popular-
selling products and packaged
it in an eye-catching transparent
counter top display. The dis-
play measures approximately
3-1/2" X 4".

Discontinued. Call for closeout price

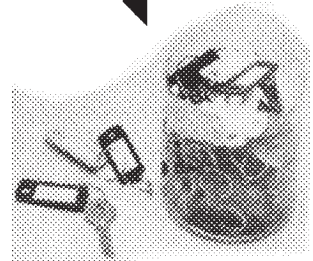

Stock No. Description
\$ES-BKI-72 Key Tag Identifiers
The vinyl tag identifiers are one of the most popular items. 8
colors, packed 72 pieces per eye-catching display.

©ZIPF LOCK COMPANY