

ARROW

D60 SERIES GRADE 1 EXTRA HEAVY DUTY DEADLOCKS



12 locks per case.

US-3 discontinued-
Call for closeout prices

ANSI A156.5, Grade 1

- Two piece housing with free spinning outer ring
- Concealed screws on double cylinder function
- 1" throw, solid steel deadbolt w/hardened steel pin
- 2 strikes supplied, one for steel frame, one for wood frame

SPECIFICATIONS

DOOR THICKNESS: 1-3/8" to 1-3/4"
BACKSET: 2-3/4"
BOLT THROW: 1"
BORE: 2-1/8"
KEYWAY: Arrow "A" drilled for 6 (pinned to 5)
FINISH: **US-3** Polished Brass
US-26D Satin Chrome

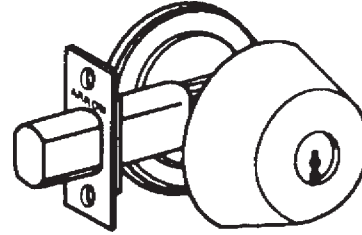

D61 Single Cylinder
D62 Double Cylinder

D60 SERIES GRADE 1 - EXTRA HEAVY DUTY INTERCHANGE- ABLE CORE DEADLOCKS

12 locks per case.

ANSI A156.5, Grade 1

- Same features as D60 Series above.

SPECIFICATIONS

DOOR THICKNESS: 1-3/8" to 1-3/4"
BACKSET: 2-3/4"
BOLT THROW: 1"
BORE: 2-1/8"
KEYWAY: Uses interchangeable core
(not included-order separately)
FINISH: **US-26D** Satin Chrome

*Less cores. See
page 112 for cores.*

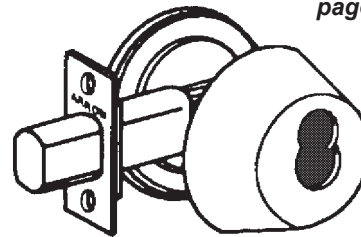

D61-IC Single Cylinder
D62-IC Double Cylinder

E60 SERIES GRADE 2 HEAVY DUTY DEADLOCKS

24 locks per case.

ANSI A156.5, Grade 2

- Two piece housing with free spinning outer ring
- Concealed screws on double cylinder function
- Full 1/4" steel thru-bolts
- 1" throw, solid steel deadbolt w/hardened steel pin
- 2 strikes supplied, one for steel frame, one for wood frame

SPECIFICATIONS

DOOR THICKNESS: 1-3/8" to 1-3/4"
BACKSET: 2-3/8", 2-3/4"
BOLT THROW: 1"
BORE: 2-1/8"
KEYWAY: Arrow "A" drilled for 6 (pinned to 5)
E61, E62 in 3 & 26D also available with "C"
FINISH: **US-3** Polished Brass
US-5A Antique Brass
US-26D Satin Chrome

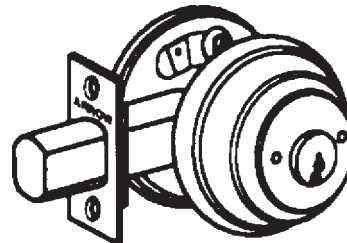

E61 Single Cylinder
E62 Double Cylinder

ASSA

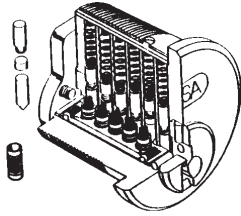

ASSA

WHEN KEY CONTROL AND SECURITY ARE A MUST!!!

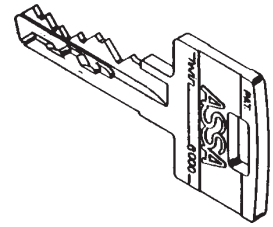

PHYSICAL SECURITY—

PICK RESISTANT. The ASSA Twin resist picking by any commonly known method. Two independent locking mechanisms ensure optimum pick resistance. Inactive “dummy” grooves in the side pins catch the side bar when improperly positioned. When rotational force is applied in a conventional picking attempt, the mushroom-shaped drivers are caught by counter milling in the cylinder plug.

DRILL RESISTANT. Drills are sometimes used to destroy brass cylinders and open locks. Vital points in the ASSA Twin/6000 and Twin Exclusive cylinders are protected by case-hardened, drill resistant inserts. All pins are nickel silver or stainless steel.

KEYS AND KEY CONTROL—

The ASSA Twin/6000 and Twin Exclusive keys are precision-crafted security tools. Two sets of bittings, or key cuts, operate the double locking mechanisms. Detail and quality are evident. Even the back of the keys are rounded for smooth operation and minimal wear. The enlarged key bow accommodates use by manually impaired people, and the unusual strength of the key virtually eliminates breakage.

The ingenious design of the ASSA Twin/6000, Twin Exclusive deadlocks and cylinders have earned patents in the United States and many other countries. Patents are crucial in the effort to eliminate unauthorized duplicate keys and maintain key control. **Any infringement of the ASSA patent rights will be forcefully defended in the courts.**

THE ALPHA SYSTEM (Twin/6000) AND ALPHA TWIN EXCLUSIVE (TE)

Four key control programs featuring the ASSA Twin/6000 and Twin Exclusive Cylinders.

<u>Twin/6000</u>	<u>Twin Exclusive</u>	
DELTA	TED	Zipf Lock Company Distributor's keyway
GAMMA	TEL	Locksmith keyways with local area restriction. Initial order required*
BETA	TER	Locksmith keyways with extended regional restriction. Initial order required*
ALPHA	TEE	Regional or Nationally exclusive keyways for large end-users.*

*Written agreement and initial order required. Contact us for details.

SECURITY DEADLOCKS WITH TWIN/6000 SERIES OR EXCLUSIVE KEYWAY

ASSA

FEATURES:

- ASTM F 1577 6.6 Certified, Grade 1
- U.L. 437
- Hardhat™ to prevent physical attack
- Hardened bolt with full 1" throw
- Free spinning guard collars to prevent wrenching
- 1/4" Aircraft strength steel mounting bolts
- High Security solid brass ASSA cylinder
- Patented key control

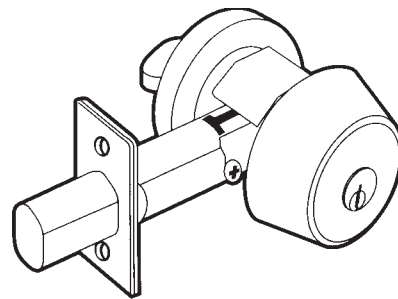

NEW

SPECIFICATIONS

DOOR THICKNESS: 1-3/8" to 2"
BACKSET: 2-3/4"
BOLT THROW: 1"
BORE: 1-3/4"
 (Will work in 2-1/8" bore)

FINISHES:
605 Bright Brass
626 Satin Chrome

Twin/6000		Twin Exclusive
<u>Keyway</u>	<u>Function</u>	<u>Keyway</u>
6000	Single Cylinder	E6000
6000DC	Double Cylinder	E6000DC
•All sub-assembled, no sidebar(SNS)		

•Also available in more restricted keyways. Call for details.

©ZIPF LOCK COMPANY

CAL-ROYAL

CRB800 SERIES

Maximum Security Heavy Duty Deadbolt

- ANSI A156.5, Grade 1.
- 1-year Mechanical Warranty.
- 1" Throw High Strength Steel Alloy Deadbolt With 1/4" Free Spinning Anti-saw Pin.
- Free Turning, Wrench-resistant Tapered Cylinder Ring.
- Cylinder Recesses Into Door to Resist Blows Attempting to Move the Lock.
- Steel Plate Mounting.
- Strike: 3" Screws with Wood Frame Reinforcer Greatly Strengthens Door Frames.
- **Solid Brass 6-pin Cylinder. "C" Keyway.**

SPECIFICATIONS

DOOR THICKNESS: 1-3/8" to 2-1/8"
BACKSET: 2-3/4" square corner face.
STRIKE: Square corner, 1-1/8" x 2-3/4" with 3" screws.
BOLT THROW: 1"
BORE: 2-1/8" x 1"
KEYWAY: 6 pin solid brass "C" keyway
 Furnished keyed different (KD)
I/C: Will accept 6 or 7 pin Best, Arrow or Falcon cores.
FINISHES: **US3(605)** Bright Brass
10B(613) Oil Rubbed Bronze
26D(626) Satin Chrome

I/C stocked in 26D finish only.

CAL-ROYAL

20 locks per case

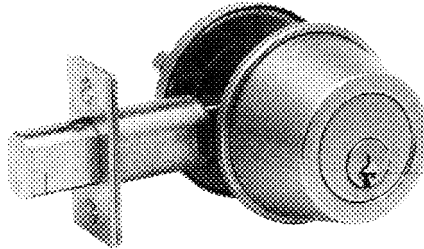

With Standard Cylinder—

Stock No.	Description
CRB-800	Single Cylinder
CRB-700	Double Cylinder

**For Interchangeable Core—

Stock No.	Description
IC-CRB-800	Single Cylinder
IC-CRB-700	Double Cylinder

****Cores not included - order separately.
See below for cores.**

To Order, Specify:

Function: **CRB800** Single Cylinder
 Finish: **US3** Bright Brass
 Latch: **234** 2-3/4" Backset
 • All locks are stocked **Keyed Different (KD)**
 • Interchangeable Core only available in 26D finish.

Stock No.	Length
AR-C6S-UC	6 pin
AR-C7S-UC	7 pin

Keyways: 1D, AB, BB, DB, EB, FB, GB, HB, JB, KB, MB.

Finishes: **4**-Satin Brass
26D-Satin Chrome

To Order, Specify:
 Stock No. Keyway and Finish (AR-C6S-UC AB 26D)



CHELSIE SERIES

Residential Duty

- ANSI A156.2, Grade 3.
- 25-year Mechanical Warranty.
- 5-year Finish Warranty.
- All metal body & cylinder construction.
- All exterior parts are brass.
- **Kwikset Keyway. Re-keyable for Master and Construction Keying.**

To Order, Specify:

Function: **CH-ED500** Single Cylinder
 Finish: **US10B** Oil Rubbed Bronze
 Latch: **RCAL** Adjustable R.C.
 • All locks are stocked **Keyed Alike (KA3)**

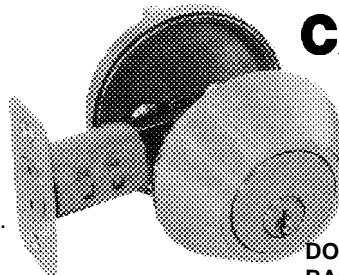

CAL-ROYAL

24 locks per case

Stock No.	Description
CH-ED-500	Single Cylinder
CH-EDD-400	Double Cylinder

SPECIFICATIONS

DOOR THICKNESS: 1-3/8" to 1-3/4"
BACKSET: Adjustable 2-3/8" or 2-3/4" with round corner face.
STRIKE: Full Lip, Round corner, 1" x 2-3/4"
BOLT THROW: 1" w/hardened steel pin to prevent saw cutting.
BORE: 2-1/8" x 1"
KEYWAY: Kwikset 81063 (KW1)
 Locks furnished KA-3
FINISHES: **US3(605)** Bright Brass
5(609) Antique Brass
10B(613) Oil Rubbed Bronze
15(619) Satin Nickel
15A(620) Antique Nickel
26(625) Bright Chrome
26D(626) Satin Chrome

©ZIPP LOCK COMPANY

CAL-ROYAL

T300 SERIES

Heavy Duty Deadbolt

- ANSI A156.5, Grade 2.
- 1-year Mechanical Warranty.
- 1" Throw High Strength Steel Alloy Deadbolt With Anti-saw Pin
- Cylinder Recesses Into Door to Resist Blows Attempting to Move the Lock.
- **Solid Brass 6-pin Cylinder. "C" Keyway.**

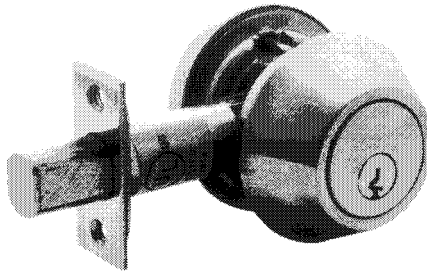

20 locks per case

CAL-ROYAL

Stock No. Description

***T360** Single Cylinder

***T362** Double Cylinder

*Limited supply. Replaced by ULT

Stock No. Description

ULT360 Single Cylinder

ULT362 Double Cylinder

SPECIFICATIONS

DOOR THICKNESS: 1-3/8" to 1-3/4"

BACKSET: Adjustable 2-3/8" or 2-3/4" with square corner face.

STRIKE: Square corner, 1-1/8" x 2-3/4"

BOLT THROW: 1"

BORE: 2-1/8" x 1"

KEYWAY: 6 pin solid brass "C" keyway
Furnished keyed different (KD)

FINISHES: **US3**(605) Bright Brass
10B(613) Oil Rubbed Bronze
26(625) Bright Chrome
26D(626) Satin Chrome

Because this is a rolling change over to the ULT deadlocks, there could be limited availability.

To Order, Specify:

Function: **T360** Single Cylinder

Finish: **US3** Bright Brass

Latch: **AL** Adjustable S.C.

• All locks are stocked Keyed Different (KD)

LSD SERIES

Standard Duty Deadbolt

- ANSI Grade 3.
- 1-year Mechanical Warranty.
- 1" Throw Bolt With 1/4" Free Spinning Anti-cut Through Pin.
- Rotating Trim Ring.
- **Solid Brass 6-pin Cylinder. "C" Keyway. Rekeyable for Construction Keying.**

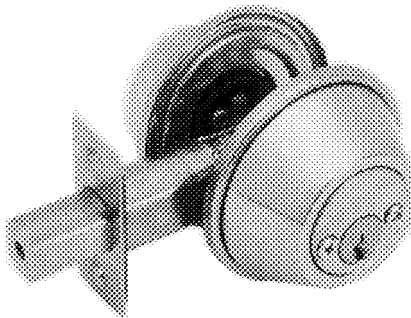

20 locks per case

CAL-ROYAL

Stock No. Description

LSD-01 Single Cylinder

LSD-88 Double Cylinder
(pictured)

SPECIFICATIONS

DOOR THICKNESS: 1-3/8" to 1-3/4"

BACKSET: Adjustable 2-3/8" or 2-3/4" with square corner face.

STRIKE: Square corner, 1-1/8" x 2-3/4"

BOLT THROW: 1"

BORE: 2-1/8" x 1"

KEYWAY: 6 pin solid brass "C" keyway
Furnished keyed different (KD)

FINISHES: **US3**(605) Bright Brass
10B(613) Oil Rubbed Bronze
32D(630) Stainless Steel

To Order, Specify:

Function: **LSD-01** Single Cylinder

Finish: **US3** Bright Brass

Latch: **AL** Adjustable S.C.

• All locks are stocked Keyed Different (KD)

CORBIN/RUSSWIN

STANDARD DUTY KNOB CK4400 SERIES

FEATURES:

- ANSI A156.2 Series 4000, Grade 2;
- U.L. Listed
- Reversible

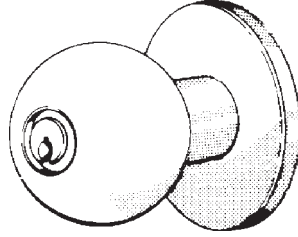

**GLOBAL
(GWC)**
613, 630

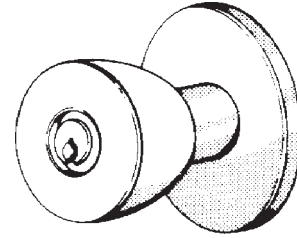

**BELMONT
(BWC)**
605, 612, 630

SPECIFICATIONS

DOOR THICKNESS: 1-1/4" to 1-3/4"

BACKSET: 2-3/4" square face

STRIKES: Global—ASA
Belmont—"T" type

BORE: 2-1/8" x 1"

ROSE: 3"

KEYWAYS: D1, L1 or 981

FINISHES: **605** Bright Brass

612 Satin Bronze

613 Dark Oxidized Satin Bronze,
oil rubbed

630 Satin Stainless Steel

*Call for GREAT
closeout prices.*

HOW TO ORDER: Specify,

Function:	RE-CK4451	Entrance
Design:	GWC	Global Design
Finish:	630	Satin Stainless Steel
Keyway:	D1	D1 keyway

Function

PASSAGE **\$CK4410**

Operation

Deadlocking latchbolt by knob either side. Both knobs always free. **(ANSI F75)**

PRIVACY **\$CK4430**

Deadlocking latchbolt by knob either side. Outside knob locked by push button. Outside knob unlocked by turning slotted button outside, by rotating inside knob, or by closing door. **(ANSI F76)**

ENTRANCE **\$CK4451**

Deadlocking latchbolt by either knob, except when turn button locks outside knob. Pushing turn button in locks outside knob, requiring use of key outside to unlock. Turning inside knob unlocks outside knob. Pushing in and turning button locks outside knob, requiring key at all times. Turning inside knob does not unlock outside knob until button is manually turned to unlocked position. Inside knob always free. **(ANSI F81)**

**We still stock:
CK4451 GWC 630 D1**

CLASSROOM **\$CK4455**

Deadlocking latchbolt by knob either side, except when key outside locks outside knob. When outside knob is locked, latchbolt is operated by key outside or by rotating inside knob. Inside knob always free. **(ANSI F84)**

STOREROOM **\$CK4457**

Deadlocking latchbolt by key in outside knob, or by rotating inside knob. Outside knob always rigid. Inside knob always free. **(ANSI F86)**

CYLINDRICAL DEADLOCKS DL3000 SERIES

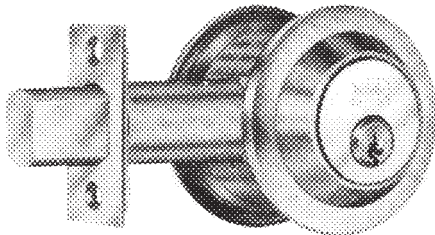

\$DL3011 Single Cylinder (Key outside/blank plate inside)

\$DL3012 Double Cylinder

DOOR THICKNESS: 1-3/4"

BACKSET: 2-3/4"

BORE: 2-1/8"

BOLT THROW: 1"

CYLINDER: Mortise

KEYWAYS: D1, L4

FINISH: **613** Dark Oxidized Satin Bronze, Oil Rubbed

626 Satin Chromium Plated

Call for GREAT closeout prices.

HOW TO ORDER: Specify,

Function:	RE-DL3013	Single Cylinder
Finish:	626	Satin Chromium Plated
Keyway:	D1	D1 keyway

©ZIPP LOCK COMPANY

NOTE: Many Corbin-Russwin locks are being phased out. We also have Schlage with Corbin-Russwin keyways.

**141 v1
(PL-5)**

DEXTER

J SERIES DEADBOLT

DEXTER
by SCHLAGE

24 Locks per case

For Residential Use

- ANSI A156.5, 1992, Grade 3.
- Residential 25-year Mechanical Warranty.
- Residential 5-year Finish Warranty.
- Rekeyable to Schlage Locks.
- Easy To Install.

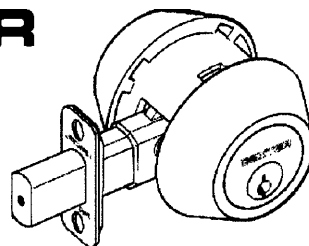

Function	No.	Operation	ANSI
SINGLE CYLINDER	JD60	Deadbolt thrown or retracted by key from outside or by inside turn unit. Bolt automatically deadlocks when fully thrown.	E2153
DOUBLE CYLINDER	JD62	Deadbolt thrown or retracted by key from either side. Bolt automatically deadlocks when fully thrown.	E2143

To Order, Specify:

Function: **JD60** *Single Cylinder*
 Finish: **605** *Bright Brass*
 Latch: **AL** *Adjustable Latch*

SPECIFICATIONS

DOOR THICKNESS: 1-3/8" to 1-3/4"
BACKSET: AL-Adjustable for 2-3/8" or 2-3/4" with square and round corner face plates (16-048).
STRIKE: Square corner strike (1-1/8" x 2-3/4").
BORE: 2-1/8" x 1"
KEY BLANK: J750-000
KEYWAY: Schlage C Keyway, 5-pin
FINISHES:
605(US-3) Bright Brass
609(US-5) Antique Brass
619 (US-15) Satin Nickel
620 (US-15A) Antique Pewter
625 (US-26) Bright Chrome
630(US-32D) Satin Stainless Steel
716 New Aged Bronze



J SERIES HANDLESET

4 Locks per case

For Residential Use

- ANSI A156.2, 1996, 4000 Series, Grade 3.
- Residential 25-year Mechanical Warranty.
- Residential 5-year Finish Warranty.
- Rekeyable to Schlage Locks.
- Easy To Install.

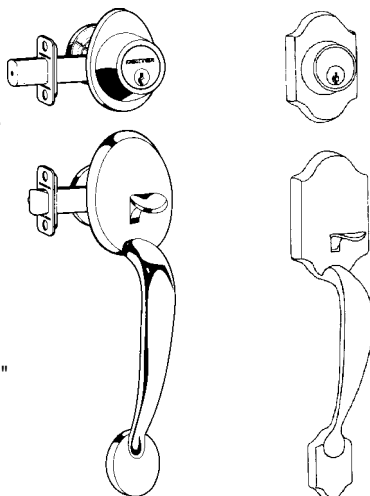

BARCELONA (BAR)

PARIS (PRS)

Center of handle hole to mounting screw: 8-5/8"

Interior Packs

JH59 For Locking Handles

Interior Pack Designs

BRY 605,609,630

CNA 605,609,619,620,625,630

DOV 605,609,630

LAS 605,609,619,620,625,630,716

MAR 605,609,619,620,625,630

STR 605,619,716

TOR 605,609,619,620,625,630,716

To Order, Specify:

For handle-(exterior only)

Handle No.: **JH58 PRS**

Finish: **619**

For interior pack-(Listed above)

Interior No.: **JH59**

Design: **LAS**

Finish: **619**

*Handing: **LH**

*Required on LAS lever design.

DOOR THICK.: 1-5/8" to 1-3/4"
BACKSET: AL-Adjustable for 2-3/8" or 2-3/4" with square and round corner face plates.
STRIKE: Square corner strike (1-1/8" x 2-3/4") for deadbolt. 1/4" Radius full lip for bottom latch. 2-1/8" x 1"
BORE: 2-1/8" x 1"
KEY BLANK: J750-000
KEYWAY: Schlage C Keyway, 5-pin
FINISHES:
605(US-3) Bright Brass
609(US-5) Antique Brass
619 (US-15) Satin Nickel
620 (US-15A) Antique Pewter
625 (US-26) Bright Chrome
630(US-32D) Satin Stainless Steel
716 New Aged Bronze

Function Description

JH58 Locking Handle Exterior

JH59 Locking Handle Interior

JH193 Dummy Handleset w/interior*

*BAR exterior; BRY, CNA, LAS or STR interiors only.

©ZIPF LOCK COMPANY

ILCO



4500 SERIES BARRIER MORTISE CYLINDER DEADLOCK

- Patented deadlock with 1" throw bolt
- Heavy duty cylinder housing
- Heavy duty reinforced strike
- Bolt and housing interlock for maximum strength
- No exposed screws on double cylinder model
- Reinforced, tapered, free spinning collars
- Armored front shields cylinder set screws
- Uses solid brass mortise cylinders with Adams-Rite Cam
- Accepts virtually all manufacturers' mortise cylinders—conventional, interchangeable core or high security
- Two hardened steel rods in bolt resist sawing

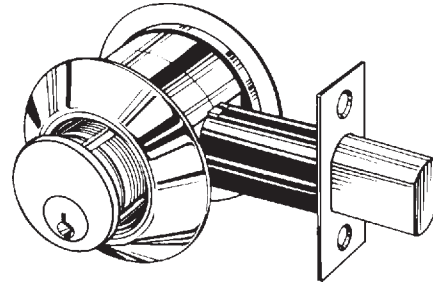

SPECIFICATIONS	
DOOR THICKNESS:	1-3/8" to 1-3/4"
BACKSET:	2-3/8", 2-3/4"
BORE:	2-1/8" x 1"
BOLT THROW:	1"
CYLINDER:	Brass, 1"
FINISHES:	03 Bright Brass 10B* Oil-Rubbed Bronze 26D Satin Chrome *Limited supply

Single Cylinder

LOR-4513	2-3/8"
LOR-4514	2-3/4"
LOR-4515	2-3/8" Drive-in
LOR-4516	2-3/4" Drive-in

Double Cylinder

LOR-4523	2-3/8"
LOR-4524	2-3/4"
LOR-4525	2-3/8" Drive-in
LOR-4526	2-3/4" Drive-in

We stock locks with cylinder(s)...

To Order, Specify:

Function: **4513** Sgl, 2-3/8"
Finish: **-03** Polished Brass
Cylinder: **-04** Schlage Keyway

We stock the following keyways as complete locks: SC, YA. They have 5 pin cylinder(s). *Limited with YA keyway.*

<u>Keyway</u>	<u>Keyway</u>
-AA Arrow	-RB Russwin D1
-CA Corbin 60	-SC Schlage C
-CD Corbin 59A1-A2	-SE Schlage E
-CE Corbin/Russwin L4	-SX Schlage C/K
-FA Segal 9 (1022)	-UA Ilco X1054K
-GA Sargent LA	-UE Kaba 80
-GB Sargent LA-LC	-WA Weiser 1555
-GC Sargent RA-RC	-XE Dexter 67
-KS Kwikset (1176)	-YA Yale 8
-LA Lockwood 1004	-YG Yale GA
-NB Composite HR1*	
-RA Russwin 5981	

*Can be keyed to Sargent U & S, Weslock, Harloc, SE1 and Lori L200. 1st pin at .216"

• Keyways available subject to change •

...OR without cylinders

To Order Lock, Specify:

Function: **4513** Sgl, 2-3/8"
Finish: **-03** Polished Brass
Keyway: **-00** Less Cylinder

Cylinders—(if needed)

To Order Cylinder, Specify:

Cylinder: **7185** For Single Cylinder
Keyway: **-CA2** Corbin 60
Finish: **-03** Polished Brass

To Order Cylinders, Specify:

Cylinder: **7185** For Double Cylinder
Keyway: **-CA2** Corbin 60
Finish: **-03** Polished Brass
-KA2 2 cylinders K.A.

We stock the cylinders in the keyways listed at left. YOU MUST USE AN ADAMS RITE CAM WITH THESE CYLINDER-ORDER SEPARATELY if needed. These cylinder are 1-1/8", drilled 6 pin but keyed to 5.

KWIKSET

980S SERIES DEADBOLTS

- ANSI A156.5, Grade 1.
- Titanium Alloy Throwbolt Core.
- Ultra-Strike Door Jamb Brace.
- Solid Steel Latch Face.
- Anti-Pick 6-pin Cylinder.
- Lifetime Mechanical Warranty.
- 10-year Finish Warranty.
- Lifetime Finish on LO3 finish.

Kwikset
UltraMax
Signatures

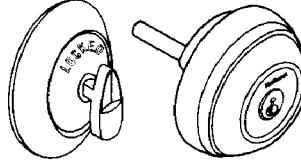

12 locks per case.

Interior turnpiece meets
4.13.9 ADA requirements



980S Single Cylinder
US-LO3, 5, 11P, 15, 15A, 26, 26D

985S Double Cylinder
US-LO3, 5, 11P, 15, 15A, 26, 26D

	SPECIFICATIONS
DOOR THICKNESS:	1-3/4"
BACKSET:	Adjustable for 2-3/8", 2-3/4" with round corner face
STRIKE:	1-1/4" x 3-5/8" round corner
BORE:	2-1/8" or 1-1/2" x 1"
CYLINDER:	6-pin, includes 3 anti-pick pins
KEY BLANK:	KW-81208 (KW-88260)
FINISHES:	US-LO3 (605E) Polished Brass-Lifetime
	US-5 (609) Antique Brass
	US-11P Venetian Bronze
	US-15 (619) Satin Nickel
	US-15A (620) Antique Nickel
	US-26 (625) Polished Chrome
	US-26D (626) Satin Chrome

No.	Description
980S	Single Cylinder: Deadbolt operated by key outside or thumbturn inside.
985S	Double Cylinder: Deadbolt operated by key both sides.

To Order, Specify:

Function: **980S** *Single Cylinder*
 Finish: **US-11P** *Venetian Bronze*
 *Latch: **RCAL** *Adjustable*
 *2-3/8" or 2-3/4" adjustable deadbolt Round Corner latch.

780 SERIES DEADBOLTS

- ANSI A156.5 Grade 2.
- Maximum Security, Heavy Gauge Strike with Extra Long 3" Screws.
- Compatible with Kwikset's 5 Pin Keying Systems.
- Lifetime Mechanical Warranty.
- 10-year Finish Warranty.
- Lifetime Finish Warranty on **LO3** Finish.

Kwikset
UltraMax
Signatures

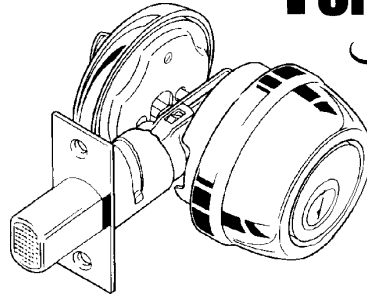

12 locks per case.

Interior turnpiece meets
4.13.9 ADA requirements



780 Single Cylinder
US-LO3, 3, 5, 10B, 11P, 15, 15A, 26, 26D

785 Double Cylinder
US-LO3, 3, 5, 10B, 11P, 15, 15A, 26, 26D

	SPECIFICATIONS
DOOR THICKNESS:	1-3/8" to 1-3/4"
BACKSET:	Adjustable for 2-3/8", 2-3/4"
BORE:	2-1/8" or 1-1/2" x 1"
CYLINDER:	6-pin
KEY BLANK:	KW-81208 (KW-88260)
FINISHES:	US-LO3 (605E) Polished Brass-Lifetime
	US-3 (605) Polished Brass
	US-5 (609) Antique Brass
	US-10B (613) Oil Rubbed Bronze
	US-11P Venetian Bronze
	US-15 (619) Satin Nickel
	US-15A (620) Antique Nickel
	US-26 (625) Polished Chrome
	US-26D (626) Satin Chrome

No.	Description
780	Single Cylinder: Deadbolt operated by key outside or thumbturn inside.
785	Double Cylinder: Deadbolt operated by key both sides.

To Order, Specify:

Function: **785** *Double Cylinder*
 Finish: **US-3** *Polished Brass*
 *Latch: **SCAL** *Adjustable Latch*
 *2-3/8" or 2-3/4" adjustable deadbolt latch is standard.
 Specify **RCAL** for Round Corner Adjustable Latch.
 Specify **SCAL** for Square Corner Adjustable Latch.
 Specify **RFAL** for Round Face Adjustable Latch.

©ZIPF LOCK COMPANY

KWIKSET

TOUCHPAD ELECTRONIC DEADBOLT

Powerbolt Deadbolts

- 1" projection deadbolt latch with 1/4" diameter hardened steel free-turning roller.
- Easy to Install, Easy to Program, Easy to Use.
- Requires 4 "AA" alkaline batteries (not included).
- Residential 1-Year Electrical components warranty.
- Residential Lifetime Mechanical warranty.
- Residential 5-year Finish warranty.
- Residential Lifetime Finish warranty on LO3.

Electronic Keyless Entry System

- Simply enter your personalized access code for convenient, quick and care-free entry.
- You may also program a temporary second code for a neighbor, cleaning crew, etc.
- Alarm sounds after 3 consecutive incorrect codes are entered.
- Easy-one touch locking.
- Heavy duty security deadbolt and strike plate resist break-ins.
- No wiring necessary (add 4 Alkaline "AA" batteries).
- Low battery indicator.
- Fits standard preparation on new doors.
- Easily replaces existing door hardware.

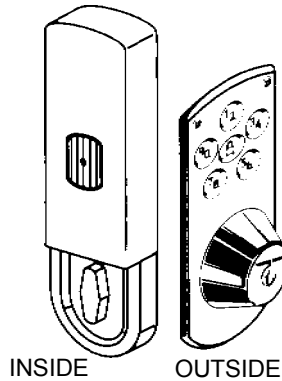

SPECIFICATIONS

DOOR THICKNESS: 1-3/8" to 2"
BACKSET: Adjustable 2-3/8" to 2-3/4"
BORE: 2-1/8" x 1"
BOLT THROW: 1"
FINISHES: **US-LO3** Bright Brass - Lifetime
US-11P Venetian Bronze
US-15 Satin Nickel

HOW TO ORDER: Specify,

Function: **907** Single Cylinder
Finish: **US-LO3** Bright Brass
Latch: **AL** Adjustable

Stock No. Operation

907 Single Cylinder Deadbolt-
 Deadbolt latch retracted by entering security code outside and extended by pushing lock button outside. Deadbolt latch extended and retracted by T-Turn on inside. Using key outside will retract deadbolt latch if needed.

970 SERIES DEADBOLTS

- ANSI A156.5, Grade 2.
- Full 1" Nickel Plated Steel Bolt.
- Solid Steel Strike.
- 5-pin cylinder.
- Lifetime Mechanical Warranty.
- 5-year Finish Warranty.
- Lifetime Finish Warranty on LO3 Finish.



12 locks per case.



Interior turnpiece meets 4.13.9 ADA requirements

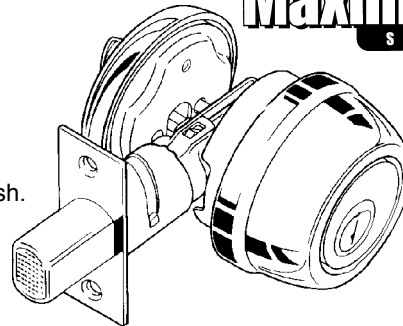

970 Single Cylinder

US-L03, 3, 5, 11P, 15, 15A, 26, 26D

975 Double Cylinder

US-L03, 3, 5, 11P, 15, 15A, 26, 26D

DOOR THICKNESS: 1-3/8" to 1-3/4"
BACKSET: Adjustable for 2-3/8", 2-3/4"
BORE: 2-1/8" or 1-1/2" x 1"
CYLINDER: 5-pin
KEY BLANK: KW-81063
FINISHES: **US-LO3** (605E) Polished Brass-Lifetime
US-3 (605) Polished Brass
US-5 (609) Antique Brass
US-11P Venetian Bronze
US-15 (619) Satin Nickel
US-15A (620) Antique Nickel
US-26 (625) Polished Chrome
US-26D (626) Satin Chrome

No. Description

970 Single Cylinder: Deadbolt operated by key outside or thumbturn inside.
975 Double Cylinder: Deadbolt operated by key both sides.

To Order, Specify:

Function: **975** Double Cylinder
Finish: **US-3** Polished Brass
***Latch:** **AL** Adjustable

*2-3/8" or 2-3/4" adjustable deadbolt latch is standard.
 Specify **RCAL** for Round Corner Adjustable Latch.
 Specify **SCAL** for Square Corner Adjustable Latch.
 Specify **RFAL** for Round Face Adjustable Latch.

KWIKSET

660 SERIES DEADBOLTS

- ANSI A156.5, Grade 3.
- Limited Lifetime Mechanical Warranty
- 5-year Finish Warranty

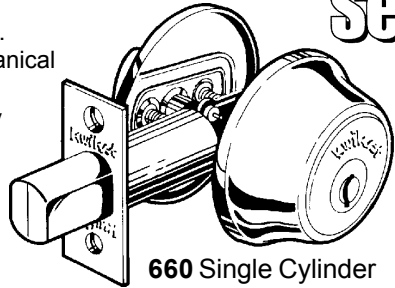

660 Single Cylinder
US-3, 5, 11P, 15, 15A, 26, 26D

Kwikset Security

12 locks per case.

Interior turnpiece meets 4.13.9 ADA requirements

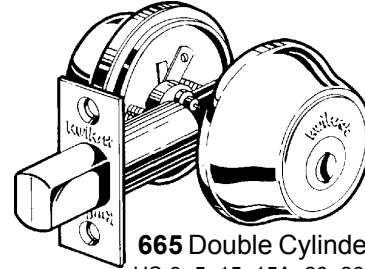

665 Double Cylinder
US-3, 5, 15, 15A, 26, 26D

No. Description

660 Single Cylinder: Deadbolt operated by key outside and thumbturn inside.

663 Thumbturn Only: Deadbolt operated by thumbturn one side. No trim on other side.

665 Double Cylinder: Deadbolt operated by key both sides.

667 Thumbturn x Plate: Deadbolt operated by thumbturn on interior. Blank plate on exterior.

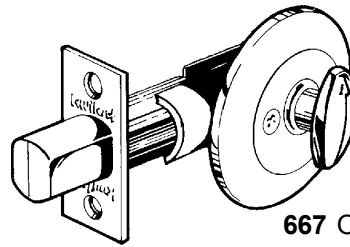

663 One Sided (Pictured)
US-3, 5, 15, 15A, 26D

667 One Sided w/Exterior Plate
US-3, 26D

SPECIFICATIONS

DOOR THICKNESS:	1-3/8" to 1-3/4"
BACKSET:	Adjustable for 2-3/8", 2-3/4" 663 has 2-3/8" fixed latch
STRIKE:	1" x 2-1/4"
BORE:	2-1/8" x 1" 1-5/8" x 1" (For 663 Lock) 2-1/8" or 1-1/2" x 1" (For 667 Lock)
CYLINDER:	5-pin
KEY BLANK:	KW-81063
FINISHES:	US-3 (605) Polished Brass US-5 (609) Antique Brass US-11P Venetian Bronze US-15 (619) Satin Nickel US-15A (620) Antique Nickel US-26 (625) Polished Chrome US-26D (626) Satin Chrome

KW-664 Conversion Kit US-3, 5, 26D

To convert a 663 to a 667. Kit has Exterior Plate, screws and torque blade.

To Order, Specify:

Function: **665 Double Cylinder**

Finish: **US-3 Polished Brass**

*Latch: **SCAL Adjustable Latch**

*2-3/8" or 2-3/4" adjustable deadbolt latch is standard.

Specify **RCAL** for Round Corner Adjustable Latch.

Specify **SCAL** for Square Corner Adjustable Latch.

Specify **RFAL** for Round Face Adjustable Latch.

COMBO PACKS

- Limited Lifetime Mechanical Warranty.
- 5-year Finish Warranty.
- 5-Pin Cylinder.
- Key Blank: KW-81063

Contains:

- 1 deadlock (660/665) and 1 entry lock (400P/400T), keyed alike.
- Adjustable latches— 2-3/8" or 2-3/4"
- Round Corner Strikes (RCS).
- Sets available Keyed in 2's (KA-2)

Kwikset Security

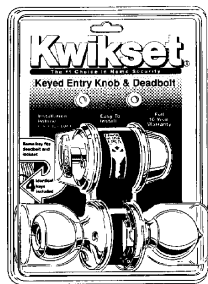

Limited supply of clear pack available. Only box pack will be available

6 locks per case.

KEYED ENTRY KNOB...

W/Single Cylinder Deadlock

690P 3 6AL Polo in Polished Brass

\$690P 5 6AL Polo in Antique Brass

690P 15 6AL Polo in Satin Nickel

690T 3 6AL Tylo in Polished Brass

W/Double Cylinder Deadlock

\$695P 3 6AL Polo in Polished Brass

\$695T 3 6AL Tylo in Polished Brass

\$695T 5 6AL Tylo in Antique Brass

\$ Item discontinued. Call for closeout price.

©ZIPF LOCK COMPANY

SCHLAGE

6 locks per case

BE SERIES ELECTRONICS

Keypad Deadbolts

- Grade 2 ANSI/BHMA certified.
- ANSI A156.5-2001 Grade 2 auxiliary locks.
- Residential Lifetime Mechanical Warranty.
- Residential Lifetime Finish Warranty.
- FCC Part 15, CE Mark.



BE365 with Turn-Lock Feature

Schlage Keypad Deadbolts bring professional grade security with the convenience of keyless access to the home. The innovative Turn-Lock feature allows the user to lock and leave without a key. Ideal for front, back and side entry doors where deadbolts are required.

Security and Quality

- Grade 2 ANSI/BHMA certified
- Patented commercial grade clutching motor drive: tested to one million cycles.
- Vandal resistant free spinning deadbolt turn.
- Code control, 6-digit programming code required to add and delete user codes.
- Warning code sounds after 4 incorrect codes entered; keypad disabled for 30 seconds.
- Mechanical key override: patent pending.

Convenience

- Convenient keyless access; no keys to hide, lose or forget.
- Pre-set with random 6-digit programming code and two random 4-digit user codes.
- 19 user code capacity; 10,000 user code combinations.
- Easily programmed right at the keypad; no need to remove inside escutcheon.
- Blue LEDs illuminate the keypad on demand.
- Locks can be rekeyed to match existing locks.
- 9-volt alkaline battery included.

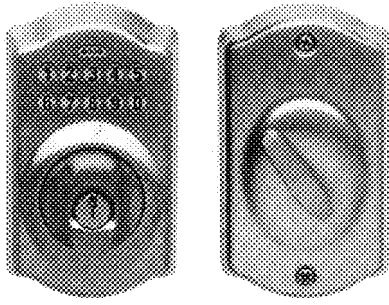

Shown with Camelot escutcheon

Exterior

Interior

SPECIFICATIONS

- DOOR THICKNESS:** 1-3/8" to 1-3/4"
BACKSET: 3AL-Adjustable latch for 2-3/8", 2-3/4" with Square Face/Round Face/Drive-in. SCS.
STRIKE:
BORE: 2-1/8" X 7/8" standard latch
 2-1/8" x 1" drive-in latch
KEY BLANK: 35-100-C
KEYWAYS: C Standard, 5-pin
FINISHES:
- | | |
|--------------------|-----------------------------|
| 505 | ULTIMA™, Bright Brass |
| 609(US-5) | Antique Brass, clear coated |
| 613(US-10B) | Oil Rubbed Bronze* |
| 619(US-15) | Satin Nickel Plated |
| 620(US-15A) | Antique Pewter |
| 625(US-26) | Bright Chrome |
| 626(US-26D) | Satin Chrome |
| 716 | New Aged Bronze |

*613 is a living finish and will wear and change appearance over time

Stock No. Description

- BE365 CAM** with Camelot escutcheon
BE365 PLY with Plymouth escutcheon
 •Specify finish when ordering.

FE SERIES for ELECTONICS

Keypad Front Entry (Bottom Half)

- Residential Lifetime Mechanical Warranty.
- Residential Lifetime Finish Warranty.

FE285 Front Entry (bottom half) Handleset

Combine Schlage's Keypad Deadbolt (shown above) with the FE285 Front Entry to get a complete Handleset with keypad access. All FE285 are stocked with the interior knob/lever. See chart below for availability.

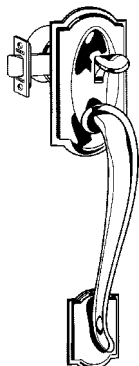

Camelot (CAM)

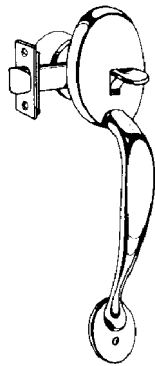

Plymouth (PLY)

Escutcheon

Function	Design	Finish	Inside Design	Hand	***Finish (specify)
FE285	CAM	***	ACC	LH	505,619,620,716
FE285	CAM	***	ACC	RH	505,619,620,716
FE285	CAM	***	GEO		505,609,619,716
FE285	PLY	***	FLA	LH	505,609,613,619,620,625,626,716
FE285	PLY	***	FLA	RH	505,609,613,619,620,625,626,716
FE285	PLY	***	PLY		505,613



Accent(ACC)



Flair(FLA)



Georgian(GEO)

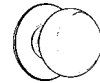

Plymouth(PLY)

©ZIPF LOCK COMPANY

SCHLAGE

FA SERIES

ACCENTS™
Timeless beauty

8 locks per case

For Standard Duty Residential

- ANSI A156.2, 1996, Series 4000, Grade 2.
- Residential Lifetime Mechanical Warranty.
- Residential Lifetime Finish Warranty.
- Field reversible levers (FA10, FA40, FA51).

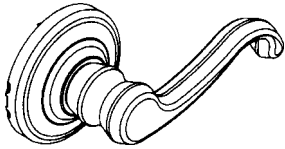

CALLINGTON (CLT)
505, 605, 609, 613,
619, 620, 625, 626, 716
(FA170 Specify Hand)

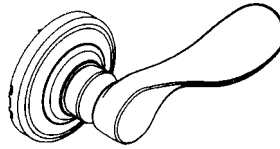

CHAMPAGNE (CHP)
505, 605, 609, 613,
619, 620, 625, 626, 716
(FA170 Specify Hand)

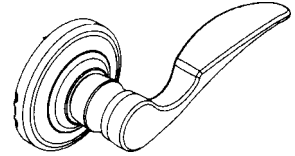

ST ANNES (STA)
505, 605, 609, 613,
619, 620, 625, 626, 716
(FA170 Specify Hand)

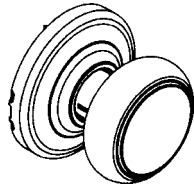

ANDOVER (AND)
505, 605, 609, 613,
619, 620, 625, 626, 716

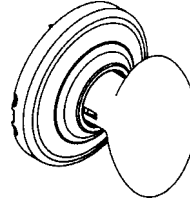

DANBURY (DNB)
505, 605, 609, 613,
619, 620, 625, 626, 716

Function	No.	Operation	ANSI
PASSAGE	FA10	Both knobs/levers are always unlocked.	F75
BATH/BEDROOM PRIVACY	FA40	Push-button locking. Can be opened from outside with small circular tool. Turning inside knob/lever releases button.	F76
ENTRANCE	FA51	Turn button locking. Unlocked by key outside or by turn button inside. Inside lever/knob always unlocked.	F81
SINGLE DUMMY	FA170	Single dummy trim for one side of door. Used for door pull or as matching inactive trim.	

To Order, Specify:

Function: **FA51** Entrance
Design: **CLT** Callington
Finish: **605** Bright Brass
* Handing required on CHP, CLT, STA dummy.

SPECIFICATIONS

DOOR THICKNESS: 1-3/8" to 1-3/4"
BACKSET: 3AL-Adjustable latch for 2-3/8", 2-3/4" with Square Face/Round Face/Drive-in.
STRIKE: Both RCS, SCS.
BORE: 2-1/8" X 7/8" standard latch
2-1/8" x 1" drive-in latch
ROSE: 2-3/4"
KEY BLANK: 35-025-C 5 pin Accents Bow
KEYWAYS: C Standard, 5-pin
FINISHES:
505 ULTIMA™, Bright Brass
605 (US-3) Bright Brass, clear coated
609 (US-5) Antique Brass, clear coated
613 (US-10B) Oil Rubbed Bronze*
619 (US-15) Satin Nickel Plated
620 (US-15A) Antique Pewter
625 (US-26) Bright Chrome
626 (US-26D) Satin Chrome
716 New Aged Bronze

*613 is a living finish and will wear and change appearance over time

BA SERIES

8 locks per case

For Standard Duty Residential

- ANSI A156.5, 2001, Grade 2 auxiliary lock
- Residential Lifetime Mechanical Warranty.
- Residential Lifetime Finish Warranty.
- Door frame strike reinforcer with 3" screws.
- 7/8" wrought brass, reinforced trim ring with security inserts.

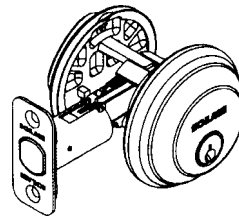

Stock No.	Description
BA360	Single Cylinder
BA362	Double Cylinder

505, 605, 609, 613, 619, 620, 625, 626, 716

TO ORDER, SPECIFY:

Stock No.	Finish (example)
BA360	619

SPECIFICATIONS

DOOR THICKNESS: 1-3/8" to 2"
BACKSET: 3AL-Triple Option Adjustable Latch
STRIKE: Both RCS, SCS.
BORE: 2-1/8" X 7/8" standard latch
2-1/8" x 1" drive-in latch
FINISHES: Same as FA locks.

SCHLAGE

12 locks per case

B600 SERIES



For Heavy Duty Residential & Commercial

- ANSI A156.5, 2001, Grade 1. U.L. Listed, 3-hour.
- 1" Throw Steel Alloy Deadbolt Containing a Hardened Steel Roller to Prevent Cutting.
- Solid Brass or Bronze Rotating Trim Ring.
- Mounting Screws Protected Against Drilling by Steel Balls.
- 3-year Mechanical Warranty.

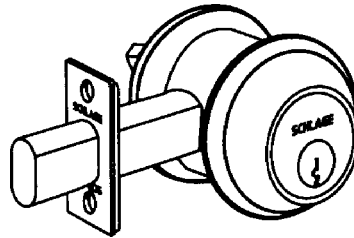

Function	No.	Operation	ANSI
SINGLE CYLINDER	B660P	Deadbolt thrown or retracted by key from outside or by inside turn unit. Bolt automatically deadlocks when fully thrown.	E2151
DOUBLE CYLINDER	B662P*	Deadbolt thrown or retracted by key from either side. Bolt automatically deadlocks when fully thrown.	E2141

SPECIFICATIONS

- DOOR THICKNESS:** 1-5/8" to 2"
BACKSET: 2-3/8", 2-3/4" SCL w/1-1/8" wide face
BORE: 1-1/2" or 2-1/8" x 1"(1-1/16" for Drive-in bolt)
KEY BLANKS: 35-100- 5-pin; 35-101- 6-pin
KEYWAYS: P-C Standard, 6-pin, keyed to 5 pin
 E, F Optional in most cases. **EVEREST-**
 C123 or C145 also available.
J-Less Full Size Interchangeable Core-
 limited selection (626).
BD-Less SFIC- limited selection (626).
FINISHES:
605 (US-3) Bright Brass, clear coated
609 (US-5) Antique Brass, clear coated
613 (US-10B) Oil Rubbed Bronze
619 (US-15) Satin Nickel
626 (US-26D) Satin Chrome

To Order, Specify:

Function: **B660P** Single Cylinder
 Finish: **626** Satin Chrome
 Latch: **234** 2-3/4" Backset

Cylinder Options (Limited Selection-Please Call)

Just replace "P" with...

- | | | |
|--|--|--|
| J- Less Full Size Interchangeable Core. Pictured at right. (626) |  | 23-030-C
23-030-C123
23-030-C145
23-030-E |
| BD-Less SFIC-Small Format I/C (626) | | |

BC100 SERIES



20 locks per case

For Heavy Duty Residential & Commercial

- ANSI A156.5, 2001, Grade 2.
- 1" Throw, With Concealed Hardened Steel Roller.
- 3-year Mechanical Warranty.

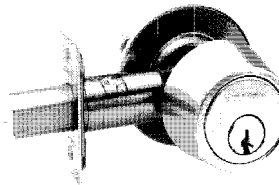

No.	Operation	ANSI
BC160P	SINGLE CYLINDER -Deadbolt thrown or retracted by key from outside or by inside turn unit. Bolt automatically deadlocks when fully thrown. (ANSI E2152)	
BC162P*	DOUBLE CYLINDER -Deadbolt thrown or retracted by key from either side. Bolt automatically deadlocks when fully thrown. (ANSI E2142)	
BC180	DOOR BOLT -Deadbolt thrown or retracted by turn unit only. No outside trim. Bolt automatically deadlocks when fully thrown. (ANSI E2192)	

SPECIFICATIONS

- DOOR THICKNESS:** 1-3/8" to 1-3/4"
BACKSET: AL-Adjustable for 2-3/8" or 2-3/4" Sq. Corner. Some locks may be available with the 3AL-Adjustable latch for 2-3/8", 2-3/4" with Square Face/Round Face/Drive-in.
BORE: 1-1/2" or 2-1/8" x 1"
KEY BLANKS: 35-100- 5-pin; 35-101- 6-pin
KEYWAYS: P-C Standard, 6-pin, keyed to 5 pin
 E, F Optional in most cases. **EVEREST-**
 C123 also available.
J-Less Full Size Interchangeable Core-
 limited selection (626).
BD-Less SFIC- limited selection (626).
L-Less cylinder- limited selection (626)
FINISHES:
605 (US-3) Bright Brass, clear coated
609 (US-5) Antique Brass, clear coated
612 (US-10) Satin Bronze, clear coated
613 (US-10B) Oil Rubbed Bronze
625 (US-26) Bright Chrome
626 (US-26D) Satin Chrome

To Order, Specify:

Function: **BC160P** Single Cylinder
 Finish: **626** Satin Chrome
 Latch: **AL** Adjustable Backset

Cylinder Options (Limited Selection-Please Call)

Just replace "P" with...

- | | | |
|--|---|--|
| J- Less Full Size Interchangeable Core. Pictured at right. (626) |  | 23-030-C
23-030-C123
23-030-C145
23-030-E |
| BD-Less SFIC-Small Format I/C (626) | | |
| L- Less cylinder (BC160L 626 only) | | |

***Caution:** Double cylinder locks on residences and any door in any structure which is used for egress are a life safety hazard in times of emergency and their use is not recommended. Installation should be in accordance with existing codes only.

181_{v1}
(PL-10)

©ZIPF LOCK COMPANY

SCHLAGE

20 locks per case

B200 SERIES NIGHTLATCH



For Residential & Commercial

- ANSI A156.5, 2001, Grade 2
- 9/16" Throw Deadlatch That Prevents "shimming" The Bolt With a Credit Card or Similar Tool.
- Trim Rings are Reinforced With Hardened Steel Inserts.
- A "hold-back" Feature Retains the Deadlatch in a Retracted Position When Desired.
- 3-year Mechanical Warranty.

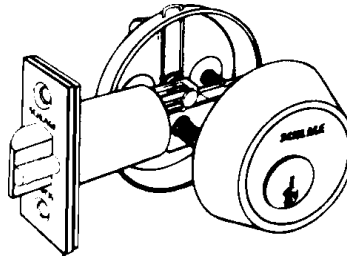

Function	No.	Operation	ANSI
NIGHT LATCH	B250PD	Deadlocking latchbolt retracted by key from outside or by inside turn unit. Rotating turn unit and activating hold-back feature keeps latch retracted.	E2122
DBL. CYLINDER DEADLATCH	B252PD*	Deadlocking latchbolt retracted by key from either side. No holdback feature.	E2112

To Order, Specify:

Function: **B250PD** *Single Cylinder*
 Finish: **626** *Satin Chrome*
 Latch: **234** *2-3/4" Backset*

SPECIFICATIONS

DOOR THICKNESS: 1-3/8" to 1-3/4"
BACKSET: 2-3/8" or 2-3/4"
BORE: 1-1/2"
BOLT THROW: 9/16"
KEY BLANK: 35-100-C 5-pin
KEYWAYS: C Standard, 5-pin
FINISHES: **605** (US-3) Bright Brass, clear coated
626 (US-26D) Satin Chrome

BR200 SERIES



20 locks per case

For Residential & Commercial

- ANSI A156.5, 1992, Grade 2
- 1" Bolt Throw with Concealed Hardened Steel Roller to Resist Cutting or Sawing the Latchbolt.
- Reinforced Trim Ring Rotates to Protect Against Wrenching the Cylinder.
- Residential Lifetime Mechanical Warranty.
- Residential 10-year Finish Warranty.
- Residential 505-Ultima™ Lifetime Finish.

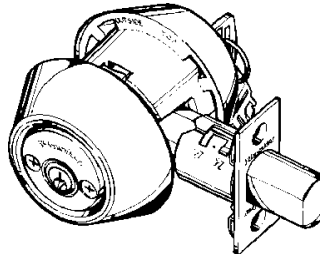

Limited supply -
Discontinued by factory.

Function	No.	Operation	ANSI
SINGLE CYLINDER	BR260	Deadbolt thrown or retracted by key from outside or by inside turn unit. Bolt automatically deadlocks when fully thrown.	E2152
DOUBLE CYLINDER	BR262*	Deadbolt thrown or retracted by key from either side. Bolt automatically deadlocks when fully thrown.	E2142

SPECIFICATIONS

DOOR THICKNESS: 1-3/8" to 1-3/4"
BACKSET: 3AL-Adjustable latch for 2-3/8", 2-3/4" with Square Face/Round Face/Drive-in.
BORE: 2-1/8" x 1"
KEY BLANK : 35-100-C 5 pin
KEYWAYS: C Standard, 5-pin
FINISHES: **505** Bright Brass, ULTIMA™-Lifetime
605 (US-3) Bright Brass, clear coated
609 (US-5) Antique Brass, clear coated
625 (US-26) Bright Chrome
626 (US-26D) Satin Chrome

To Order, Specify:

Function: **BR260** *Single Cylinder*
 Finish: **605** *Bright Brass*
 Latch: **3AL** *Triple Option Latch*

SCHLAGE

See pages 178 for ACCENTS Series, page 177 for electronic deadbolt

B300 SERIES



20 locks per case

For Heavy Duty Residential/Light Duty Commercial

- ANSI A156.5, 2001, Grade 2.
- 1" Throw Deadbolt with Concealed Hardened Steel Roller to Prevent Cutting or Sawing the Bolt.
- Concealed Spin Ring Rotates to Protect Against Wrenching the Cylinder.
- Solid Brass 5-pin Cylinder. Pick Resistant Spool Pins.
- Solid Steel Door Frame Reinforcer with 3" Screws Protects Against Kick-in Attack.
- Residential Lifetime Mechanical Warranty.
- Residential 10-year Finish Warranty (605/609/626).
- Residential 505-Ultima™ Lifetime Finish.
- Residential Artisan Lifetime Finish(613/619/620/625).

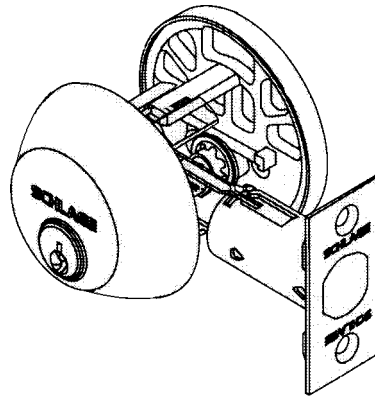

Function	No.	Operation	ANSI
SINGLE CYLINDER	B360N	Deadbolt thrown or retracted by key from outside or by inside turn unit. Bolt automatically deadlocks when fully thrown.	E2152
DOUBLE CYLINDER	B362N*	Deadbolt thrown or retracted by key from either side. Bolt automatically deadlocks when fully thrown.	E2142

To Order, Specify:

Function: **B360N** *Single Cylinder*
 Finish: **619** *Satin Nickel Plated*
 Latch: **3AL** *Triple Option Latch*

SPECIFICATIONS

DOOR THICKNESS: 1-3/8" to 1-3/4"
BACKSET: Adjustable 2-3/8" to 2-3/4" with square, round corner and Drive-in faces
BORE: 1-1/2" or 2-1/8" x 1"
KEY BLANK: 35-100-C 5-pin
KEYWAYS: C Standard, 5-pin
FINISHES:
505 Bright Brass, ULTIMA™-Lifetime
605 (US-3) Bright Brass, clear coated
609 (US-5) Antique Brass, clear coated
613 (US-10B) Oil Rubbed Bronze-Artisan Lifetime
619 (US-15) Satin Nickel Plated-Artisan Lifetime
620 (US-15A) Antique Pewter-Artisan Lifetime
625 (US-26) Bright Chrome-Artisan Lifetime
626 (US-26D) Satin Chrome
716 New Aged Bronze

*613 is a living finish and will wear and change appearance over time

FB300 SERIES

6 sets per case

Maximum Security Combo Pack

- Keyed Alike for Double Security.
- Same Key Operates Both Deadbolt and Keyed Entry Lock.

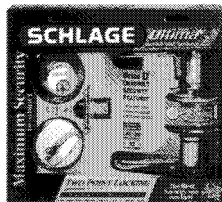

No.	Operation
FB350NV	SINGLE CYLINDER -Keyed alike entry lock (F51) and 1" throw deadbolt (B360N). Furnished with 4 keys.

To Order, Specify:

Function: **FB350NV** *Combo Pack*
 Design: **ACC *Accent*
 Finish: **505** *Bright Brass, Ultima™ Lifetime*
 Latch: **3AL** *Triple Option Latch*
 ***Handing: **RH** *Right Hand*

*Available in the following Designs:
ACC 505; BEL 505; FLA 505; GEO 505, 609; PLY 505.
 *****HANDING** required on Accent and Flair (RH or LH).

TRIPLE OPTION LATCH-

With the Triple Option Latch you have 6 latches in 1. Adjustable for 2-3/8" and 2-3/4" backsets. You can snap on the face that you need: square corner, round corner or drive-in. **Also 2 strikes:** 1 square and 1 round corner. Now you can be ready for any door.

This latch is available on BR200 Series, B300 Series, FB350 Series, FB Handles and most F locks we stock. Just specify latch (**3AL**) when ordering locks.

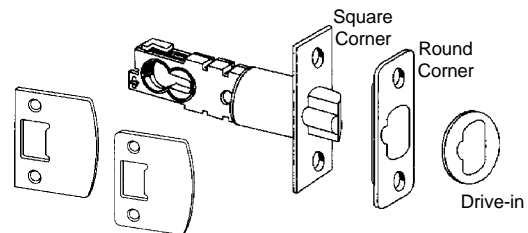

***Caution:** Double cylinder locks on residences and any door in any structure which is used for egress are a life safety hazard in times of emergency and their use is not recommended. Installation should be in accordance with existing codes only.

SIMPLEX



SIMPLEX 6200 SERIES LIGHT COMMERCIAL/ RESIDENTIAL LOCK

- 3-hour UL.ULC fire rating for "A" label doors
- Vandal resistant, 5 button
- Retrofits 2-1/8" standard bore cylindrical locksets

SPECIFICATIONS

Lock Body: Height 8-7/8" x Width 2-3/4" x Depth 2-9/16"
Backset: 2-3/4"
Throw: 1/2"
Bore: 2-1/8"
Strike: T-strike with strike box
Door Thick.: 1-3/8" to 2-1/4"
Minimum Stile: 5"
Handing: Factory handed left, field reversible

Access by combination, while allowing free egress at all times by interior knob. The lockset automatically relocks each time the door closes. The lock can be inverted if the existing auxiliary lock obstructs installation.

Combination Code: One code per lock made of any combination of one to five numbers (pressed individually or simultaneously). **Number of Combinations:** Thousands of possible combinations.

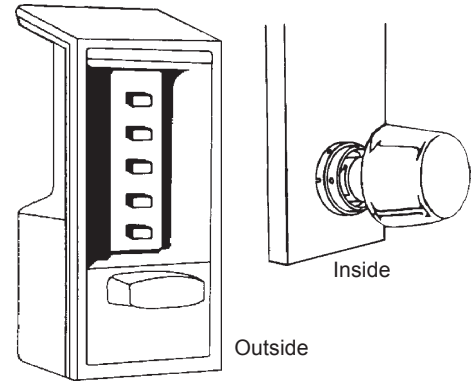

<u>Stock No.</u>	<u>Finish</u>
SI-6204-60-41	Gold Tone
SI-6204-85-41	Black
SI-6204-86-41	Grey

SIMPLEX 7100 SERIES LIGHT COMMERCIAL/ RESIDENTIAL LOCK

- Vandal resistant, 5 button

SPECIFICATIONS

Lock Body: Height 8-7/8" x Width 2-3/4" x Depth 2-9/16"
Backset: varies by model number
Throw: varies by model number
Bore: 1-3/8" x 1" (except 7106: 3/4")
Strike: **7102, 7108:** Flat strike
7104: curved lip strike
7106: box strike for inswing door, flat or outswing doors
Door Thick.: 1-3/8" to 2-1/4"
Minimum Stile: 4"
Handing: Field reversible

The 7100 Series lockset provides fully mechanical primary or auxiliary push-button access control by exterior combination, while allowing free egress at all times by interior thumbturn. Deadbolt models are manually relocking. Deadlocking models automatically relock each time the door closes. 7100 Series locks mount above the existing lockset, or can be used alone.

Combination Code: One code per lock made of any combination of one to five numbers (pressed individually or simultaneously). **Number of Combinations:** Thousands of possible combinations.

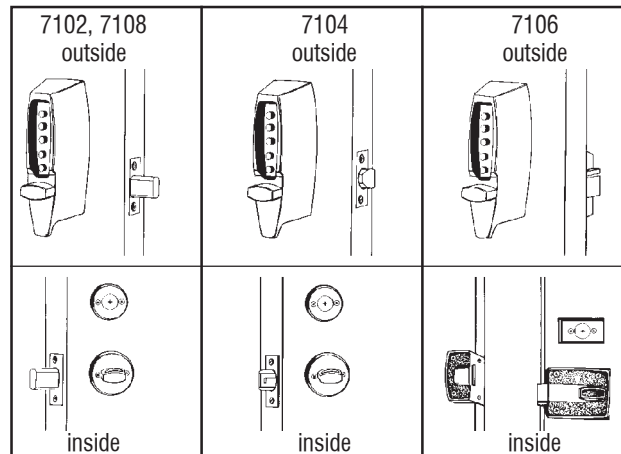

<u>Stock No.</u>	<u>Finish</u>
• 1" deadbolt, 2-3/4" backset, Manual relock.	
SI-7102-03-41	Bright Brass
SI-7102-26D-41	Satin Chrome
• 1" deadbolt, 2-3/8" backset, Manual relock.	
SI-7108-03-41	Bright Brass
• 1/2" deadlocking latch, 2-3/8" - 2-3/4", Auto relock.	
SI-7104-03-41	Bright Brass
SI-7104-26D-41	Satin Chrome
• 5/8" deadlocking latch (surface), 2-3/8" backset, Auto relock & latch holdback. For wood doors only.	
SI-7106-19-41	Black (Powder Paint)
SI-7106-26D-41	Satin Chrome

We are your source for Simplex

The 7000 Series is changing to the 7100 Series.

©ZIPF LOCK COMPANY

WEISER

6 locks per case

KEYLESS HOME ACCESS SYSTEM

Powerbolt Deadbolts

- 1" projection deadbolt latch with 1/4" diameter hardened steel free-turning roller.
- Easy to Install, Easy to Program, Easy to Use.
- Requires 4 "AA" alkaline batteries (not included).
- Residential 1-Year Electrical components warranty.
- Residential Lifetime Mechanical warranty.
- Residential Lifetime Finish warranty.

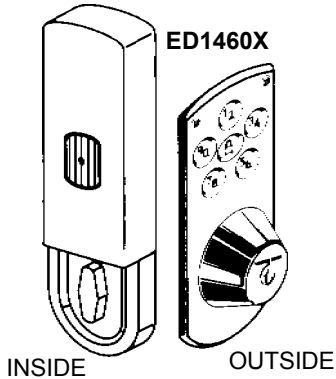

WEISER LOCK™

Powerbolt

SPECIFICATIONS

DOOR THICKNESS:	1-3/8" to 2"
BACKSET:	Adjustable 2-3/8" to 2-3/4"
BORE:	2-1/8" x 1"
BOLT THROW:	1"
FINISHES:	US-3^B Bright Brass US-15 Satin Nickel US-26D^B Satin Chrome

^BBrilliance Finish is standard on exterior side of locks.-

Other finishes available by special order.

HOW TO ORDER: Specify,

Function: **ED1460X** Single Cylinder
Finish: **US-3** Bright Brass
Latch: **AL** Adjustable

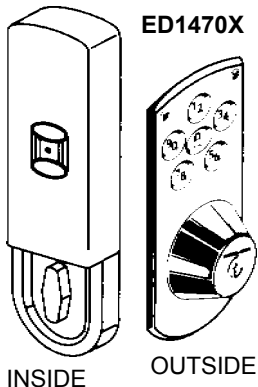

Stock No.
ED1460X

Operation

Single Cylinder Deadbolt-Deadbolt latch retracted by entering security code outside and extended by pushing lock button outside. Deadbolt latch extended and retracted by T-Turn on inside. Using key outside will retract deadbolt latch if needed.

ED1470X

Same as above except includes push button lock and unlock buttons on inside to extend or retract deadbolt.

Electronic Keyless Entry System

- Simply enter your personalized access code for convenient, quick and carefree entry.
- You may also program a temporary second code for a neighbor, cleaning crew, etc.
- Alarm sounds after 3 consecutive incorrect codes are entered.
- Easy-one touch locking.
- Heavy duty security deadbolt and strike plate resist break-ins.
- No wiring necessary (add 4 Alkaline "AA" batteries).
- Low battery indicator.
- Fits standard preparation on new doors.
- Easily replaces existing door hardware.

We also stock Kwikset's 907 Series Powerbolt.

©ZIPF LOCK COMPANY

230 v1
(PL-14)

WEISER

WELCOME HOME SERIES DEADBOLTS

Heavy Duty Deadbolts

- ANSI A156.5, Grade 2 on wooden frames.
- 1" projection deadbolt latch with 1/4" diameter hardened steel free-turning roller.
- Single cylinder T-turn meets handicapped specifications.
- Residential Lifetime Mechanical warranty.
- Residential Lifetime Finish warranty.



D9470X: 24 locks per case.
D9370X: 12 locks per case.

Welcome Home SERIES®

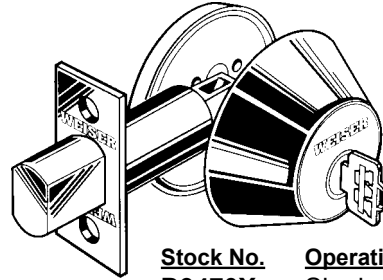

Stock No.	Operation
D9470X	Single Cylinder
D9370X	Double Cylinder

HOW TO ORDER: Specify,

Function: **D9470X** Single Cylinder
 Finish: **US-3** Bright Brass
 *Latch: **AL** Adjustable

*Weiser Lock will be switching over to 6AL Universal latch. This latch includes drive-in latch with square corner and round corner faceplates. Most locks will be switching to round corner strikes (RCS-R2).

SPECIFICATIONS

DOOR THICKNESS:	1-3/8" to 1-3/4"
BACKSET:	Adjustable 2-3/8" to 2-3/4"
BORE:	1-1/2" x 1"
	2-1/8" x 1" acceptable if grade 2 not required.
BOLT THROW:	1"
STRIKE:	10046-1
FINISHES:	US-3^B Bright Brass
	US-5 Antique Brass, oxidized, hand relieved and highlighted
	US-11P Venetian Bronze™
	US-12 Tuscan Copper™
	US-15 Satin Nickel
	US-26D^B Satin Chrome

^BBrilliance Finish is standard on exterior side of locks.

ELEMENTS SERIES DEADBOLTS

Standard Duty Deadbolts

- 1" projection deadbolt latch with 1/4" diameter hardened steel free-turning roller.
- Single cylinder T-turn meets handicapped specifications.
- Residential 25-Year Mechanical Warranty.
- Residential 10-Year Finish Warranty.



DC9470L: 24 locks per case.
DC9370L: 12 locks per case.

elements SERIES™

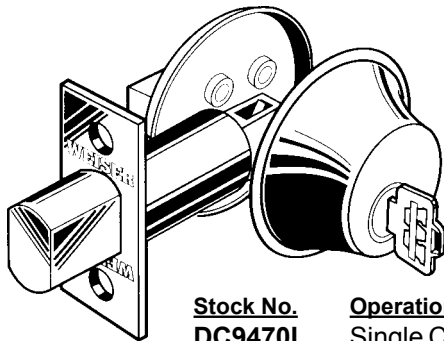

Stock No.	Operation
DC9470L	Single Cylinder
DC9370L	Double Cylinder

SPECIFICATIONS

DOOR THICKNESS:	1-3/8" to 1-3/4"
BACKSET:	Adjustable 2-3/8" to 2-3/4"
BORE:	1-1/2" x 1"
BOLT THROW:	1"
STRIKE:	5051
FINISHES:	US-3 Bright Brass
	US-5 Antique Brass, oxidized, hand relieved and highlighted
	US-15 Satin Nickel
	US-26D Satin Chrome

HOW TO ORDER: Specify,

Function: **DC9470L** Single Cylinder
 Finish: **US-3** Bright Brass
 *Latch: **AL** Adjustable

*Weiser Lock will be switching over to 6AL Universal latch. This latch includes drive-in latch with square corner and round corner faceplates. Most locks will be switching to round corner strikes (RCS-R3).

©ZIPF LOCK COMPANY

WEISER

D SERIES GATELOCK

Gate Lock with Deadlocking Latch

- Residential Lifetime Mechanical warranty.
- Residential Lifetime Finish warranty.

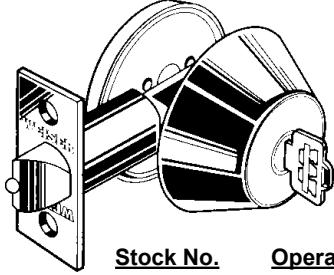

Stock No.
D840X

Operation
Single Cylinder

WEISER LOCK™

24 locks per case

SPECIFICATIONS

DOOR THICKNESS: 1-1/2" to 1-7/8"
BACKSET: Adjustable 2-3/8" to 2-3/4"
BORE: 2-1/8" x 1"
BOLT THROW: 1/2"
FINISHES: **US-3** Bright Brass

HOW TO ORDER: Specify,

Function: **D840X** Single Cylinder
 Finish: **US-3** Bright Brass
 Latch: **AL** Adjustable

INDICATOR DEADBOLT

The Indicator Deadbolt has a thumbturn on the inside and displays "VACANT" on a green panel when open and "OCCUPIED" on a red panel when locked.

- Lifetime Mechanical warranty.

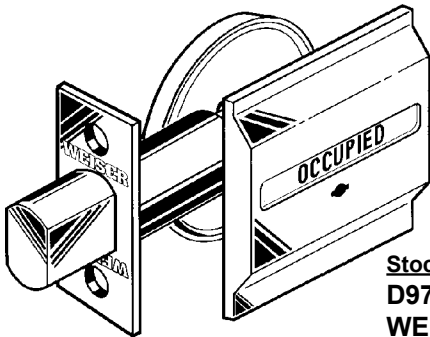

Stock No.
D9770I
WE-9159

Operation
Indicator Deadbolt
Emergency Key

Welcome Home SERIES®

24 locks per case

SPECIFICATIONS

DOOR THICKNESS: 1-3/8" to 1-3/4"
BACKSET: Adjustable 2-3/8" to 2-3/4"
BORE: 1-1/2" x 1"
BOLT THROW: 1"
FINISHES: **US-3** Bright Brass
US-26D Satin Chrome

HOW TO ORDER: Specify,

Function: **D9770I** Indicator Deadbolt
 Finish: **US-3** Bright Brass
 Latch: **AL** Adjustable



CONNECTING DOOR DEADBOLT

The Connecting Door deadbolt has a blank plate on the exterior of door. Deadbolt operated by thumbturn on interior of door.

- Residential Lifetime Mechanical warranty.

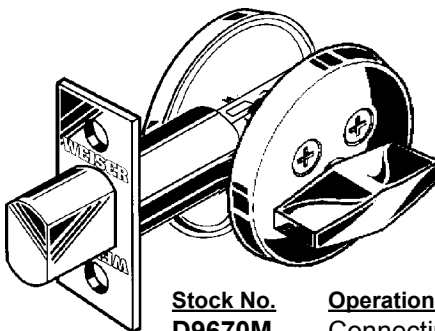

Stock No.
D9670M

Operation
Connecting Door Deadbolt

*Discontinued. Call
for closeout prices.*

Welcome Home SERIES®

24 locks per case

SPECIFICATIONS

DOOR THICKNESS: 1-3/8" to 1-3/4"
BACKSET: Adjustable 2-3/8" to 2-3/4"
BORE: 1-1/2" x 1"
BOLT THROW: 1"
FINISHES: **US-3** Bright Brass
US-26D Satin Chrome

HOW TO ORDER: Specify,

Function: **D9670M** Connecting Door
 Finish: **US-3** Bright Brass
 Latch: **AL** Adjustable