

# ALARM LOCK

## T2 SERIES DIGITAL LOCKS

- ANSI/BHMA A156.2, Series 4000, UL Listed Grade 1



- **STRENGTH**
- **RELIABILITY**
- **INTEGRITY**

Alarm Lock 2700 Series Trilogy

**NOTE:** The DL2700 Series can not be used on exterior applications unless you order the **WP**.

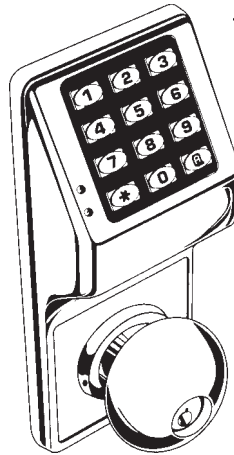

**AK-DL2750**  
US-26D

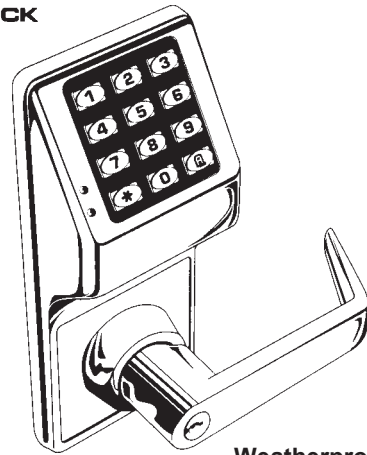

**AK-DL2700**  
US-3, 5, 26D

**Weatherproof**  
**AK-DL2700WP**  
26D

**Features:**

**Keypad:** Vandal-Resistant 12-button metal  
**Operation:** Rugged clutch  
**Handing:** Non-handed  
**User Codes:** 17  
**Code Length/No. of Codes:** 3-5 digit codes; 29,000,000 codes  
**User Levels:** Master, Manager, User, 1X Service  
**Special Functions:** Passage, Individual, Group, Total Lockout  
**Programming:** Keypad  
**Audit Trail Events:** n/a  
**Scheduled Events:** n/a  
**Remote Release Option:** Yes, by special order.  
**Relay Control:** Yes, for example an external siren or CCTV can be triggered

**Power:** 5 AA batteries, Supplied  
**Typical Cycles/Battery Indication:** 100,000; visual & audible low-batt. indicator  
**Weather-Resistant Models:** Order AK-DL2700WP model  
 Operating Range of Above WP's: WP's: -20° to +151°F  
**Proximity Card Support:** n/a  
**Finishes:** US3, 5, 26D  
**Trim:** Standard squared lever  
**Door Thickness:** 1-5/8" to 1-7/8"  
**Backset:** 2-3/4"  
**Latchbolt:** UL, 3 Hour, Fired-rated 1/2" throw solid brass  
**Strikes:** 1-1/8" x 2-3/4" T strike & 1-1/4" x 4-7/8" ASA  
**Cylinder:** 6-pin solid brass, SC1 keyway

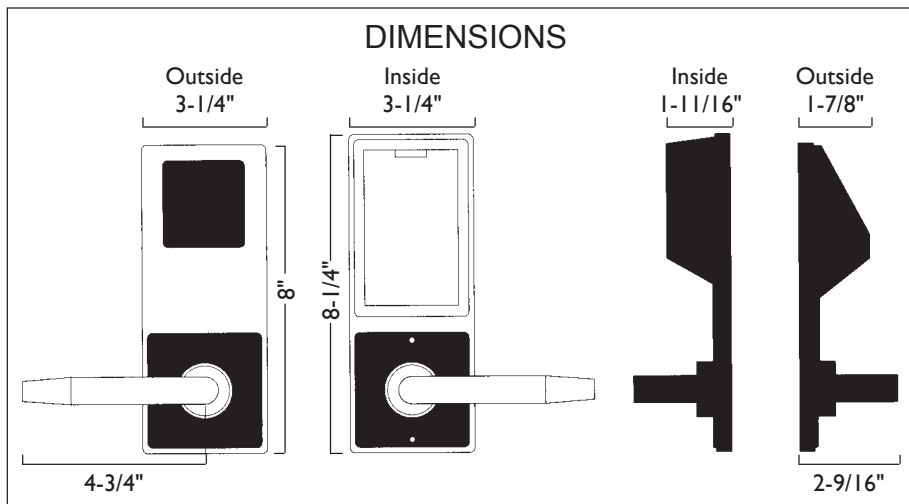

©ZIPF LOCK COMPANY

Continued on next page

# ALARM LOCK

## T2 SERIES DIGITAL LOCKS

- Continued from previous page.



ALARM LOCK



### FEATURES:

- Clutch mechanism offers exceptional reliability and strength.
- Super heavy-duty trim design with self-contained, fully programmable 12 digit metal keypad.
- Battery powered, uses five AA batteries for long-life dependability & audible low power alert.
- Non-handed for easy installation and versatility, retrofit or new.
- 2-wire remote override or key bypass capability.
- Visual and audible entry indicators.
- Available in lever or knob design with rekeyable cylinder (interchangeable core version-special factory order).
- UL Listed Grade One lockset with fire rated latch meets or exceeds BHMA specifications.
- Choose from polished brass, antique brass or satin chrome. (Polished chrome-special factory order)

### 12 KEY PROGRAMMABLE ACCESS CODES

- Multi-level user capability.
- Master code.
- Manager code.
- Passage function.
- One time emergency or service entrance code-erases from memory after use.
- Timed entry allowance from 5 to 20 seconds.
- Up to 15 different group or individual codes.
- Individual, group or total user lockout code.
- Master and management can temporarily or permanently change any or all user codes.
- Temporarily shuts down if incorrect code is entered three times consecutively..

## INSTALLATION KITS

By ProLok

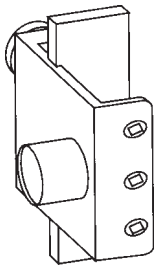

### PK-INCL

#### Universal Clamp

The cornerstone of our Professional Installation Series. Holds all of the specialty templates without damage to the door's finish. Complete with an easy to use 1-1/2" sure-grip knob for quick and positive hand tightening. For 1-3/4" door with a 2-3/4" backset.

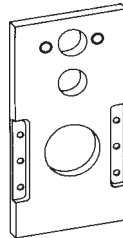

### PK-IN10

#### Simplex/Trilogy

Preps door for Simplex 1000 Series locks and Trilogy push button locks.

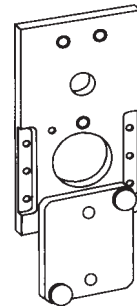

### PK-IN15

Alarm Lock Trilogy T-2 Preps door for OLD Style Trilogy T-2 Series locks.

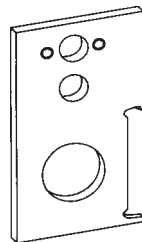

### PK-IN10R

#### Reverse Simplex/Trilogy

Same as IN10 but preps reverse side of door.

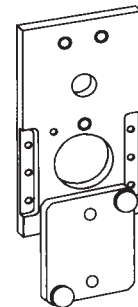

### PK-IN15A

#### Alarm Lock Trilogy T-2, T-3

Preps door for NEW STYLE Trilogy T-2, T-3 all cylindrical locks.

# KWIKSET

## TOUCHPAD ELECTRONIC DEADBOLT

### Powerbolt Deadbolts

- 1" projection deadbolt latch with 1/4" diameter hardened steel free-turning roller.
- Easy to Install, Easy to Program, Easy to Use.
- Requires 4 "AA" alkaline batteries (not included).
- Residential 1-Year Electrical components warranty.
- Residential Lifetime Mechanical warranty.
- Residential 5-year Finish warranty.
- Residential Lifetime Finish warranty on LO3.

### Electronic Keyless Entry System

- Simply enter your personalized access code for convenient, quick and care-free entry.
- You may also program a temporary second code for a neighbor, cleaning crew, etc.
- Alarm sounds after 3 consecutive incorrect codes are entered.
- Easy-one touch locking.
- Heavy duty security deadbolt and strike plate resist break-ins.
- No wiring necessary (add 4 Alkaline "AA" batteries).
- Low battery indicator.
- Fits standard preparation on new doors.
- Easily replaces existing door hardware.

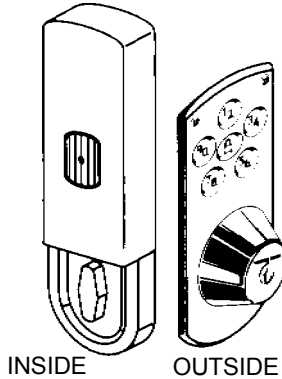

### SPECIFICATIONS

**DOOR THICKNESS:** 1-3/8" to 2"  
**BACKSET:** Adjustable 2-3/8" to 2-3/4"  
**BORE:** 2-1/8" x 1"  
**BOLT THROW:** 1"  
**FINISHES:** **US-LO3** Bright Brass - Lifetime  
**US-11P** Venetian Bronze  
**US-15** Satin Nickel

### HOW TO ORDER: Specify,

**Function:** **907** Single Cylinder  
**Finish:** **US-LO3** Bright Brass  
**Latch:** **AL** Adjustable

### Stock No. Operation

**907 Single Cylinder Deadbolt-**  
 Deadbolt latch retracted by entering security code outside and extended by pushing lock button outside. Deadbolt latch extended and retracted by T-Turn on inside. Using key outside will retract deadbolt latch if needed.

## 970 SERIES DEADBOLTS

- ANSI A156.5, Grade 2.
- Full 1" Nickel Plated Steel Bolt.
- Solid Steel Strike.
- 5-pin cylinder.
- Lifetime Mechanical Warranty.
- 5-year Finish Warranty.
- Lifetime Finish Warranty on LO3 Finish.

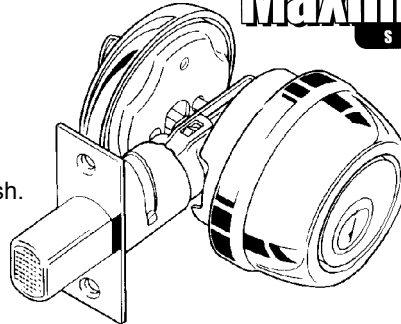

12 locks per case.



Interior turnpiece meets 4.13.9 ADA requirements

### 970 Single Cylinder

US-L03, 3, 5, 11P, 15, 15A, 26, 26D

### 975 Double Cylinder

US-L03, 3, 5, 11P, 15, 15A, 26, 26D

**DOOR THICKNESS:** 1-3/8" to 1-3/4"  
**BACKSET:** Adjustable for 2-3/8", 2-3/4"  
**BORE:** 2-1/8" or 1-1/2" x 1"  
**CYLINDER:** 5-pin  
**KEY BLANK:** KW-81063  
**FINISHES:** **US-LO3** (605E) Polished Brass-Lifetime  
**US-3** (605) Polished Brass  
**US-5** (609) Antique Brass  
**US-11P** Venetian Bronze  
**US-15** (619) Satin Nickel  
**US-15A** (620) Antique Nickel  
**US-26** (625) Polished Chrome  
**US-26D** (626) Satin Chrome

### No. Description

**970 Single Cylinder:** Deadbolt operated by key outside or thumbturn inside.  
**975 Double Cylinder:** Deadbolt operated by key both sides.

### To Order, Specify:

**Function:** **975** Double Cylinder  
**Finish:** **US-3** Polished Brass  
**\*Latch:** **AL** Adjustable

\*2-3/8" or 2-3/4" adjustable deadbolt latch is standard.  
 Specify **RCAL** for Round Corner Adjustable Latch.  
 Specify **SCAL** for Square Corner Adjustable Latch.  
 Specify **RFAL** for Round Face Adjustable Latch.

# SCHLAGE

6 locks per case

## FE SERIES ELECTRONICS



### Keypad Entry Locks

- ANSI A156.2-2003 bored locks and latches.
- ANSI A156.5-2001 Grade 2 cylinders.
- Residential Lifetime Mechanical Warranty.
- Residential Lifetime Finish Warranty.
- FCC Part 15, CE Mark.

#### FE575 Auto-Lock

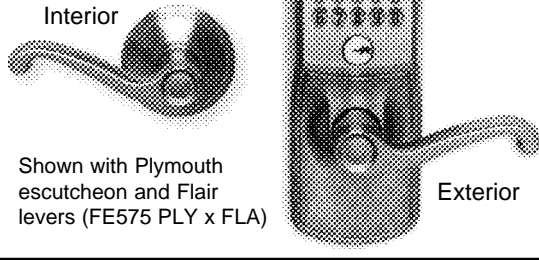

#### FE595 Flex-Lock

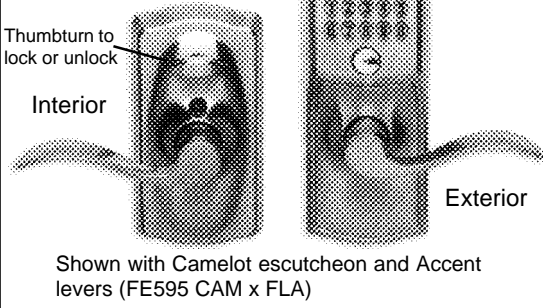

#### FE575 Auto-Lock Feature

Schlage Keypad locks with the Auto-Lock feature automatically re-lock five seconds after use, providing complete confidence and protection for your family and valuables. Ideal for use on doors leading to basement stairways, storage and utility rooms, workshops and more.

#### FE595 Flex-Lock Feature

Schlage Keypad locks with the Flex-Lock feature allow homeowners to choose whether their door remains locked (with a code required for entry) or unlocked (no code required for entry) simply by rotating the inside thumbturn. This added layer of protection ensures that valuables and family members are safe, and ideal for garage entry doors, home offices, storage rooms and more.

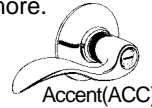

Function	Design	Finish	Inside Design	Image
FE575	CAM	***	ACC	Flair(FLA)
FE575	PLY	626	ELA	
FE575	PLY	***	FLA	
FE575	PLY	626	JAZ	Georgian(GEO)
FE575	PLY	505	PLY	
FE595	CAM	***	ACC	Jazz(JAZ)
FE595	CAM	505	GEO	
FE595	CAM	609	GEO	
FE595	CAM	619	GEO	
FE595	PLY	626	ELA	
FE595	PLY	***	FLA	
FE595	PLY	626	JAZ	Plymouth(PLY)

\*\*\*Specify Finish: 505,609,613,619,620,625,626,716

**Example—  
FE595 CAM 620 ACC**

### SPECIFICATIONS

<b>DOOR THICKNESS:</b>	1-3/8" to 1-3/4"
<b>BACKSET:</b>	3AL-Adjustable latch for 2-3/8", 2-3/4" with Square Face/Round Face/Drive-in. Both RCS, SCS.
<b>STRIKE:</b>	2-1/8" X 7/8" standard latch
<b>BORE:</b>	2-1/8" x 1" drive-in latch
<b>KEY BLANK:</b>	35-100-C
<b>KEYWAYS:</b>	C Standard, 5-pin
<b>FINISHES:</b>	<b>505</b> ULTIMA™, Bright Brass <b>609(US-5)</b> Antique Brass, clear coated <b>613(US-10B)</b> Oil Rubbed Bronze* <b>619(US-15)</b> Satin Nickel Plated <b>620(US-15A)</b> Antique Pewter <b>625(US-26)</b> Bright Chrome <b>626(US-26D)</b> Satin Chrome <b>716</b> New Aged Bronze

\*613 is a living finish and will wear and change appearance over time

### Security and Quality

- Grade 2 ANSI/BHMA certified
- Patented commercial grade clutching motor drive: tested to one million cycles.
- Vandal resistant clutching lever and knob design.
- Code control, 6-digit programming code required to add and delete user codes.
- Warning code sounds after 4 incorrect codes entered; keypad disabled for 30 seconds.
- Mechanical key override: patent pending.

### Convenience

- Convenient keyless access; no keys to hide, lose or forget.
- Pre-set with random 6-digit programming code and two random 4-digit user codes.
- 19 user code capacity; 10,000 user code combinations.
- Easily programmed right at the keypad; no need to remove inside escutcheon.
- Blue LEDs illuminate the keypad on demand.
- Reversible levers for left- or right-handed doors.
- Emergency exit feature; allows for panic-free exit.
- Locks can be rekeyed to match existing locks.
- 9-volt alkaline battery included.

©ZIPF LOCK COMPANY

# SCHLAGE

6 locks per case

## BE SERIES ELECTRONICS

### Keypad Deadbolts

- Grade 2 ANSI/BHMA certified.
- ANSI A156.5-2001 Grade 2 auxiliary locks.
- Residential Lifetime Mechanical Warranty.
- Residential Lifetime Finish Warranty.
- FCC Part 15, CE Mark.



### BE365 with Turn-Lock Feature

Schlage Keypad Deadbolts bring professional grade security with the convenience of keyless access to the home. The innovative Turn-Lock feature allows the user to lock and leave without a key. Ideal for front, back and side entry doors where deadbolts are required.

### Security and Quality

- Grade 2 ANSI/BHMA certified
- Patented commercial grade clutching motor drive: tested to one million cycles.
- Vandal resistant free spinning deadbolt turn.
- Code control, 6-digit programming code required to add and delete user codes.
- Warning code sounds after 4 incorrect codes entered; keypad disabled for 30 seconds.
- Mechanical key override: patent pending.

### Convenience

- Convenient keyless access; no keys to hide, lose or forget.
- Pre-set with random 6-digit programming code and two random 4-digit user codes.
- 19 user code capacity; 10,000 user code combinations.
- Easily programmed right at the keypad; no need to remove inside escutcheon.
- Blue LEDs illuminate the keypad on demand.
- Locks can be rekeyed to match existing locks.
- 9-volt alkaline battery included.

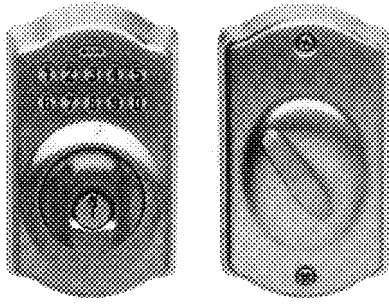

Shown with Camelot escutcheon

Exterior

Interior

### SPECIFICATIONS

- DOOR THICKNESS:** 1-3/8" to 1-3/4"  
**BACKSET:** 3AL-Adjustable latch for 2-3/8", 2-3/4" with Square Face/Round Face/Drive-in. SCS.  
**STRIKE:**  
**BORE:** 2-1/8" X 7/8" standard latch  
 2-1/8" x 1" drive-in latch  
**KEY BLANK:** 35-100-C  
**KEYWAYS:** C Standard, 5-pin  
**FINISHES:**
- |                    |                             |
|--------------------|-----------------------------|
| <b>505</b>         | ULTIMA™, Bright Brass       |
| <b>609(US-5)</b>   | Antique Brass, clear coated |
| <b>613(US-10B)</b> | Oil Rubbed Bronze*          |
| <b>619(US-15)</b>  | Satin Nickel Plated         |
| <b>620(US-15A)</b> | Antique Pewter              |
| <b>625(US-26)</b>  | Bright Chrome               |
| <b>626(US-26D)</b> | Satin Chrome                |
| <b>716</b>         | New Aged Bronze             |

\*613 is a living finish and will wear and change appearance over time

### Stock No. Description

- BE365 CAM** with Camelot escutcheon  
**BE365 PLY** with Plymouth escutcheon  
**•Specify finish when ordering.**

## FE SERIES for ELECTONICS

### Keypad Front Entry (Bottom Half)

- Residential Lifetime Mechanical Warranty.
- Residential Lifetime Finish Warranty.

### FE285 Front Entry (bottom half) Handleset

Combine Schlage's Keypad Deadbolt (shown above) with the FE285 Front Entry to get a complete Handleset with keypad access. All FE285 are stocked with the interior knob/lever. See chart below for availability.



Camelot (CAM)

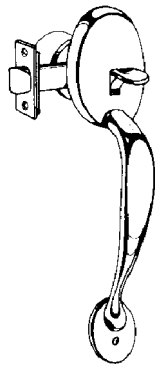

Plymouth (PLY)

Function	Escutcheon		Inside		***Finish (specify)
	Design	Finish	Design	Hand	
FE285	CAM	***	ACC	LH	505,619,620,716
FE285	CAM	***	ACC	RH	505,619,620,716
FE285	CAM	***	GEO		505,609,619,716
FE285	PLY	***	FLA	LH	505,609,613,619,620,625,626,716
FE285	PLY	***	FLA	RH	505,609,613,619,620,625,626,716
FE285	PLY	***	PLY		505,613



Accent(ACC)



Flair(FLA)



Georgian(GEO)

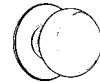

Plymouth(PLY)

©ZIPF LOCK COMPANY

# SIMPLEX



## KEYLESS CONVENIENCE

**Security—without the headache of key management.** Issuing, replacing and controlling keys can be a headache for both large and small facilities. Kaba's® Simplex® mechanical push-button locks eliminate those headaches by using a PIN code instead of keys for access by all authorized users. One code—that's all you have to remember or keep up with—nothing tangible like a key or magnetic card, no batteries to replace in the lock, and no software or computers to control the lock's operation.

**Simple as 1-2-3.** PIN codes are made up of any combination of one to five numbers (pressed individually or simultaneously). The locks allow thousands of possible PIN code combinations. PIN codes are quickly and easily changed without removing the lock from the door. Eliminates normal expense associated with the issue, control, and collection of keys and magnetic cards.

**All buildings, large or small.** Mechanical push-button locks are a great solution for controlling access between public and private areas. The locks are ideal for locations with regular personnel turnover, like data processing centers, employee entrances, research labs, apartment complexes, and dormitories. They perform nicely in conjunction with other security access systems, or as stand-alone security alternatives in smaller building applications.

### SIMPLEX 1000 SERIES HEAVY DUTY LOCK

- Conforms with ANSI A156.2, Grade 1.
- 3-hour UL/ULC Fire rating for "A" label doors.
- Highly weather resistant.
- Vandal resistant, 5 button
- **3-year warranty.**

### To Order, Specify:

Stock No: **SI-1021- Entrance**  
 \*Core Type: **B For Best Type Core**  
 Finish: **26D Satin Chrome**  
**-41**

Core not required on 1011 or 1031 function

### \*SPECIFY CORE TYPE-

- B**-Best, Arrow
- C**-Corbin.Russwin
- S**-Schlage

Cores not furnished—we stock Arrow cores w/Best Keyways and Schlage cores

### STOCK NUMBERS & FUNCTIONS

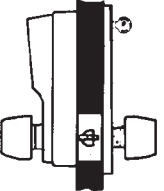
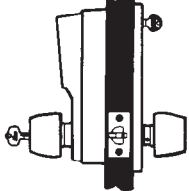
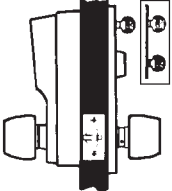
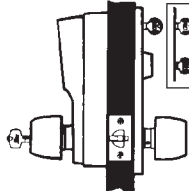
 <p><b>Stock No.</b> <b>SI-1011</b> Standard model. Access by combination.</p>	 <p><b>Stock No.</b> <b>SI-1021*</b> Access by combination or key bypass.</p>	 <p><b>Stock No.</b> <b>SI-1031</b> Access by combination or passage feature. (Passage feature controlled by thumbturn or key-determined at installation)</p>	 <p><b>Stock No.</b> <b>SI-1041*</b> Access by combination, key bypass or passage feature. (Passage feature controlled by thumbturn or key-determined at installation)</p>
---------------------------------------------------------------------------------------------------------------------------------------------------------------------------	--------------------------------------------------------------------------------------------------------------------------------------------------------------------------	----------------------------------------------------------------------------------------------------------------------------------------------------------------------------------------------------------------------------------------------------------	------------------------------------------------------------------------------------------------------------------------------------------------------------------------------------------------------------------------------------------------------------------------

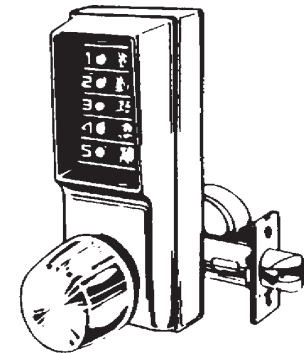

**Combination Code:** One code per lock made of any combination of one to five numbers (pressed individually or simultaneously). **Number of Combinations:** Thousands of possible combinations. **Emergency Access:** Optional mechanical key override.

### SPECIFICATIONS

<b>Lock Body:</b>	Height 7-3/8" x Width 3-1/8" x Depth 3-13/16"
<b>Backset:</b>	2-3/4"
<b>Throw:</b>	1/2"
<b>Strike:</b>	ASA and standard strike included
<b>Door Thick.:</b>	1-3/8" to 2-1/4"
<b>Minimum Stile:</b>	5"
<b>Finishes:</b>	<b>03</b> Bright Brass <b>05</b> Antique Brass <b>26D</b> Satin Chrome

### A NOTE ABOUT THE PASSAGE FUNCTION—

When activated by an inside thumbturn or key cylinder, the outside knob can be set to open the lock without the need for using the pushbutton combination. Designed for use in offices, etc., when the door is to be left unlocked for extended periods.

# SIMPLEX

## SIMPLEX LI000 SERIES HEAVY DUTY LOCK



- Conforms with ANSI A156.2, Grade 1.
- 3-hour UL/ULC Fire rating for "A" label doors.
- Meets A.D.A. accessibility standard.
- Highly weather resistant.
- Vandal resistant, 5 button
- **3-year warranty.**

<b>Stock No.</b>	<b>Handing</b>
SI-LL1011-	Left Hand
SI-LR1011-	Right Hand
SI-LL1021*	Left Hand
SI-LR1021*	Right Hand
SI-LL1031-	Left Hand
SI-LR1031-	Right Hand

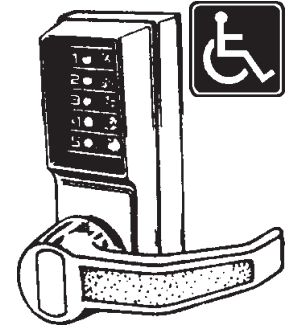

**\*SPECIFY CORE TYPE-**  
**B**-Best, Arrow  
**C**-Corbin.Russwin  
**S**-Schlage

Cores not furnished-we stock Arrow cores w/Best Keyways and Schlage cores

### FUNCTIONS

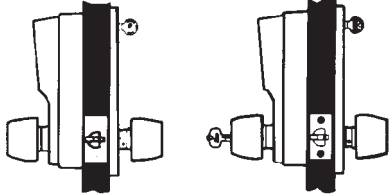

**SI-L 1011** (Lever) Standard model. Access by combination.  
**SI-L 1021\*** (Lever) Access by combination or key bypass.

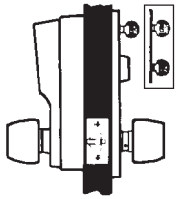

**Stock No.**  
**SI-L1031** (Lever)  
 Access by combination or passage feature. (Passage feature controlled by thumbturn or key-determined at installation)

### To Order, Specify:

Stock No: **SI-LR1021-** Entrance  
 \*Core Type: **B** For Best Type Core  
 Finish: **26D** Satin Chrome  
**-41**

Core not required on 1011 or 1031 function

### SPECIFICATIONS

**Lock Body:** Height 7-3/8" x Width 3-1/8" x Depth 3-13/16"  
**Backset:** 2-3/4"  
**Throw:** 1/2"  
**Strike:** ASA and standard strike included  
**Door Thick.:** 1-3/8" to 2"  
**Minimum Stile:** 5"  
**Finishes:** **03** Bright Brass, **05** Antique Brass, **26D** Satin Chrome

## SIMPLEX EE1000 SERIES HEAVY DUTY LOCK



- Conforms with ANSI A156.2, Grade 1.
- 3-hour UL/ULC Fire rating for "A" label doors.
- Highly weather resistant.
- Vandal resistant, 5 button
- **3-year warranty.**



**ACCESS CONTROL FROM BOTH SIDES OF THE DOOR**

### SPECIFICATIONS

**Lock Body:** Height 7-3/8" x Width 3-1/8" x Depth 3-13/16"  
**Backset:** 2-3/4"  
**Throw:** 1/2"  
**Strike:** ASA and standard strike included  
**Door Thick.:** 1-3/8" to 2"  
**Minimum Stile:** 5"  
**Finishes:** **26D** Satin Chrome

<b>Stock No.</b>	<b>Description</b>
<b>SI-EE1011/EE1011-26D</b>	Combination entry/egrees (special order)
<b>SI-EE1021B/B-26D-41</b>	Combination/Key bypass for entry/egress
<b>SI-EE1021S/S-26D-41</b>	Combination/Key bypass for entry/egress

**B**-for use with Best type cores, **S**-for use with Schlage full size core

**Combination Code:** One code per lock made of any combination of one to five numbers (pressed individually or simultaneously). **Number of Combinations:** Thousands of possible combinations. **Emergency Access:** Optional mechanical key override.

**Need a core for your lock?? Just let us know when ordering.**  
**Need the core keyed?? Just let us know when ordering.**

# SIMPLEX

## E-PLEX E2000 SERIES ELECTRONIC ACCESS CONTROL

- ANSI/BHMA A156.2, Grade 1 Certified.
- 100 access codes - including user and service levels.
- Cylindrical latch. Metal, vandal-resistant keys.
- Simple to install and maintain. No wiring.
- Easy to manage - no software required.
- Non handed - field reversible.
- **2-year warranty. Built-in warranty counter.**

# E-PLEX®

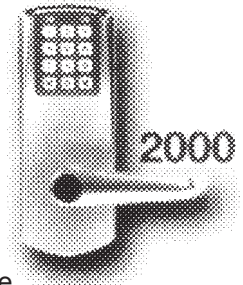

**Stock No.**

**SI-E2031-LL-626-41**

**SI-E2031-XS-LL-626-41**

**Description**

No key override

With key override -Schlage C kwy

**Easy to install:** The E-Plex 2000 easily installs on wood or metal doors with ASA 161 door prep. Three through bolts secure the lock to the door. Requires no wiring to or through the door. Eliminates risk of damage from pinched wires that can result in costly callbacks. Rugged and weather-resistant external housing can be mounted outdoors and includes installation gasket.

**Easy to manage:** With the E-Plex 2000 users and locks are easily managed at the door with simple keypad programming. Multiple operation modes include PIN entry, passage and lockout. Passage mode can be activated by authorized user with assign PIN and pre-programmed to re-lock after a certain number of hours. Four authority levels give you control over who has access to various lock functions.

**Easy to use:** The user friendly design is equipped with ADA compliant levers. Programmable user parameters customize the lock to the needs of different access points. Audio and visual indicators notify users when access is granted or denied. User access code length can be set from 4 to 8 digits. Time interval between combination entry and relocks is variable from 2 to 20 seconds. Anti-tamper feature disables the lock after multiple invalid combination entries—set for between 3 to 9 attempts and up to 90 seconds. **3 AA batteries provide at least 100,000 cycles.**

## SIMPLEX 5000 SERIES EXTRA HEAVY DUTY LOCK

- ANSI/BHMA A156.2, Grade 1 Certified.
- 3-hour UL/ULC Fire rating for "A" label doors.
- Meets A.D.A. accessibility standard.
- Highly weather resistant.
- Vandal resistant, 5 button
- **3-year warranty.**

**To Order, Specify:**

Stock No: **SI-5021-XK-WL-** Entrance

Finish: **26D Satin Chrome**

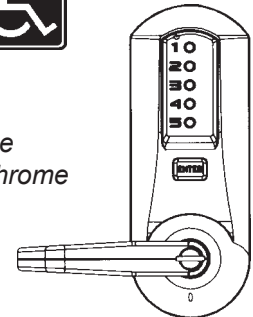

**SPECIFICATIONS**

**Lock Body:** Height 8-7/8" x Width 3-3/8" x Depth 3-3/8"  
**Backset:** 2-3/4"  
**Throw:** 1/2"  
**Strike:** ASA and standard strike included  
**Door Thick.:** 1-3/8" to 2-1/4"  
**Minimum Stile:** 5"  
**Finishes:** **26D** Satin Chrome

**Stock No.**

**SI-5021-XK-WL-**

**SI-5021-XS-WL-**

**\*SI-5021-B-WL-**

**\*SI-5021-S-WL-**

**Key Override**

Key-in-Lever Kaba 90 Keyway

Key-in-Lever Schlage C Keyway

Best & compatibles (core not included)

Schlage I/C (core not included)

\*Special order. Please specify if core required.

Ideal for high-traffic security-sensitive area where access control is required. **Combination Code:** One code per lock made of any combination of one to five numbers (pressed individually or simultaneously). **Number of Combinations:** Thousands of possible combinations. **Code Changing:** Accomplished with the lever release combination change tool from the lock exterior (5021) or from the interior (5031-special order). **Emergency Access:** Mechanical key override.

• SEE NEXT PAGE FOR E-PLEX E5000 SERIES •

# SIMPLEX

## E-PLEX E5000 SERIES ELECTRONIC ACCESS CONTROL

- ANSI/BHMA A156.2, Grade 1 Certified.
- 3-hour UL/ULC Fire rating for "A" label doors.
- Meets A.D.A. accessibility standard.
- Both housings are weather resistant.
- Four bolt installation - **no wiring**.
- Non handed - field reversible.
- **3-year warranty. Built-in warranty counter.**

# E-PLEX®



### SPECIFICATIONS

**Backset:** 2-3/4"  
**Throw:** 1/2"  
**Strike:** ASA and standard strike included  
**Door Thick.:** 1-3/8" to 2-1/4"  
**Minimum Stile:** 5"  
**Finishes:** 26D Satin Chrome

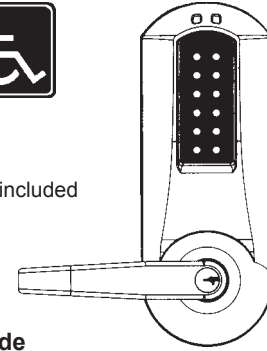

Height:  
8-7/8"  
Width:  
3-3/8"

### Stock No.

**SI-E5031XK-WL-626**

### Key Override

Key-in-Lever Kaba 90 Keyway

The E-Plex 5000 Series combines the strength, simplicity and reliability of Simplex® mechanical push-button locks with the added security and features of electronic access control - it's never been easier to Power Up your access control. Controls access with up to 100 access codes. Exterior access is by combination or key override, and egress is by interior lever and is free at all times.

**Applications:** Ideal for controlling access to security sensitive areas in commercial, industrial, educational, governmental, healthcare, lodging, and multi-unit residential settings. It's perfect for restricted areas with a high user turnover rate.

**Keyless convenience:** Eliminates problems and costs associated with issuing, controlling, and collecting keys and magnetic cards.

**Flexible operational modes:** Combination (PIN) entry, Passage (programmable), Lockout.

**Easy to manage:** User access programmed at the lock or managed with **optional** Microsoft Excel™ based software. Users quickly added and deleted. Optional software provides increased control as facility's users and access points increase. Five authority levels allow you to control user's access to various lock functions: Master, Manager, User, Service and Maintenance. Service level has authority to gain access once, or programmed for 1 to 24 hours - for service personnel, meeting rooms, and rental space.

**Extensive audit trail for added security:** Lock records last 3,000 events for user accountability. Audit includes mechanical key override use.

**Flexible user preferences:** Adjustable anti-tamper lockout disables lock after 3 to 9 invalid entry attempts for up to 90 seconds. Adjustable relock time after combination entry from 2 to 20 seconds. Variable length access codes set from 4 to 8 digits.

**Additional Specifications:** (4) four AA Alkaline batteries-located in interior housing; Battery life up to 180,000 cycles; Lock data is retained if batteries fail; audible and visual indicators; low battery visual indicator.

## SIMPLEX 2015 SERIES EXIT DEVICE CONTROL

- Highly weather resistant.
- Vandal resistant, 5 button
- 1-year warranty.

### SPECIFICATIONS

**Lock Body:** Height 8-5/8" x Width 3-1/8" x Depth 2-3/4"  
**Tailpiece:** 2-3/4" tailpiece for exit device operation from outside  
**Door Thick.:** 1-3/8" to 2-1/2"  
**Handing:** For non-handed or clockwise-rotating exit device hubs only (adjustable up to 90°)  
**Minimum Stile:** 5"  
**Finishes:** 26D Satin Chrome



6-pin tumbler cylinder keys for combination change access. Keyed Different.

Exit device & handle not included. Order separately.

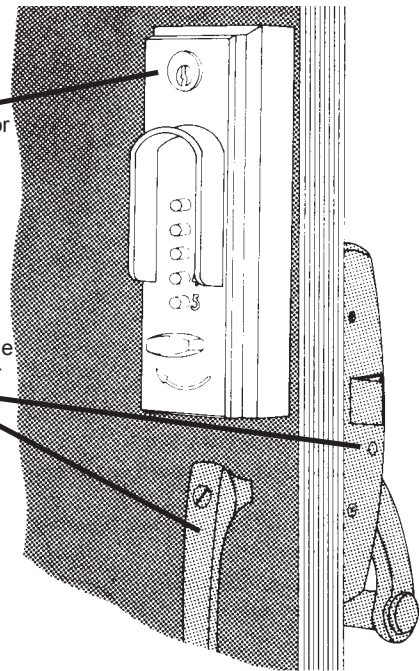

### Stock No.

**SI-2015-26D-41**

### Finish

Satin Chrome

### EXIT DEVICE COMPATIBILITY:

**Von Duprin:** 22, 22F, 88, 88F, 98, 98F, 99, 99F RIMS; 2227, 2227F, 9827, 9827F, 9847, 9847F, 9927F, 9947F.

**American Device:** 6300, 6303.

**Detex Advantex Series:** 10, 20, 21, 40, 50, 51.

**Monarch:** 18RBA, 18RP, 18VP, F18RBA, F18RP, F18VP, FXXRBA, FXXRP, FXXVP, XXRBA, XXRP, XXVP

**Yale:** 1500, 7000.

**Corbin:** 21, 22, 25, 26NT, 27K, 29, 29-1/4, 29M2, 29-1/2M2, 29NTM2, 29D20, LA29, 39, 39EL, 39LLD, 390, LA39.

**Russwin:** 365, 3651/4, LT365, 370, 372, LA372, 375, LT375, 377, 382, 384, 385, 388, 572, 572EL, 572ELD, U572, LA572.

**Sargent:** 2813, 2804, 6804, 12-6804, 9804RHRB, 12-9804LHRB, 9898E, 9898K.

©ZIPF LOCK COMPANY

# SIMPLEX

**Application**—Model LP1000 and 2015(next page) exit device controls are designed to operate surface mount (rim-mounted) exit devices from the outside using a tailpiece, which replaces the key cylinder on new or existing devices. Any standard pull can be mounted with model 2015. They provide exterior access by combination, while allowing free egress at all times by interior exit device. The locks can be used with many leading brands of surface-mounted (rim-mounted) exit devices.

## SIMPLEX LP1000 SERIES EXIT DEVICE OPERATOR

- Conforms with ANSI A156.2, Grade 1.
- 3-hour UL/ULC Fire rating for "A" label doors.
- Highly weather resistant.
- Vandal resistant, 5 button
- **3-year warranty.**

### SPECIFICATIONS

**Lock Body:** Height 8-3/4" x Width 4-3/8" x Depth 3-7/8"  
**Tailpiece:** 2-3/4" tailpiece for exit device operation from outside  
**Door Thick.:** 1-3/8" to 2-1/4"  
**Handing:** Handed, not reversible  
**Minimum Stile:** 5"  
**Finishes:** 26D Satin Chrome

### EXIT DEVICE COMPATIBILITY:

**Von Duprin:** Exit Only (EO) or Exit Only Fire (EOF) 22, 88 NL, 98, 99, 9857, 9957.  
**Detex Advantex Series:** 10, 20, 21, 40, 50, 51.  
**Dorma:** 9100, 9300, 9400.  
**Monarch:** XXR\*, FXXR\*, 18R\*, F18R\*, XXV\*, FXXV\*, 18V\*, F18V\*.  
 (\*Requires special K adapter)  
 Can not be used with mortise design or most vertical rod exit device.

**Need a core or exit device??  
Just let us know.**

LP1000 Series can not be used with mortise design and most vertical rod exit devices.

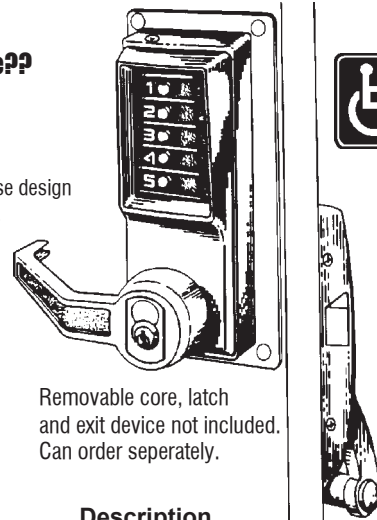

Removable core, latch and exit device not included. Can order seperately.

### Stock No.

**SI-LLP1020B-26D-41**  
**SI-LRP1020B-26D-41**  
**SI-LLP1020S-26D-41**  
**SI-LRP1020S-26D-41**

### Description

Left Hand, For Best type core  
 Right Hand, For Best type core  
 Left Hand, For Schlage full size core  
 Right Hand, For Schlage full size core

**Application**—Model 3000 series locks provide fully mechanical pushbutton access control for narrow stile aluminum glass doors. It provides exterior access by combination or key override, while allowing free egress at all times.

Model 3000 series is designed for use with Adams Rite 4510/4710 latch mechanisms and most Adams Rite egress hardware (order separately). Any standard MS mortise cylinder that operates the Adams Rite latch will function with the 3000 series lock. Suitable for inswing and outswing doors.

## SIMPLEX 3000 SERIES NARROW STILE LOCKS



- Highly weather resistant.
- Vandal resistant, 5 button
- 1-year warranty.

### SPECIFICATIONS

**Lock Body:** Height 9-5/8" x Width 1-17/32" x Depth 2-5/8"  
**Backset:** 3010, 3020 31/32"; 3030, 3040 1-1/8"  
**Stile Width:** 1-7/8" minimum required for mounting  
**Door Thick.:** 1-3/4" maximum

### Features:

**Key override** can be used to override the lock combination and gain access using a key. This feature allows facilities to initiate or maintain a master-keyed security system. The lock accepts MS (maximum security) mortise cylinders.

**Passage (latch holdback)** allows access without using the lock entry code, keeping the door unlocked. This feature is activated from the outside with a key.

**Lockout** disables the lock so that entry codes cannot be used to gain access. Access is permitted using the key override only. This feature is activated from the outside using the override key.

You must order housing and drive assembly for complete lock

LATCH NOT INCLUDED  
Order separately.

CYLINDER NOT INCLUDED  
Order separately.

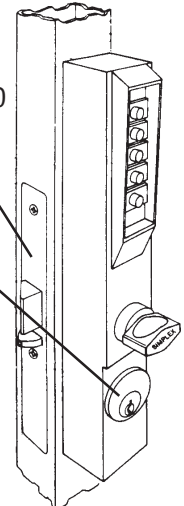

### Housing—

#### Stock No.

**SI-3001-26D-41**  
**SI-3001-55-41**

#### Finish

Satin Chrome  
 Duranodic

### Drive Assembly—

#### Stock No.

**SI-3010-19-41**  
**SI-3020-19-41**  
**SI-3030-19-41**  
**SI-3040-19-41**

#### Backset and Handing

31/32" backset RH or RHRB  
 31/32" backset LH or LHRB  
 1-1/8" backset RH or RHRB  
 1-1/8" backset LH or LHRB

©ZIPF LOCK COMPANY

# SIMPLEX

## SIMPLEX 900 SERIES LIGHT COMMERCIAL/ RESIDENTIAL LOCK



### Deadbolt Function—

To open from outside, press combination and turn front knob to open. The lock remains open (bolt retracted) until either the inside lever or outside knob is turned to throw bolt into locked position.

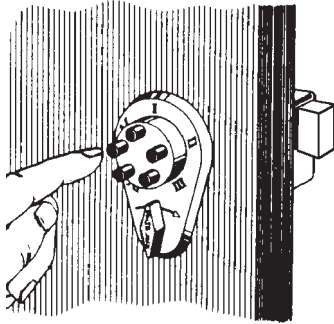

### SPECIFICATIONS

**Backset:** Outswing door: 2-9/16"  
Inswing door: 2-1/2"  
**Latch:** On Deadbolt lock 1"  
**Keypad:** Vandal resistant, 5 button.  
**Handing:** Field reversible latch. Invert lock for right hand door.  
**Bore:** 1-5/8" for barrel, 3/4" for thumbturn, 7/8" for key override

**\*Door Thickness:**  
1-3/8" for 1-3/8" to 1-1/2" thick doors  
1-3/4" for 1-3/4" to 2-1/8" thick doors

### Spring Latch Function (Night Latch)—

Locks automatically when door closes and requires correct combination to re-open from outside. Can always be opened from inside by turning lever. The thumb slide on inside housing is used to hold the deadlocking latch in a retracted position to keep the Simplex lock open, when desired. For doors that swing out, the latch bolt can be reversed.

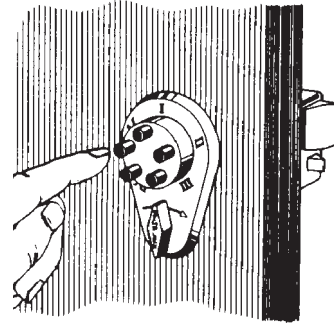

### •Deadbolt door lock with 1" bolt—

Stock No.	Thick*	Finish
SI-9020000-04-41	1-3/8"	Satin Brass
SI-9020000-26D-41	1-3/8"	Satin Chrome
SI-9040000-04-41	1-3/4"	Satin Brass
SI-9040000-26D-41	1-3/4"	Satin Chrome

### •Above Lock With Key By-pass Cylinder—

Stock No.	Thick*	Finish
SI-9060000-04-41	1-3/8"	Satin Brass
SI-9060000-26D-41	1-3/8"	Satin Chrome
SI-9100000-04-41	1-3/4"	Satin Brass
SI-9100000-26D-41	1-3/4"	Satin Chrome

### •Spring Latch door lock with hold back—

Stock No.	Thick*	Finish
SI-9170000-04-41	1-3/8"	Satin Brass
SI-9170000-26D-41	1-3/8"	Satin Chrome
SI-9190000-04-41	1-3/4"	Satin Brass
SI-9190000-26D-41	1-3/4"	Satin Chrome

### •Above Lock With Key By-pass Cylinder—

Stock No.	Thick*	Finish
SI-9350000-04-41	1-3/8"	Satin Brass
SI-9350000-26D-41	1-3/8"	Satin Chrome
SI-9380000-04-41	1-3/4"	Satin Brass
SI-9380000-26D-41	1-3/4"	Satin Chrome

### Key By-pass Option—

Above models (deadbolt & night latch) are available with an optional key cylinder that provides the flexibility of a master key system and the security advantages of a combination lock. Employees, tenants, etc., use the pushbutton combinations. The key insures entry, regardless of the combination setting used.

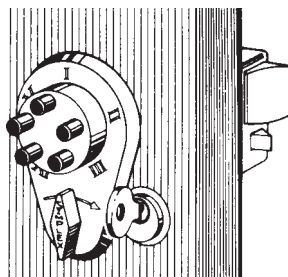

### INSIDE VIEW of Spring (Night) Latch Function

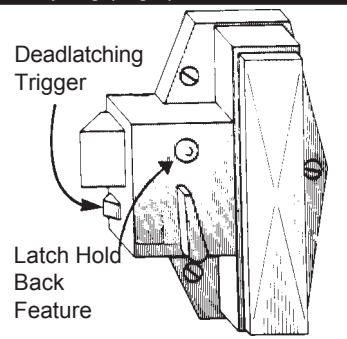

### Adapter Kit For Metal Door & Frame Installations—

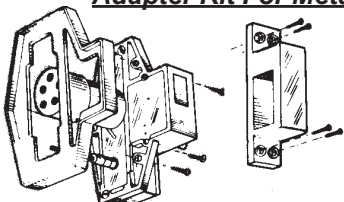

**Brass Finish** SI-800-04-41  
**Chrome Finish** SI-800-26D-41

Adapter kit containing a special surface-mounted cast strike and adjustable riser plate as shown is available. The special strike is fastened to the inside surface of the metal frame and eliminates the need to cut or mortise the frame for the standard strike. The adjustable riser plate raises the lock housing to ensure proper alignment of the latch or dead bolt with the special strike.

### For Wood Door And Frame Installation—

Just drill two holes—one 7/8" and one 1-5/8". All Simplex 900 Series Door Locks require a minimum flat surface of 3-3/4" on inside of door to mount. FOR METAL DOOR INSTALLATION, YOU SHOULD ORDER EITHER THE SI-800-04-41 OR SI-800-26D-41 ADAPTER KIT

# SIMPLEX



## SIMPLEX 6200 SERIES LIGHT COMMERCIAL/ RESIDENTIAL LOCK

- 3-hour UL/ULC fire rating for "A" label doors
- Vandal resistant, 5 button
- Retrofits 2-1/8" standard bore cylindrical locksets

### SPECIFICATIONS

**Lock Body:** Height 8-7/8" x Width 2-3/4" x Depth 2-9/16"  
**Backset:** 2-3/4"  
**Throw:** 1/2"  
**Bore:** 2-1/8"  
**Strike:** T-strike with strike box  
**Door Thick.:** 1-3/8" to 2-1/4"  
**Minimum Stile:** 5"  
**Handing:** Factory handed left, field reversible

Access by combination, while allowing free egress at all times by interior knob. The lockset automatically relocks each time the door closes. The lock can be inverted if the existing auxiliary lock obstructs installation.

**Combination Code:** One code per lock made of any combination of one to five numbers (pressed individually or simultaneously). **Number of Combinations:** Thousands of possible combinations.

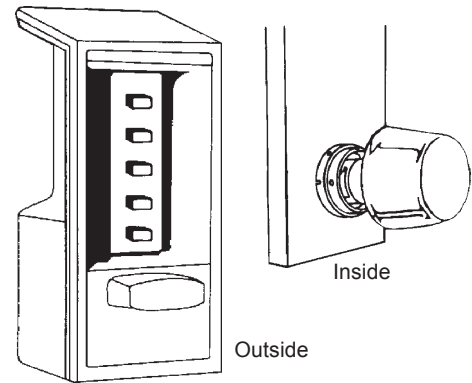

<u>Stock No.</u>	<u>Finish</u>
SI-6204-60-41	Gold Tone
SI-6204-85-41	Black
SI-6204-86-41	Grey

## SIMPLEX 7100 SERIES LIGHT COMMERCIAL/ RESIDENTIAL LOCK

- Vandal resistant, 5 button

### SPECIFICATIONS

**Lock Body:** Height 8-7/8" x Width 2-3/4" x Depth 2-9/16"  
**Backset:** varies by model number  
**Throw:** varies by model number  
**Bore:** 1-3/8" x 1" (except 7106: 3/4")  
**Strike:** **7102, 7108:** Flat strike  
**7104:** curved lip strike  
**7106:** box strike for inswing door, flat or outswing doors  
**Door Thick.:** 1-3/8" to 2-1/4"  
**Minimum Stile:** 4"  
**Handing:** Field reversible

The 7100 Series lockset provides fully mechanical primary or auxiliary push-button access control by exterior combination, while allowing free egress at all times by interior thumbturn. Deadbolt models are manually relocking. Deadlocking models automatically relock each time the door closes. 7100 Series locks mount above the existing lockset, or can be used alone.

**Combination Code:** One code per lock made of any combination of one to five numbers (pressed individually or simultaneously). **Number of Combinations:** Thousands of possible combinations.

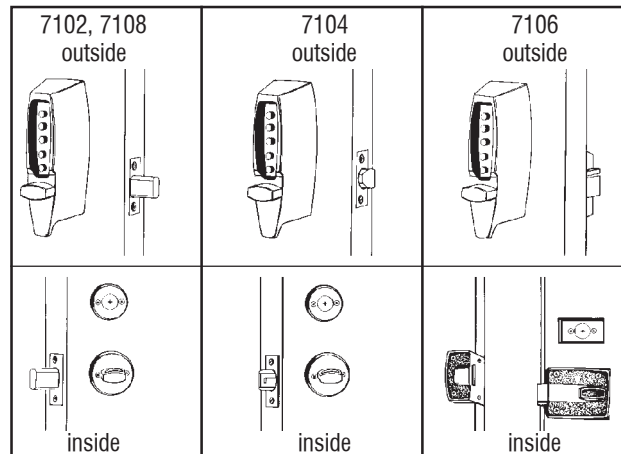

<u>Stock No.</u>	<u>Finish</u>
• 1" deadbolt, 2-3/4" backset, Manual relock.	
SI-7102-03-41	Bright Brass
SI-7102-26D-41	Satin Chrome
• 1" deadbolt, 2-3/8" backset, Manual relock.	
SI-7108-03-41	Bright Brass
• 1/2" deadlocking latch, 2-3/8" - 2-3/4", Auto relock.	
SI-7104-03-41	Bright Brass
SI-7104-26D-41	Satin Chrome
• 5/8" deadlocking latch (surface), 2-3/8" backset, Auto relock & latch holdback. For wood doors only.	
SI-7106-19-41	Black (Powder Paint)
SI-7106-26D-41	Satin Chrome

**We are your source for Simplex**

*The 7000 Series is changing to the 7100 Series.*

©ZIPF LOCK COMPANY

# WEISER

6 locks per case

## KEYLESS HOME ACCESS SYSTEM

### Powerbolt Deadbolts

- 1" projection deadbolt latch with 1/4" diameter hardened steel free-turning roller.
- Easy to Install, Easy to Program, Easy to Use.
- Requires 4 "AA" alkaline batteries (not included).
- Residential 1-Year Electrical components warranty.
- Residential Lifetime Mechanical warranty.
- Residential Lifetime Finish warranty.

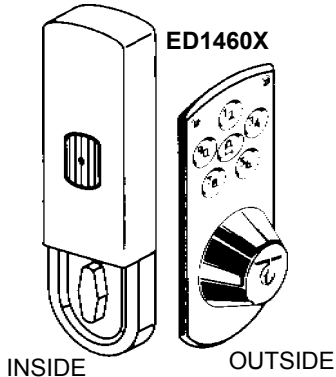

# WEISER LOCK™

## Powerbolt

### SPECIFICATIONS

<b>DOOR THICKNESS:</b>	1-3/8" to 2"
<b>BACKSET:</b>	Adjustable 2-3/8" to 2-3/4"
<b>BORE:</b>	2-1/8" x 1"
<b>BOLT THROW:</b>	1"
<b>FINISHES:</b>	<b>US-3<sup>B</sup></b> Bright Brass <b>US-15</b> Satin Nickel <b>US-26D<sup>B</sup></b> Satin Chrome

<sup>B</sup>Brilliance Finish is standard on exterior side of locks.-

*Other finishes available by special order.*

### HOW TO ORDER: Specify,

Function: **ED1460X** Single Cylinder  
Finish: **US-3** Bright Brass  
Latch: **AL** Adjustable

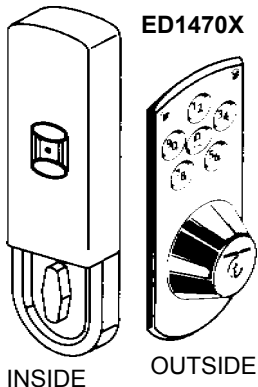

**Stock No.**  
**ED1460X**

#### Operation

**Single Cylinder Deadbolt**-Deadbolt latch retracted by entering security code outside and extended by pushing lock button outside. Deadbolt latch extended and retracted by T-Turn on inside. Using key outside will retract deadbolt latch if needed.

**ED1470X**

**Same as above except** includes push button lock and unlock buttons on inside to extend or retract deadbolt.

### Electronic Keyless Entry System

- Simply enter your personalized access code for convenient, quick and carefree entry.
- You may also program a temporary second code for a neighbor, cleaning crew, etc.
- Alarm sounds after 3 consecutive incorrect codes are entered.
- Easy-one touch locking.
- Heavy duty security deadbolt and strike plate resist break-ins.
- No wiring necessary (add 4 Alkaline "AA" batteries).
- Low battery indicator.
- Fits standard preparation on new doors.
- Easily replaces existing door hardware.

***We also stock Kwikset's 907 Series Powerbolt.***

©ZIPF LOCK COMPANY

**230** v1  
(PL-14)