

ARROW

12 locks per case.

HEAVY DUTY-H Series

- ANSI A156.2, Series 4000, Grade 1
- Conforms to Fed. Specs FFH-106C, Type 161
- U.L. Listed for "A" labeled or lesser doors
- For Heavy Duty Commercial



SPECIFICATIONS

DOOR THICKNESS: 1-3/8" to 2"
BACKSET: 2-3/4" Square Corner 1-1/8" wide face
BORE: 2-1/8" x 1"
ROSE: 3-1/4"
KEYWAY: Arrow "A" drilled for 6
FINISHES: **US-26D** Satin Chrome

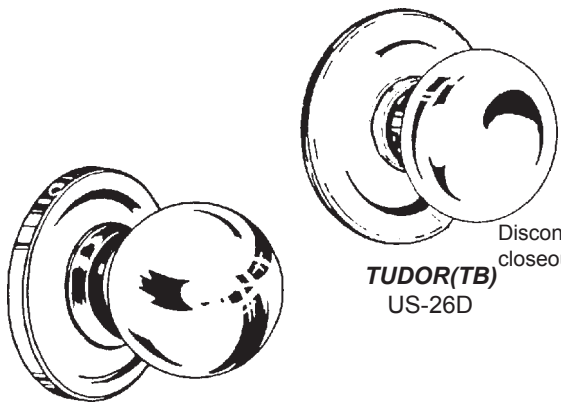

BALL(BB)
US-26D

TUDOR(TB)
US-26D

Discontinued-Call for closeout prices

To Order, Specify:

Function: **H11** Entrance
 Design: **TB** Tudor
 Finish: **US-26D** Satin Chrome

H11TB-IC US-26D

Not all functions are available in all designs/finishes

Function	Knob No.	Lever No.	Operation
ENTRANCE	H11	Q11	Latch by knob/lever either side except when pushing turn button locks outside knob/lever. Unlocked by turning inside knob/lever or using key outside. Turning inside button keeps outside knob/lever locked. Key will retract latch.
STOREROOM	H12	Q12	Latch by inside knob/lever. Outside knob/lever always rigid. Key will retract latch.
CLASSROOM	H17	Q17	Latch by knob/lever either side except when key locks outside knob/lever. Key will unlock knob/lever.

HEAVY DUTY-Q Series

- ANSI A156.2, Series 4000, Grade 1
- ANSI A117.1 Accessibility Code
- Conforms to Fed. Specs FFH-106C, Type 161
- U.L. Listed for "A" labeled or lesser doors
- For Heavy Duty Commercial

Discontinued - call for closeout prices

12 locks per case.



SPECIFICATIONS

DOOR THICKNESS: 1-3/4" to 2"
BACKSET: 2-3/4" Square Corner 1-1/8" wide face
BORE: 2-1/8" x 1"
ROSE: 3-5/16"
KEYWAY: Furnished Less Cylinder.
FINISHES: **US-26D** Satin Chrome

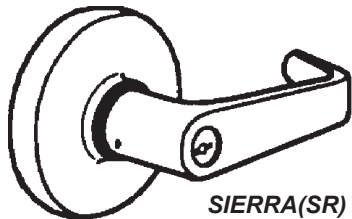

SIERRA(SR)
US-26D

To Order, Specify:

Function: **Q11** Entrance
 Design: **SR** Sierra
 Finish: **US-26D** Satin Chrome
 Cylinder: **-LC*** Less Cylinder

**Stocked LESS CYLINDER (LC). Specify when ordering if cylinder is required*

ARROW

12 locks per case.

HEAVY DUTY-H Series INTERCHANGEABLE CORE

- ANSI A156.2, Series 4000, Grade 1
- Conforms to Fed. Specs FFH-106C, Type 161
- U.L. Listed for "A" labeled or lesser doors
- For Heavy Duty Commercial



SPECIFICATIONS

DOOR THICKNESS: 1-3/8" to 2"
BACKSET: 2-3/4"
BORE: 2-1/8"
ROSE: TB: 3-1/4"
FINISHES: **US-26D** Satin Chrome

To Order, Specify:

Function: **H11** Entrance
 Design: **TB** Tudor
 -IC Interchangeable Core
 Finish: **US-26D** Satin Chrome

H11TB-IC US-26D

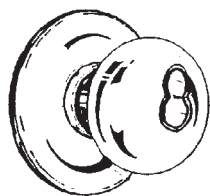

TUDOR(TB)
US-26D

Function	Knob No.	Lever No.	Operation
ENTRANCE	H11TB-IC	Q11SR-IC	Latch by knob/lever either side except when pushing turn button locks outside knob/lever. Unlock by turning inside knob/lever or using key outside. Turning inside button keeps outside knob/lever locked. Key will retract latch.
STOREROOM	H12TB-IC	Q12SR-IC	Latch by inside knob/lever. Outside knob/lever always rigid. Key will retract latch.

HEAVY DUTY-Q Series INTERCHANGEABLE CORE

- ANSI A156.2, Series 4000, Grade 1
- ANSI A117.1 Accessibility Code
- Conforms to Fed. Specs FFH-106C, Type 161
- U.L. Listed for "A" labeled or lesser doors
- For Heavy Duty Commercial

12 locks per case.

SPECIFICATIONS

DOOR THICKNESS: 1-3/8" to 2"
BACKSET: 2-3/4"
BORE: 2-1/8"
ROSE: TB: 3-1/4"
FINISHES: **US-26D** Satin Chrome



To Order, Specify:

Function: **Q11** Entrance
 Design: **SR** Sierra
 -IC Interchangeable Core
 Finish: **US-26D** Satin Chrome

Q11SR-IC US-26D

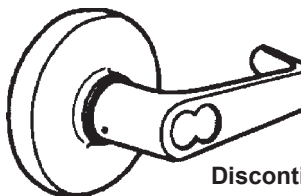

SIERRA(SR)
US-26D

Discontinued-Call for closeout prices

NOTE: Locks do not come with cores and must be ordered SEPARATELY. Locks will accept Arrow, Best and Falcon 7 pin cores. To use a 6 pin core you must order AR-CH6-44 or AR-CL69-44 (6 pin tailpiece assembly)

6-PIN TAILPIECE ASSEMBLIES

AR-CH6-44 6 pin tailpiece assembly for "H" Series IC

AR-CL69-44 6 pin tailpiece assembly for "Q" Series IC

UNCOMBINATED CORES

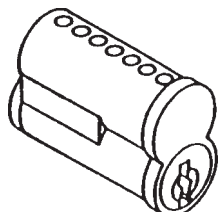

Stock No. **Description**
AR-C6S-UC- 6 pin core
AR-C7S-UC- 7 pin core

Keyways stocked:
 ARROW: **1D**
 BEST: **AB, BB, DB, EB, FB, GB, HB, JB, KB, MB**

TO ORDER CORE, SPECIFY: Stock No. + Keyway Code + Finish = AR-C7S-UC-AB 26D

ARROW

STANDARD DUTY-M Series

- ANSI A156.2, Series 4000, Grade 2
- Standard Duty For Light Commercial
- Sierra-Medium Duty Lock Built On Heavy Duty Chassis



24 locks per case.
Lever-12 locks.

ANSI A117.1
Accessibility Code



Call for availability. Some locks are discontinued.

Thru-bolted within
161 prep

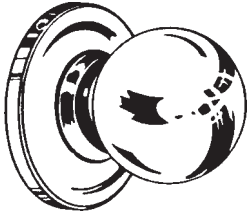

BALL(BD)
US-3, 26D

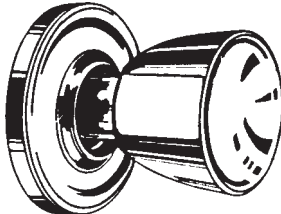

DARRIN(DD)
US-3, 5A, 26D

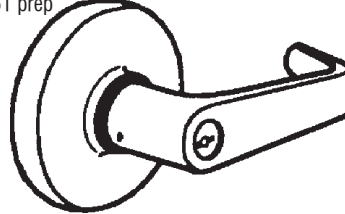

SIERRA(SR)
US-3, 26D
2-3/4" only U.L. Listed

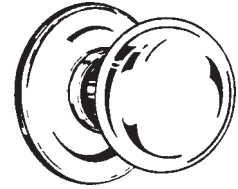

TUDOR(TA)
US-3, 5A, 26D

<u>Function</u>	<u>Knob No.</u>	<u>Lever No.</u>	<u>Operation</u>
PASSAGE	MK01	ML01	Latch by knob/lever either side.
PRIVACY	MK02	ML02	Latch by knob/lever either side except when inside push button locks outside knob/lever. Unlocked by turning inside knob/lever, closing door or turning outside emergency slot.
DUMMY	MK08	—	1/2 dummy trim (no latch).
ENTRANCE	MK11	ML11	Latch by knob/lever either side except when pushing turn button locks outside knob/lever. Unlock by turning inside knob/lever or using key outside. Pushing and Turning inside button keeps outside knob/lever locked. Key will retract latch.
STOREROOM	MK12	ML12	Latch by inside knob/lever only. Outside knob/lever always rigid. Key will retract latch.
CLASSROOM	MK17	ML17	Latch by knob/lever either side except when key locks outside knob/lever. Key will unlock knob/lever.
COMMUNICATING	MK31	ML31	Latch by knob/lever either side except when key locks its own knob/lever.
PUBLIC ENTRANCE	MK32	ML32	Latch key knob/lever either side except when outside knob/lever is locked by inside key. Outside key will retract latch.
FIXED KNOBS	MK33	ML33	Both knobs/levers always rigid. Either key will retract latch.

To Order, Specify:

Function: **MK11** Entrance
 Design: **TA** Tudor
 Finish: **US-26D** Satin Chrome
 Latch: **234** 2-3/4" Backset

Not all functions are available in all designs/finishes
CS-Some locks available with "C" keyway, suffix **-CS**

SPECIFICATIONS

DOOR THICKNESS: 1-3/8" to 1-3/4"
BACKSET: 2-3/8", 2-3/4"
BORE: 2-1/8" x 7/8"
ROSE: 3-1/2" for Sierra
 2-9/16" for balance
KEYWAY: Arrow "A" drilled for 6
 (pinned for 5)
FINISHES: **US-3** Polished Brass
US-5A Antique Brass
US-26D Satin Chrome

NOTE: Unless otherwise specified 2-3/8" square face latch is standard. Specify DI for drive in. The Sierra is 2-3/4" backset U.L. listed only. Many of the locks are available with 2-3/4" UL Listed deadlatch or ASA strike...Call.

ARROW

24 locks per case.

STANDARD DUTY-M Series INTERCHANGEABLE CORE

- ANSI A156.2, Series 4000, Grade 2
- For Light Commercial

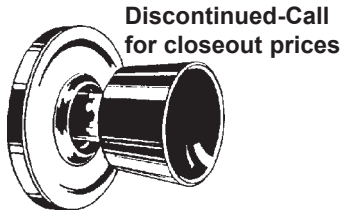

DARRIN(DD)
US-26D

Discontinued-Call
for closeout prices

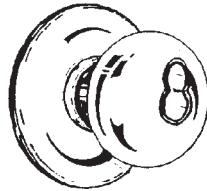

TUDOR(TA)
US-26D

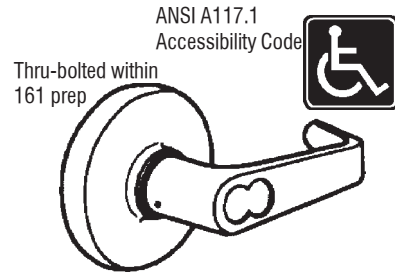

SIERRA(SR)
US-26D
2-3/4" only U.L. Listed

Function	Knob No.	Lever No.	Operation
ENTRANCE	MK11__-IC	ML11SR-IC	Latch by knob/lever either side except when pushing turn button locks outside knob/lever. Unlock by turning inside knob/lever, or using key outside. Turning inside button keeps outside knob/lever locked. Key will retract latch.
STOREROOM	MK12__-IC	ML12SR-IC	Latch by inside knob/lever only. Outside knob/lever always rigid. Key will retract latch.
CLASSROOM	MK17__-IC	ML17SR-IC	Latch by knob/lever either side except when key locks outside knob/lever. Key will unlock knob/lever.

To Order, Specify:

Function: **MK11** Entrance
 Design: **TA** Tudor
 -IC Interchangeable core
 Finish: **US-26D** Satin Chrome
 Latch: **234** 2-3/4" Backset
Not all functions are available in all designs/finishes

SPECIFICATIONS

DOOR THICKNESS: 1-3/8" to 1-3/4"
BACKSET: 2-3/4"
BORE: 2-1/8"
ROSE: 3-1/2" for Sierra
 2-9/16" for balance
FINISHES: **US-26D** Satin Chrome

NOTE: Locks do not come with cores and must be ordered SEPARATELY. Locks will accept Arrow, Best and Falcon 7 pin cores. To use a 6 pin core you must order AR-CH6-44 or AR-CL69-44 (6 pin tailpiece assembly)

6-PIN TAILPIECE ASSEMBLIES

AR-CM6-44 6 pin tailpiece assembly for "MK" Series IC

AR-CL6-44 6 pin tailpiece assembly for "ML" Series IC

UNCOMBINED CORES

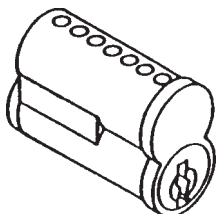

Stock No. **Description**
AR-C6S-UC- 6 pin core
AR-C7S-UC- 7 pin core

Keyways stocked:
 ARROW: 1D
 BEST: AB, BB, DB, EB, FB, GB, HB, JB, KB, MB

TO ORDER CORE, SPECIFY: Stock No. + Keyway Code + Finish = AR-C7S-UC-AB 26D

©ZIPF LOCK COMPANY

ARROW

LIGHT DUTY-L Series

- ANSI A156.2, Series 4000, Grade 2
- ANSI A117.1 Accessibility Code
- U.L. Listed For 3 Hour, A Label Doors
- Light Commercial For Interior Doors
- Ideal For Commercial Applications Where Heavy-Duty Grade Levers May Not Be Required



12 locks per case.

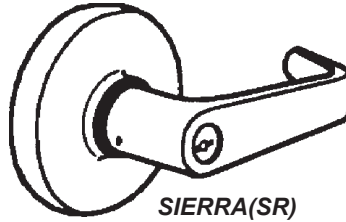

SIERRA(SR)
US-26D



Discontinued-Call for closeout prices

Function	No.	Operation
PASSAGE	L01	Latch by lever either side.
PRIVACY	L02	Latch by lever either side except when inside push button locks outside lever. Unlocked by turning inside lever, closing door or turning outside emergency slot.
ENTRANCE	L11*	Latch by lever either side except when pushing turn button locks outside lever. Unlocked by turning inside lever or using key outside. Pushing and Turning inside button keeps outside lever locked. Key will retract latch.
STOREROOM	L12*	Latch by inside lever. Outside lever always rigid. Key will retract latch.
CLASSROOM	L17*	Latch by lever either side except when key locks outside lever. Key will unlock lever.

To Order, Specify:

Function: **L11** Entrance
 Design: **SR** Sierra
 Finish: **US-26D** Satin Chrome
 Cylinder: **-LC*** Less Cylinder

**Stocked LESS CYLINDER (LC). Specify when ordering if cylinder is required*

SPECIFICATIONS

DOOR THICKNESS: 1-3/8" to 1-3/4"
BACKSET: 2-3/4" Square Corner 1-1/8" wide Face. U.L. Listed
BORE: 2-1/8" x *7/8"
 *Latch sleeve supplied for 1"
ROSE: 3-5/16"
KEYWAY: Less Cylinder, Specify if cylinder is required.
FINISHES: **US-26D** Satin Chrome

ARROW

D60 SERIES GRADE 1 EXTRA HEAVY DUTY DEADLOCKS



12 locks per case.

US-3 discontinued-
Call for closeout prices

ANSI A156.5, Grade 1

- Two piece housing with free spinning outer ring
- Concealed screws on double cylinder function
- 1" throw, solid steel deadbolt w/hardened steel pin
- 2 strikes supplied, one for steel frame, one for wood frame

SPECIFICATIONS

DOOR THICKNESS: 1-3/8" to 1-3/4"
BACKSET: 2-3/4"
BOLT THROW: 1"
BORE: 2-1/8"
KEYWAY: Arrow "A" drilled for 6 (pinned to 5)
FINISH: **US-3** Polished Brass
US-26D Satin Chrome

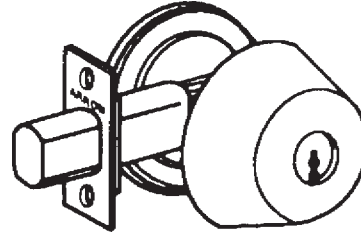

D61 Single Cylinder
D62 Double Cylinder

D60 SERIES GRADE 1 - EXTRA HEAVY DUTY INTERCHANGE- ABLE CORE DEADLOCKS

12 locks per case.

*Less cores. See
page 112 for cores.*

ANSI A156.5, Grade 1

- Same features as D60 Series above.

SPECIFICATIONS

DOOR THICKNESS: 1-3/8" to 1-3/4"
BACKSET: 2-3/4"
BOLT THROW: 1"
BORE: 2-1/8"
KEYWAY: Uses interchangeable core
(not included-order separately)
FINISH: **US-26D** Satin Chrome

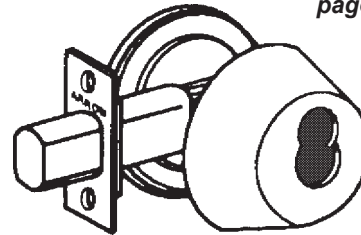

D61-IC Single Cylinder
D62-IC Double Cylinder

E60 SERIES GRADE 2 HEAVY DUTY DEADLOCKS

24 locks per case.

ANSI A156.5, Grade 2

- Two piece housing with free spinning outer ring
- Concealed screws on double cylinder function
- Full 1/4" steel thru-bolts
- 1" throw, solid steel deadbolt w/hardened steel pin
- 2 strikes supplied, one for steel frame, one for wood frame

SPECIFICATIONS

DOOR THICKNESS: 1-3/8" to 1-3/4"
BACKSET: 2-3/8", 2-3/4"
BOLT THROW: 1"
BORE: 2-1/8"
KEYWAY: Arrow "A" drilled for 6 (pinned to 5)
E61, E62 in 3 & 26D also available with "C"
FINISH: **US-3** Polished Brass
US-5A Antique Brass
US-26D Satin Chrome

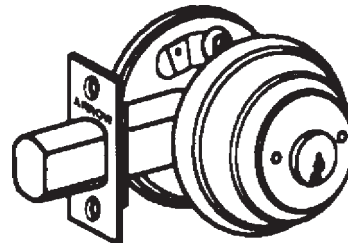

E61 Single Cylinder
E62 Double Cylinder

©ZIPF LOCK COMPANY

ARROW

DOUBLELOCK

6 locks per case.



FEATURES:

- Recessed cylinder resist jimmying, prying, wrenching and cutting
- Single turn of knob retracts both bolts
- Decorative escutcheons standard on both sides
- Hardened steel armor plate reinforcement shield withstands drilling
- Single strike, ASA115, for both bolts
- Handed-RH or LH (because of type of strike)

Discontinued by factory-Call for closeout prices

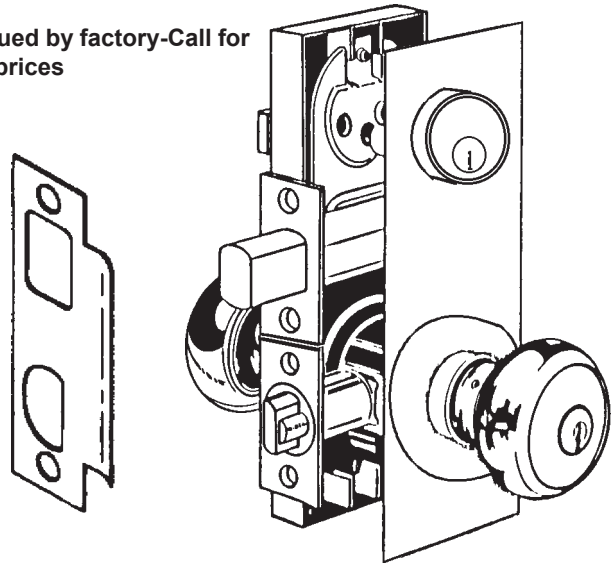

SPECIFICATIONS

DOOR THICKNESS: 1-3/8" to 1-3/4"
BACKSET: 2-3/4" Square Corner Face
BOLT THROW: 1"
BORE: Top Hole: 1-1/4"
 Middle Hole: 1-5/8"
 Bottom Hole: 2-1/8"
ROSE: 2-9/16"
FINISHES: US-5A Antique Brass

K01TAC Specify Hand—LH or RH

PASSAGE SET: Inside and outside knob always free. 1" deadbolt is activated by key from outside or thumbturn on inside. Turning inside knob retracts both bolts simultaneously. To enter, retract deadbolt by key and turn outside knob.

K11TAC Specify Hand—LH or RH

ENTRANCE LOCKSET: Outside knob locked by turn button in inside knob. Inside knob always free. Turn button must be manually returned to unlocked position to release outside knob. 1" deadbolt is activated by key in deadlock outside, or by thumbturn inside. Turning inside knob retracts both deadbolt and latchbolt simultaneously. To enter, open deadbolt by key first, then by key in knob for latchbolt.

KEY BLANKS

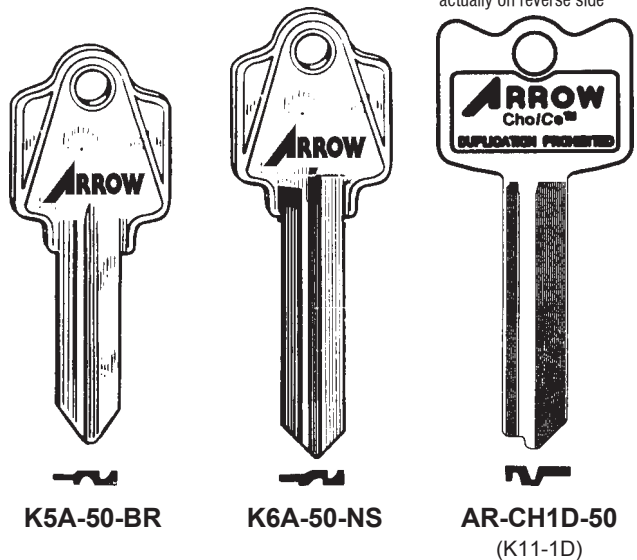

REPLACEMENT CYLINDER PACKS IN COMPETITIVE KEYWAYS

Discontinued - call for closeout prices

Each pack contains:
 1 brass cylinder, 2 brass key blanks-(5 pin), and Appropriate tailpiece(s)

CYLINDER PACKS—

Pack No.	Description
PK96C	D60 & E60 Series, except double cyl. 1-3/8" or 1-3/4" door
PK96DC	D60 & E60 Series, double cyl. 1-3/8" or 1-3/4" door
PK100C	H, ML, MK Series, Knob or Lever Lock

KEYWAYS: A(Arrow); CS(C keyway); ES(E keyway)
FINISHES: US-4 or US-26D

TO ORDER:

Specify	Pack No.	Keyway	Finish
	PK100C	CS	US-4

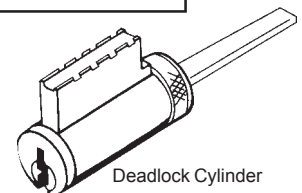
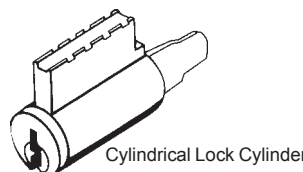

©ZIPF LOCK COMPANY

ARROW

CYLINDERS

Mortise Cylinders

Standard
Straight
Cam

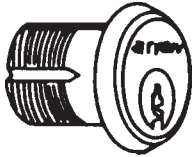

MC61 1-1/8"
US-26D
6 pin

FINISHES: US-3 Polished Brass
US26D Satin Chrome



Rim Cylinders

Discontinued - call for closeout prices

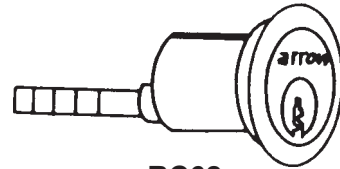

RC62
US-3, 26D
6 pin
Specify Finish

INTERCHANGEABLE CORE CYLINDERS (Less Cores)

FINISHES: US-10 Satin Bronze
US-10B Oil Rubbed Bronze
US26D Satin Chrome

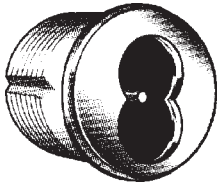

MORTISE CYLINDER
AR-C16CR-16 1-1/8" 6 pin
AR-C16CR-27 1-1/4" 6 or 7 pin
FINISH: US-10, 10B: w/Adams Rite Cam
US-26D: w/001 Standard Cam
1-1/8" only in US-26D

Tapered
Face

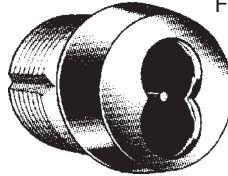

MORTISE CYLINDER
AR-C16CRT-27 1-1/4" 6 or 7 pin
w/Adams Rite Cam
FINISH: 613, US-26D

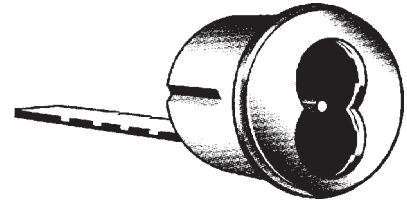

RIM CYLINDER
AR-C16RCR-16 6 pin
AR-C16RCR-27 6 or 7 pin
FINISH: US-10, 10B, 26D
10 & 10B discontinued- Call for
closeout prices

See next page for I/C core parts

INTERCHANGEABLE CORE

TAILPIECE ASSEMBLIES

AR-100CR-44-201* 6/7 pin tailpiece assembly for "H" Series IC
AR-550CR-44-201 6/7 pin tailpiece assembly for "MK" Series IC
AR-HSCR-44-201* 6/7 pin tailpiece assembly for "Q" & "ML" Series IC
*Will not fit 15 and 19 functions.

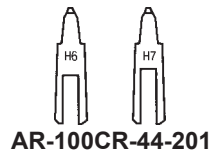

AR-100CR-44-201

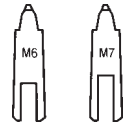

AR-550CR-44-201

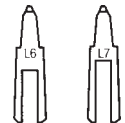

AR-HSCR-44-201

UNCOMBINED CORES

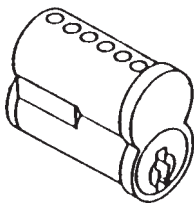

AR-C6S-UC-

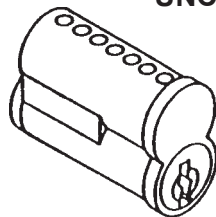

AR-C7S-UC-

Stock No.	Description
AR-C6S-UC-	6 pin core
AR-C7S-UC-	7 pin core

Keyways stocked:

ARROW: 1D

BEST: AB, BB, DB, EB, FB, GB, HB, JB, KB, MB

TO ORDER CORE, SPECIFY: Stock No. + Keyway Code + Finish = AR-C7S-UC-AB 26D

See next page for I/C core parts

ARROW

INTERCHANGEABLE CORE PARTS

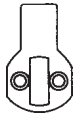

AR-001



AR-AM2

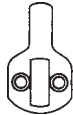

AR-004
N Series, Exit
Devices, Alarms



AR-006
Schlage



AR-18
Adams Rite

MORTISE HOUSING PARTS

<u>Stock No.</u>	<u>Description</u>
AR-3-48 X 3/16	Cam Set Screw
AR-C16CR-122	Washer
AR-C16CR-121A	Adaptor Assembly - 7 pin

LATCHES

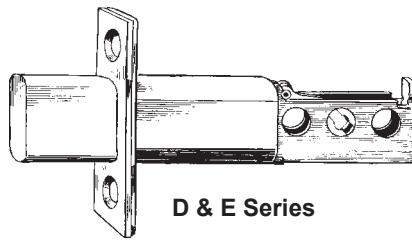

D & E Series

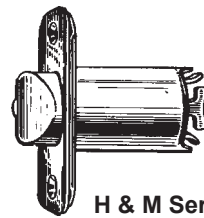

H & M Series

ARROW	2-3/8" Square Face	2-3/8" D.I.	2-3/4" Square Face	2-3/4" D.I.
D & E Series	ZL-334 (141)	ZL-336 (145)	ZL-335 (142)	ZL-337 (146)
D & E Series (1-1/8" Face)			ZL-335W* (144)	
H & Q Series Latch			\$ZL-421* (160)	
H & Q Series Deadlatch			ZL-298* (161)	
MK Series Latch	ZL-349 (101)			
MK Series Latch (1-1/8" Face)			ZL-350* (104)	
MK Series Deadlatch	ZL-99 (111)	ZL-320 (115)		ZL-321 (116)
MK Series Deadlatch (1-1/8" Face)			ZL-100* (114)	
MK Series Deadlatch (UL)			ZL-363* (124)	
ML & L Lever Series Latch (UL)	ZL-564 (271)		ZL-565* (274)	
ML & L Lever Series Deadlatch (UL)	ZL-566 (281)		ZL-567* (284)	

*Has 1-1/8" wide face.

EXIT DEVICES

S1250

Rim Exit Device

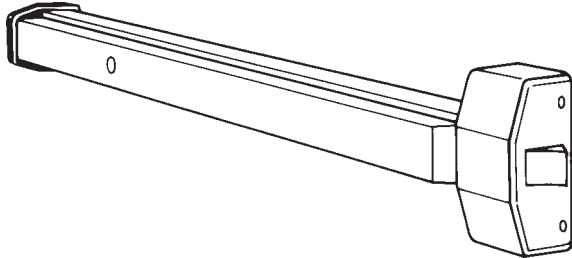

<u>Stock No.</u>	<u>Finish</u>
AR-S1250 AL	Powder Coat Aluminum
AR-S1250 BRZ	Powder Coat Bronze

Specifications

Conforms to ANSI A156.3 Type 1 Grade 1

For Doors	Wood or hollow metal 1-3/4" thick.
Stile	4-1/2" minimum stile.
Covers	Nonferrous alloy.
Chassis	Nonferrous alloy.
Rail Assembly	Steel. Furnished standard for doors 32" to 36".
End Cap	Metal.
Hand	Non handed.
Latch Bolt	3/4" throw stainless steel.
Strike	S38 strike, surface applied, standard for S1250. Not for fire exit hardware.
Dogging Feature	Hex key dogging standard. Cylinder dogging special order only.
UL/CUL Listed	For panic, standard.
Cylinder	Brass Material. SR & TA trim supplied standard with cylinder.
Finishes	AL - Powder Coat Aluminum BRZ - Powder Coat Bronze



S1250

Rim Exit Device Trims

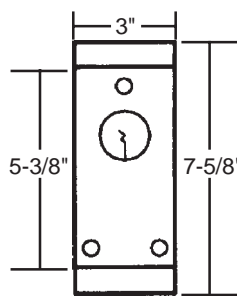

Trim is furnished with mortise nuts and screws for 1-3/4" doors. Covers 161 cutout.

<u>DESCRIPTION</u>	<u>Stock No.</u>	<u>Finish</u>
Blank Plate(no pull)	AR-SF01	AL
Pull w/o cyl. or hole	AR-SF02	AL or BRZ
Pull <u>with</u> cylinder	AR-SF12	AL or BRZ

•Specify Stock No. and Finish when ordering.



<u>DESCRIPTION</u>	<u>Stock No.</u>	<u>Stock No.</u>
Passage	—	AR-SR01
Storeroom	AR-TA12	AR-SR12
Storeroom-IC	—	AR-SR12-IC
Classroom	AR-TA17	AR-SR17
Classroom-IC	—	AR-SR17-IC

•Available in 26D-Dull Chrome finish only
IC=Interchangeable core. Furnished less core.

DON-JO

PULL PLATE FOR S1250

DJ-7015 ARROW 630

Stainless steel finish. Pull with cylinder hole. Cylinder not included. Plate is 3" x 13-1/2"

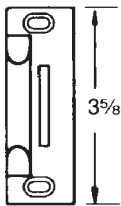
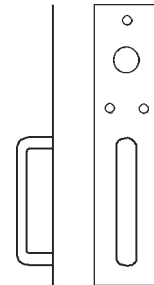

The S38 strike is the standard strike that is included in the S1250 Rim Exit Device.

Surface Applied
Nylon Coated

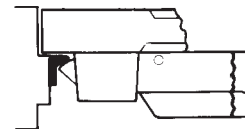

Minimum Stile Requirements
Single Door

4-1/2" MIN. STILE