

# ALUMINUM DOOR LOCKS



## MS1850S SERIES

### **DEADLOCK**

**FACE**—1" x 6-7/8"

**BOLT**—5/8" x 1-3/8" x 2-7/8", 1-3/8" throw, five ply laminated steel. Center ply has Alumina-Ceramic core to defeat hacksaws.

**CASE**—1" x 5-13/16"

**FINISH**— 313(121) Dark Bronze

335(119) Black

628(630) Satin Aluminum

**OPERATION**—360° turn of key (thumbturn) throws or retracts the counter balanced bolt. Accepts standard mortise cylinder with M.S. cam.

**NON-HANDED**

**LOCK ONLY** (Order faceplate and strike separately)

**MS-1853S-110** 7/8" Backset

**MS-1853S-210** 31/32" Backset

**MS-1853S-310** 1-1/8" Backset

**MS-1853S-410** 1-1/2" Backset

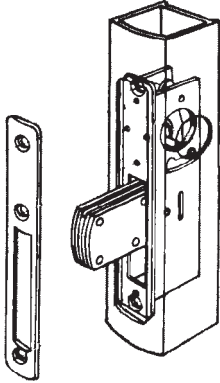

### **FACE PLATES** (Can only be ordered with lock)

 **24-0384-010** Flat

 **24-0384-110** Radius

 **24-0384-410** Radius w/strip

 **24-0384-210** Left Bevel\*

 **24-0384-310** Right Bevel\*

\*To determine hand: Face front of plate and look down at it from above.

**FINISH**— 313(121) Dark Bronze

335(119) Black

628(630) Satin Aluminum

### **HOW TO ORDER: Specify,**

Lock: **MS-1853S-110** 7/8" Backset

**And Face Plate/Finish (if needed)**

Face Plate: **24-0384-010** Flat

Finish: **628** Satin Aluminum

## MS1850S-050 SERIES

### **HOOKBOLT DEADLOCK**

**FACE**—1" x 6-7/8"

**BOLT**—5/8" x 1-3/8", 13/16" throw, five ply laminated steel. Center ply has Alumina-Ceramic core to defeat hacksaws.

**CASE**—1" x 6"

**FINISH**— 313(121) Dark Bronze

335(119) Black

628(630) Satin Aluminum

**OPERATION**—360° turn of key (thumbturn) throws or retracts the counter balanced bolt. Accepts standard mortise cylinder with M.S. cam

**NON-HANDED**

**LOCK ONLY** (Order faceplate and strike separately)

**MS-1853S-150** 7/8" Backset

**MS-1853S-250** 31/32" Backset

**MS-1853S-350** 1-1/8" Backset

**MS-1853S-450** 1-1/2" Backset

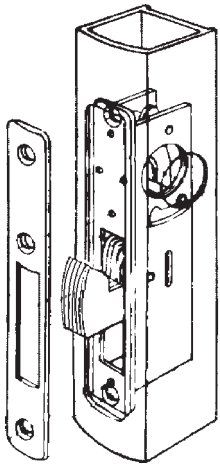

### **FACE PLATES** (Can only be ordered with lock)

 **24-0384-020** Flat

 **24-0384-120** Radius

 **24-0384-420** Radius w/strip

 **24-0384-220** Left Bevel\*

 **24-0384-320** Right Bevel\*

\*To determine hand: Face front of plate and look down at it from above.

**FINISH**— 313(121) Dark Bronze

335(119) Black

628(630) Satin Aluminum

# ALUMINUM DOOR LOCKS

Limited Supply

4713 is being replaced by 4513 & 4913. See chart.



## 4710 SERIES HEAVY DUTY DEADLATCH

**FACE**—1" x 6-7/8"  
**BOLT**—5/8" x 1", 1/2" throw, white bronze with hardened steel internal pins. Reversible.  
**CASE**—1" x 5-13/16"  
**FINISH**— 313(121) Dark Bronze  
           335(119) Black  
           628(630) Satin Aluminum  
**OPERATION**—Turn key or operate handle to retract spring-loaded latchbolt. To hold bolt retracted, push it in and secure by reverse turn of key.

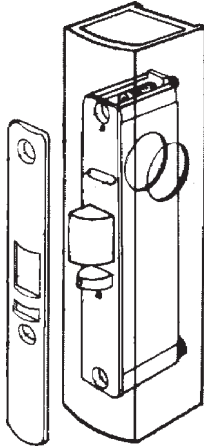

**LOCK ONLY** (Order faceplate and strike separately)

**Being Replaced by:**

- 4713-16 7/8" Backset ..... 4513-16  
 4713-26 31/32" Backset ..... 4513-26  
 4713-36 1-1/8" Backset ..... 4913-36  
 4713-46 1-1/2" Backset ..... 4913-46

### HOW TO ORDER: Specify,

Lock: 4713-16 7/8" Backset

And Face Plate and Finish (if needed)

Face Plate: 24-0017-1220 Radius

Finish: 628 Satin Aluminum

And Strike and Finish (if needed)

Strike: 4902-01 Flat

Finish: 630 Satin Aluminum

## 4530 (4730) SERIES REPLACEMENT DEADLATCH

**FACE**—1-1/4" x 7-13/32"  
**BOLT**—1/2" x 1", 1/2" throw, all metal with hardened steel internal pins. Reversible.  
**CASE**—1" x 5-13/16"  
**FINISH**— 313(121) Dark Bronze  
           335(119) Black  
           628(630) Satin Aluminum  
**OPERATION**—Turn key or operate handle to retract spring-loaded latchbolt. To hold bolt retracted, push it in and secure by reverse turn of key.

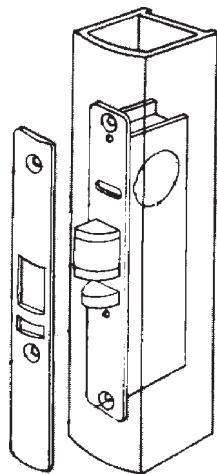

**LOCK ONLY** (Order faceplate and strike separately)



4533-16 7/8" Backset

4533-26 31/32" Backset

4533-36 1-1/8" Backset

**NOTE:** The 4733 locks are being replaced by the 4533 locks (rolling change)

### FACE PLATES (Can only be ordered with lock)

-  24-0017-0220 Flat  
 24-0017-1220 Radius  
 24-0017-4220 Radius w/strip  
 24-0017-2220 Left Bevel\*  
 24-0017-3220 Right Bevel\*

\*To determine hand: Face front of plate and look down at it from above.

**FINISH**— 313(121) Dark Bronze  
           335(119) Black  
           628(630) Satin Aluminum

### STRIKES

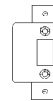





4902-01 Flat

4902-02 Radius

NOTE-4502 replaced by 4902

**FINISH**— 121(313) Dark Bronze  
           119(335) Black  
           630(628) Satin Aluminum

### FACE PLATES (Can only be ordered with lock)

-  24-0016-020 Flat  
 24-0016-120 Radius  
 24-0016-220 Left Bevel\*  
 24-0016-320 Right Bevel\*

\*To determine hand: Face front of plate and look down at it from above.

**FINISH**— 313(121) Dark Bronze  
           335(119) Black  
           628(630) Satin Aluminum

### STRIKES



4901-01 Flat

4901-02 Radius

NOTE-4501 replaced by 4901

**FINISH**— 121(313) Dark Bronze  
           119(335) Black  
           630(628) Satin Aluminum

©ZIPF LOCK COMPANY

# ALUMINUM DOOR LOCKS

**ANSI/BHMA TYPE E8231**  
**Grade 1**

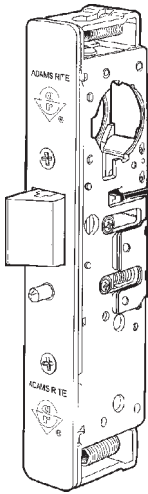

**4900 SERIES**

**HEAVY DUTY DEADLATCH**

**FACE**—1" x 6-7/8"

**BOLT**—5/8" x 1", 5/8" throw, solid brass. Reversible.

**CASE**—7/8" x 5-13/16"

**FINISH**— 313(121) Dark Bronze

335(119) Black

628(630) Satin Aluminum

**OPERATION**—Turn key or operate handle to retract spring-loaded latchbolt. To hold bolt retracted, push it in and secure by reverse turn of key.

**LOCK ONLY** (Order faceplate and strike separately)

**4913-36** 1-1/8" Backset

**4913-46** 1-1/2" Backset

**FACE PLATES** (Can only be ordered with lock)



**24-0137-01** Flat



**24-0137-02** Radius



**24-0137-03** Radius w/strip

The above face plates can be adjusted in the field for right or left beveled edged doors.

**FINISH**— 313(121) Dark Bronze

335(119) Black

628(630) Satin Aluminum

**Replaces 4713-36 and 4713-46**

**HOW TO ORDER: Specify,**

Lock: **4913-36** 1-1/8" Backset

**And Face Plate and Finish (if needed)**

Face Plate: **24-0137-01** Flat

Finish: **628** Satin Aluminum

**And Strike and Finish (if needed)**

Strike: **4902-01** Flat

Finish: **630** Satin Aluminum

**STRIKES**

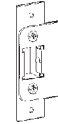

**4902-01** Flat

**4902-02** Radius

**FINISH**— 121(313) Dark Bronze

119(335) Black

630(628) Satin Aluminum

Accommodates the 1/2" wide latch bolt of 4500/4700 latches and 5/8" wide latch bolt of the 4900 series by removing snap-in nylon insert

**4500 SERIES**

**HEAVY DUTY DEADLATCH**

**FACE**—1" x 6-7/8"

**BOLT**—5/8" x 1", 1/2" throw. Reversible.

**CASE**—1" x 5-13/16"

**FINISH**— 313(121) Dark Bronze

335(119) Black

628(630) Satin Aluminum

**OPERATION**—Turn key or operate handle to retract spring-loaded latchbolt. To hold bolt retracted, push it in and secure by reverse turn of key.

**LOCK ONLY** (Order faceplate and strike separately)

**4513-16** 7/8" Backset

**4513-26** 31/32" Backset

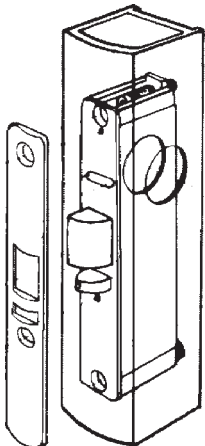

**FACE PLATES** (Can only be ordered with lock)



**24-0017-0220** Flat



**24-0017-1220** Radius



**24-0017-4220** Radius w/strip



**24-0017-2220** Left Bevel\*



**24-0017-3220** Right Bevel\*

\*To determine hand: Face front of plate and look down at it from above.

**FINISH**— 313(121) Dark Bronze

335(119) Black

628(630) Satin Aluminum

**Replaces 4713-16 and 4713-26**

**STRIKES**

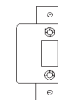

**4902-01** Flat

**4902-02** Radius

**FINISH**— 121(313) Dark Bronze

119(335) Black

630(628) Satin Aluminum

# ALUMINUM DOOR LOCKS

## ADAMS RITE

### 4070 SERIES DEADLOCK

**FACE**—1" x 5 5/8"  
**BOLT**—5/8" x 1-1/4" x 5/8" throw.  
**CASE**—27/32" x 4-1/2"  
**FINISH**—628 Satin aluminum  
**OPERATION**—180° turn of key (thumbturn) projects or retracts bolt. Accepts standard mortise cylinder with M.S. cam.  
**NON-HANDED**

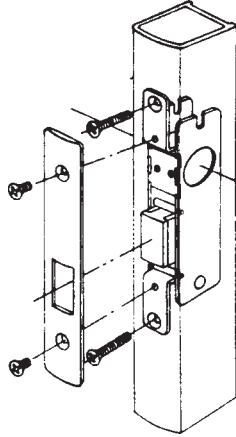

#### Complete Lock

**4070-10** 7/8"  
**4070-20** 31/32"  
**4070-30** 1-1/8"

### MS1847 SERIES DEADLOCK (SLIDING DOOR)

For metal/glass patio doors—  
**CASE**—1/2" X 3-3/16" X 1-1/8"  
**FACE**—Rectangular or full radiused ends.  
**BOLT**—Three ply laminated stainless steel. Designed to withstand approximately 1/2 ton force, either horizontal or vertical.  
**OPERATION**—45° turn of turn lever, ordered separately.

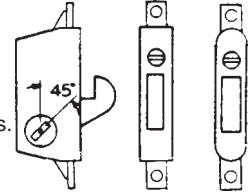

#### Stock No.

**MS1847** Rectangular face  
**MS1847-02** Radiused face

### 4568 HANDLE EUROSTYLE

For 4700 Series Latches  
**LEVER** —4.65"  
**ESCUTCHEON**—1.34" x 3.95"  
 Reversible, furnished with 4580 cam plug.

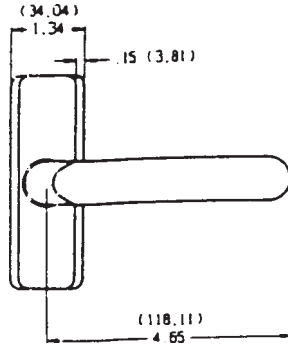

#### Stock No.

**4568 313** Bronze Anodized  
**4568 628** Satin Aluminum

Discontinued. Call for closeout prices.

### 1000 SERIES TURN SERIES

For MS1847 above—  
**SPINDLE**—Hardened steel, plated for corrosion resistance.  
**LENGTH**—1.86"  
**TURN LEVER**—Zinc alloy  
**FINISH**—US-26D Satin chrome  
**ESCUTCHEON**—Steel

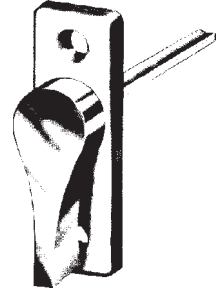

#### Stock No.

**1000-11-32-682** Parallel Drive  
**1000-21-32-682** Perpendicular Drive

### 4590 HANDLE DEADLATCH PADDLE

For 4700 Series Latches  
 The -02 function is stocked, but paddles are reversible for left/right and push/pull.

Furnished with 4580 cam disc, shown below.

An alternative to knob or lever handle; makes opening a latched door as natural as opening an unlatched one—just push or pull in the direction the door swings. Available for any Adams-Rite Series 4700 deadlatch (except 4750).

#### Stock No

**4590-02 313** Bronze Anodized  
**4590-02 628** Satin Aluminum

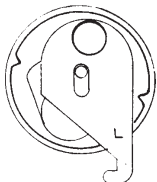

4590 paddle handles include 4580 cam disc pictured at left.

Stock#	Operation	Use
4590-01	Pull to Left	Outside of left hand reverse door or inside of right hand.
4590-02	Push to Left	Outside of left hand door or inside of right hand reverse.
4590-03	Pull to Right	Outside of right hand reverse door or inside of left hand.
4590-04	Push to Right	Outside of right hand door or inside of left hand reverse.

LH	RH
LHR	RHR

# ALUMINUM DOOR LOCKS

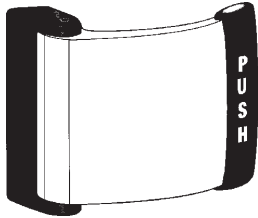

## PULL HANDLE FOR 4700 SERIES LATCHES

**Stock No.**

- 4591-02 613** Bronze Anodized
- 4591-02 628** Satin Aluminum

Same features as 4590 paddle handle on previous page. For 4700 series latches. Field adjustable for push/pull, LH/RH.

## MS DEADBOLT HANDLE FOR MS1850S, MS1950, MS1837 (not MS1890 or 7/8" backset)

**Stock No.**

*-Left Hand Reverse*

- 4550 121 LH** Dark Bronze (313)
- 4550 130 LH** Clear Anodized (628)

*-Right Hand Reverse*

**Use above handle. Field reversible.**

**Housing:** Aluminum casting is 1-3/8" wide x 7-1/2" long x 1" deep. Attached to door with 4 #10 screws.

**Operation:** Turn lever downward 90° to unlock. When released, lever returns to horizontal. Turn lever upward 90° to relock. Key operation from outside is not affected. Clutching action prevents damage to internal components.

**Function:** Easily unlock any MS® deadbolt by approximately 3 lbs. downforce on the 3" lever. Indicator signals lock status. Can be installed in place of existing key cylinder or cylinder type thumbturn on inside of door.

**Indicator:** "LOCKED" in red letters or "OPEN" in black letters appear on white background when lock is thrown or retracted. Indicator is driven by bolt itself.

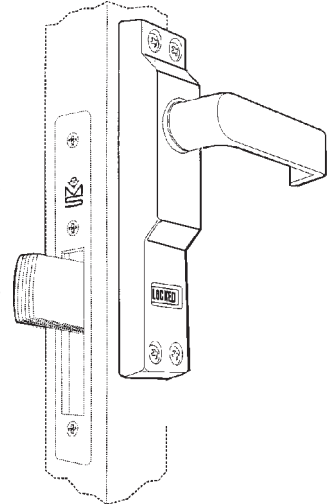

Lock & door frame not included.

## PULL HANDLE FOR 4500,4700,8400

**Stock No.**

*-Right Hand Reverse*

- 4593-07 121** Dark Bronze (313)
- 4593-07 130** Clear Anodized (628)

*-Left Hand Reverse*

- 4593-08 121** Dark Bronze (313)
- 4593-08 130** Clear Anodized (628)

Pull handle for narrow, medium or wide stile aluminum doors. Activates 4500, 4700, and 8400 series latches. Two modes of operation: 1) Door remains latched with free entry by latch pull, or 2) Entry by key only, with door re-locking after each use. **121(313)-Dark Bronze; 130(628)-Clear Anodized**

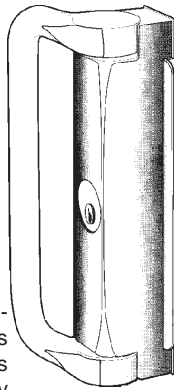

## REPLACEMENT STRIKES

*The 4501 & 4502 are being replaced by 4901 & 4902*



**Stock No. Long Type Strike**

- 4501-01** Flat, with dust box and mounting plate(4730)
- 4501-02** Radius, with dust box and mounting plate(4730)

**Stock No. Short Type Strike**

- 4502-01** Flat, with dust box and mounting plate(4710)
- 4502-02** Radius, with dust box and mounting plate(4710)

- FINISH—** **121(313)** Dark Bronze  
**119(335)** Black  
**630(628)** Satin Aluminum

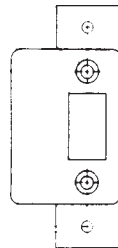

## ARMORED STRIKE PLATE

*With Reinforcement*

**Stock No. (Limited)**

- MS-4002-012** Flat
- MS-4002-112** Radius

For all standard M.S. locks with 1-3/8" bolt throw. Trim plate has .15 radius corners.

- FINISHES:** **313** Dark Bronze  
**628** Satin Aluminum

**Discontinued. Call for closeout prices.**

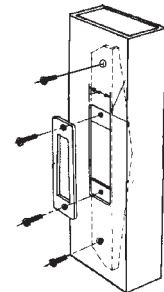

## 4580 CAM DISC

**Stock No.**

- 4580** Cam disc, reversible.

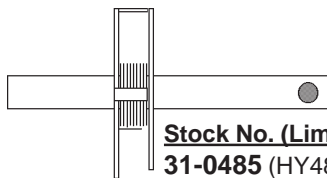
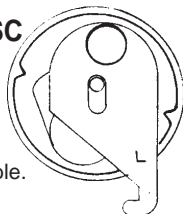

**Stock No. (Limited Supply)**

- 31-0485 (HY485)** Spindle for 4160 handle.

**Stock No. (Limited Supply)**

- 28-0064-02** Right Hand
  - 28-0064-03** Left Hand
- Replacement spring for 4160 handle.



# ALUMINUM DOOR LOCKS

**10 YEAR WARRANTY ON HOOK BOLT, DEADLOCK, DEADLATCH AND PADDLES**

*Cylinders, faceplates and levers not included - order separately.*

## BODIES ONLY

### SPECIFICATIONS

**FUNCTION:** Deadbolt, Hookbolt, Deadlatch

**BACKSET:** 31/32", 1-1/8", 1-1/2" - TH1101 not 1-1/2"

**HAND:** Non-handed, easily reversible

**FACE PLATE:** 1"W x 6-7/8"L Aluminum

**CASE DIMENSIONS:** 7/8"W x 6"L

### LATCHBOLT:

Deadbolt 5/8"W x 2-7/8"L x 1-3/8" throw

Hookbolt 5/8"W x 1-3/8"L x 13/16" throw

Deadlatch 1/2"W x 1.0"L x 1/2" throw

**DEADLATCHES:** Zinc alloy latchbolt with Delrin plastic insert, auxiliary bolt zinc diecast, deadlocks latchbolt and prevents manipulation.

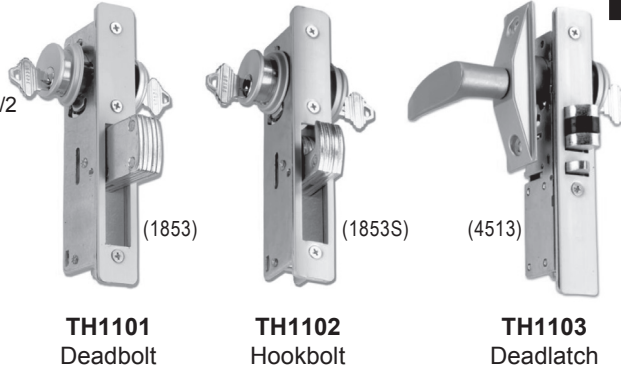

### Stock No.

*Deadbolt-*  
**TH1101 31/32"**  
**TH1101 1-1/8"**  
*Hookbolt-*  
**TH1102 31/32"**  
**TH1102 1-1/8"**  
**TH1102 1-1/2"**  
*Deadlatch-*  
**TH1103 31/32"**  
**TH1103 1-1/8"**  
**TH1103 1-1/2"**

**F  
A  
C  
E  
P  
L  
A  
T  
E  
S**

Deadbolt	<b>TH1100-FP1</b>	<b>TH1100-FP2</b>	<b>TH1100-FP3</b>	<b>TH1100-FP4</b>	<b>TH1100-FP5</b>
Hookbolt	<b>TH1100-FP6</b>	<b>TH1100-FP7</b>	<b>TH1100-FP8</b>	<b>TH1100-FP9</b>	<b>TH1100-FP10</b>
Deadlatch	<b>TH1100-FP11</b>	<b>TH1100-FP12</b>	<b>TH1100-FP13</b>	<b>TH1100-FP14</b>	<b>TH1100-FP15</b>
	FLAT	LEFT HAND BEVEL	RIGHT HAND BEVEL	RADIUS	RADIUS WITH WEATHERSTRIP



**Keyed Cylinder**

TH1100-ZC AL or DU



**Dummy Cylinder**

TH1100-DUM AL or DU



TH1100-ST2



**Anti-wrench cylinder guard**

TH1100-CG1 AL or DU



**Thumbturn Cylinder**

TH1100-ZT AL or DU



**Thumbturn Cylinder**

TH1100-ZT0 AL or DU



TH1100-ST1



**Push/Pull Handle**

TH1100-PUSH AL or DU

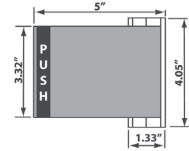

**Paddle:** Extruded Aluminum.

**Housing:** Zinc alloy, black hard coat finish.

**Operating assembly:** Steel mechanism.

**Hand:** Non-handed, cam plug included - reversible.

**Standard package:** Paddle arm, operating housing, binder post, cam plug, self adhesive decals and mounting hardware.

**Finish:** AL-Aluminum, DU-Duronotic.

### APPLICATION

For use with TH1103 deadlatch or any other brand of narrow stile mortise deadlatch. Paddle is **FOUR WAY REVERSIBLE**, select application required by referring to the chart below. Handing can be reversed on cam plug by removing C-clip and flipping the cam over and reinstalling C-clip.

### Universal - 4 Way Reversible

TYPE	OPERATION	USE
PULL - L.H.		Outside of left hand reverse door or inside of right hand
PUSH - L.H.		Outside of left hand door or inside of right hand reverse
PULL - R.H.		Outside of right hand reverse door or inside of left hand
PUSH - R.H.		Outside of right hand door or inside of left hand reverse

### Lever Handle

TH1100-LH1 AL or DU



**Lever:** Aluminum alloy cast.

**Escutcheon:** Aluminum 1-3/8" x 4", heavy duty spring mechanism prevents sagging of lever handle.

**Spindle:** Wrought steel, 1/4" square hardened heat treated.

**Hand:** Non-handed, easily reversible.

**Operation:** Turning lever downward will activate deadlatch.

**Standard package:** Cam plug included, all mounting screws, templates and installation instructions.

**Finish:** AL-Aluminum, DU-Duronotic.

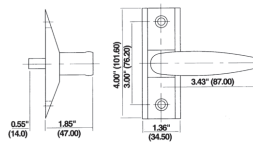

### APPLICATION

For use with TH1103 deadlatch or any other brand of narrow stile mortise deadlatch. Lever is **REVERSIBLE**, Handing can be reversed on cam plug by removing C-clip and flipping the cam over and reinstalling C-clip. Cam plug is secured to lever by 2 hardened steel pins. Cam plug locks into deadlatch by use of set screws in deadlatch.

©ZIPF LOCK COMPANY